

ABSTRACT

A thermal analysis has been performed on the FNAL proposed 3.9GHz HOM coupler design using finite element analysis (FEA), incorporating fully temperature dependent electrical and thermal conductivities. Complete cable and connector details have been included in the model. Nominal heat loads for both static (no RF power) and dynamic (average RF power) cases are reported at the 2K, 4.5K, 80K, and 300K junctions together with corresponding temperature profiles in the coupler and coaxial cable. A combination of different boundary condition scenarios have been analyzed and effects of cable size (x-section) and cable length on heat loads and temperatures is discussed.

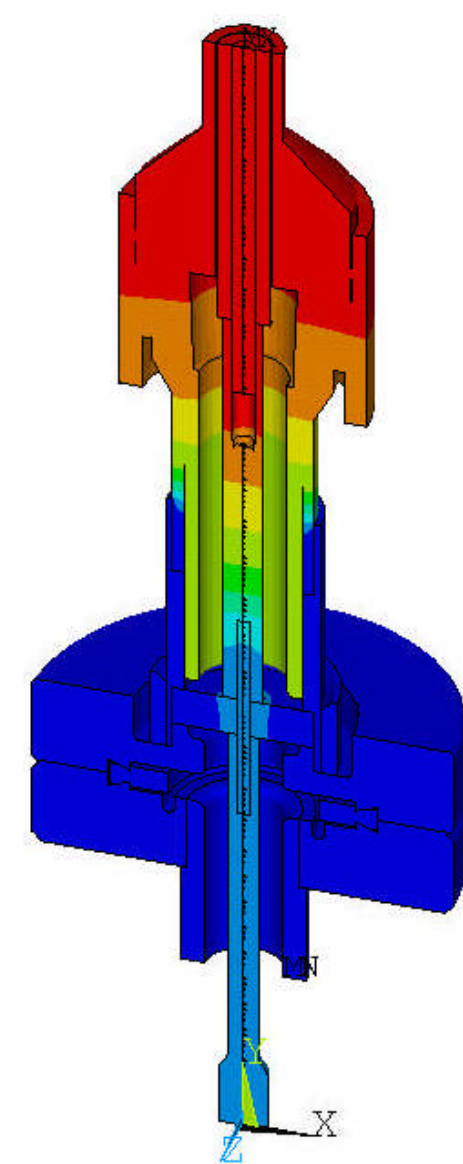

INTRODUCTION

An axisymmetric model of the HOM pickup coupler is shown in Fig. 1a. The coupler is a coaxial type, consisting of a vacuum-dielectric antenna portion at the cavity end connected to a commercially available RF coaxial cable that runs through the cryomodule and terminates at the exterior. Cable length is expected to vary anywhere between 1 and 2 meters. The cable plays a critical role, since its length and size determine heat loads into the cryogenic system and the temperature distribution within the coupler and cable itself. The coupler, for the most part, acts as a fixed boundary condition at one end of the cable (Fig. 1c). Cable length and size (diameter) play conflicting roles when it comes to minimizing heat loads and temperatures. A large diameter short length cable is ideal for minimizing RF losses, but provides a fast path for heat in from the outside. Longer cable lengths make it difficult to remove heat from the cable itself, which could lead to overheating of the cable. The aim is to determine the optimum combination of cable length and size that minimizes heat loads and keeps temperatures within acceptable limits.

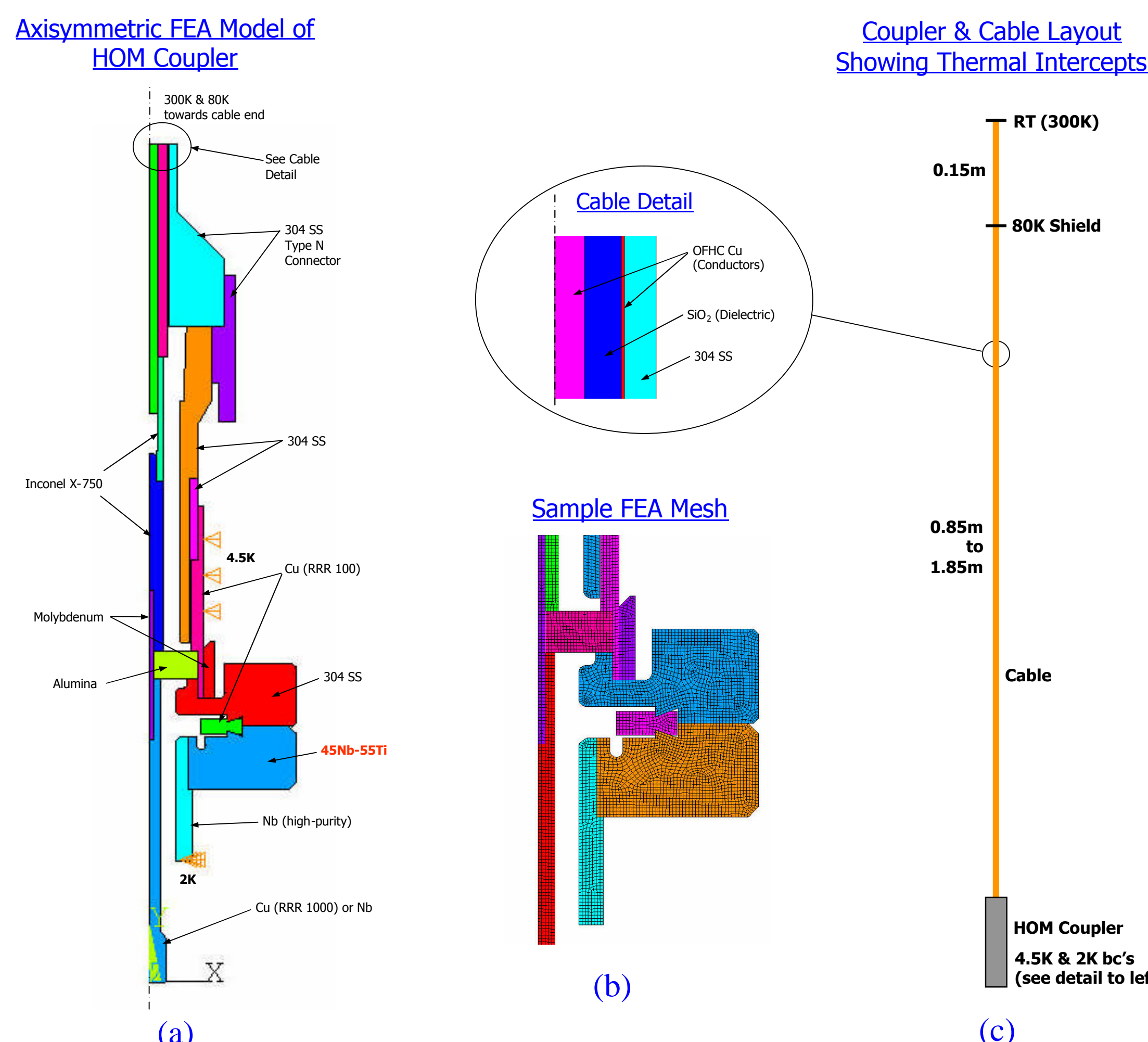

Figure 1: Axisymmetric FEA Model of FNAL HOM Coupler, showing cable section details, FEA mesh, and thermal intercepts.

Table 1: Cable Specifications & Sizes Studied

Cable Component	Material	Cable Size (mm)	
		Small dia	Large dia
Inner Cond.	OFHC Cu	0.85 Dia.	1.88 Dia.
Dielectric	SiO ₂ (99.9%)	2.40 Dia	4.22 Dia
Outer Cond.	OFHC Cu	0.10 Th'k	0.10 Th'k
Jacket	304 SS	3.18 Dia	6.40 Dia

MODEL SETUP

The coupler, connector, and cable were modeled in ANSYS as a 2-D axisymmetric geometry. The geometry was processed and meshed with PLANE77 higher order 8 node elements. To ensure accuracy, the mesh was kept very fine at all regions (Fig. 1b). All thin gaps for brazing were filled with the parent material, thereby assuming perfect thermal contact. Perfect thermal contact was also assumed at all shared boundaries (i.e. common nodes on all boundaries). Four different cable lengths (0.5m, 1m, 1.5m, 2m) and two different cable sizes (Table 1) were analyzed. Fully temperature dependent thermal conductivities were employed for all materials. (Note: thermal data for Nb-55Ti was unavailable and Nb-65Ti properties were used instead).



3.9 GHz HOM Coupler & Coaxial Cable Thermal FEA

S. Tariq, T. Khabiboulline

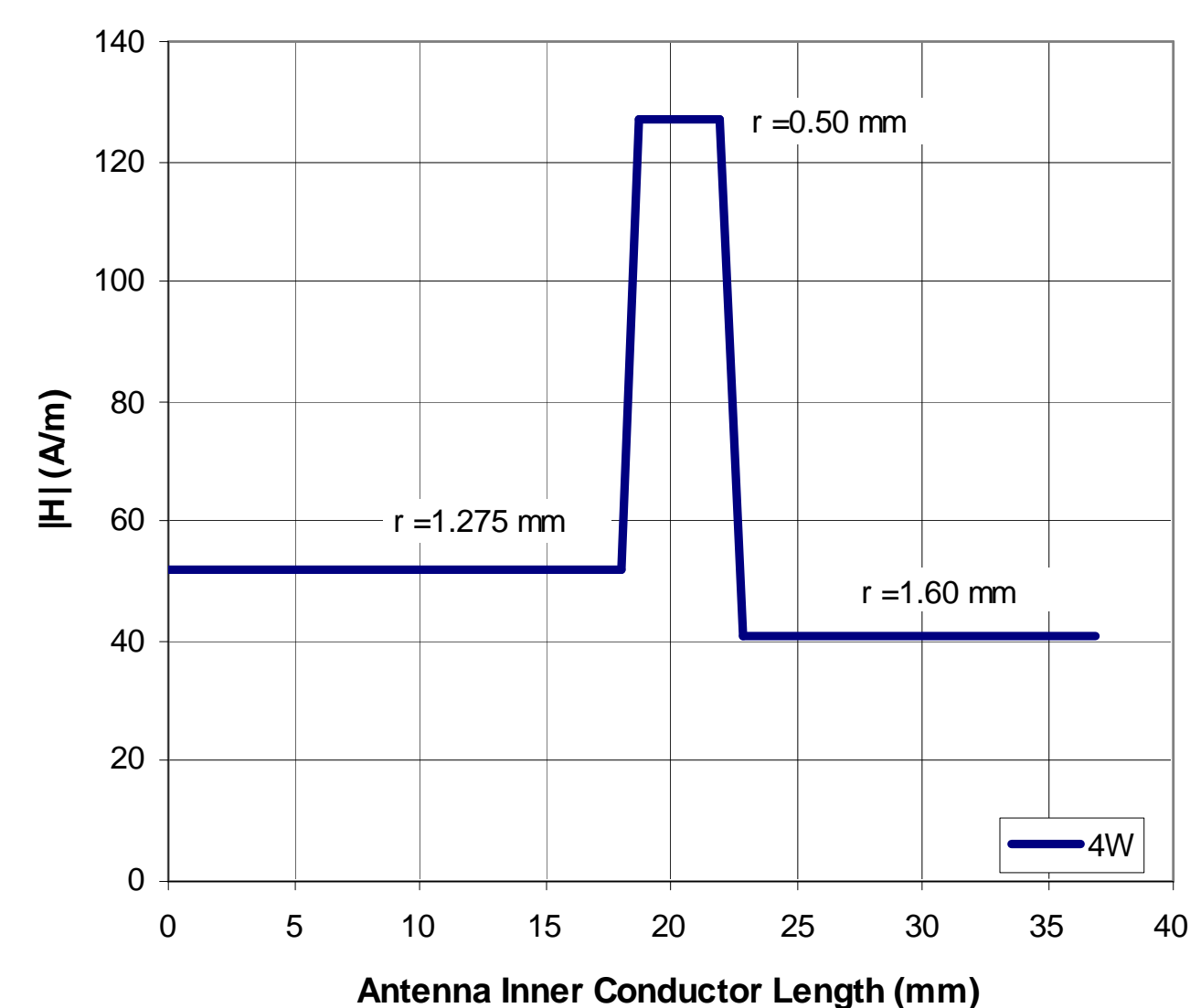

Figure 2: Magnetic field intensity in the antenna (inner conductor) at 4W power.

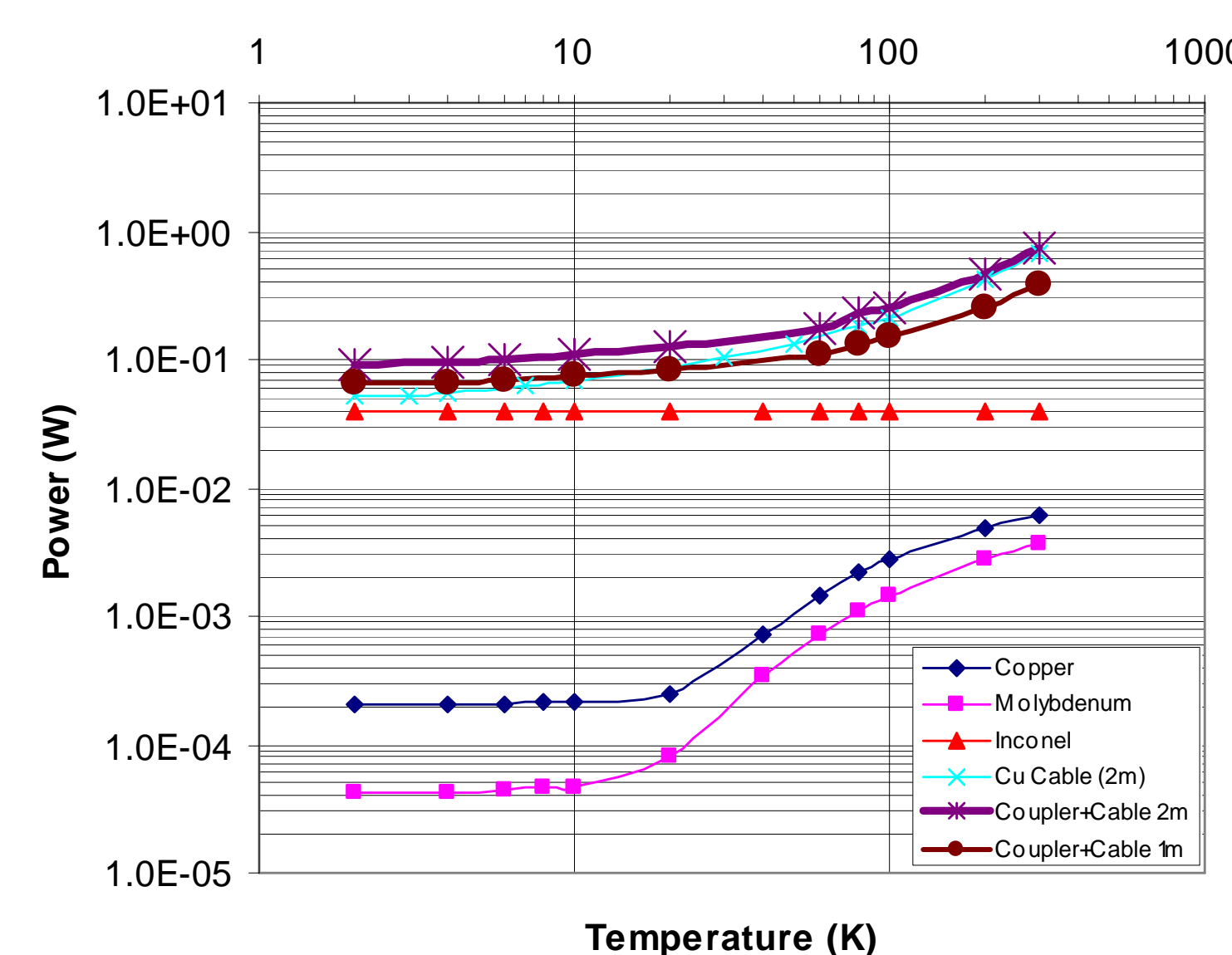

Figure 3: Power losses (4W RF) in coupler antenna (Cu, Mo, & In) and coaxial cable (medium dia) as a function of temperature. Also shown is the total power loss for 1m and 2m cable lengths.

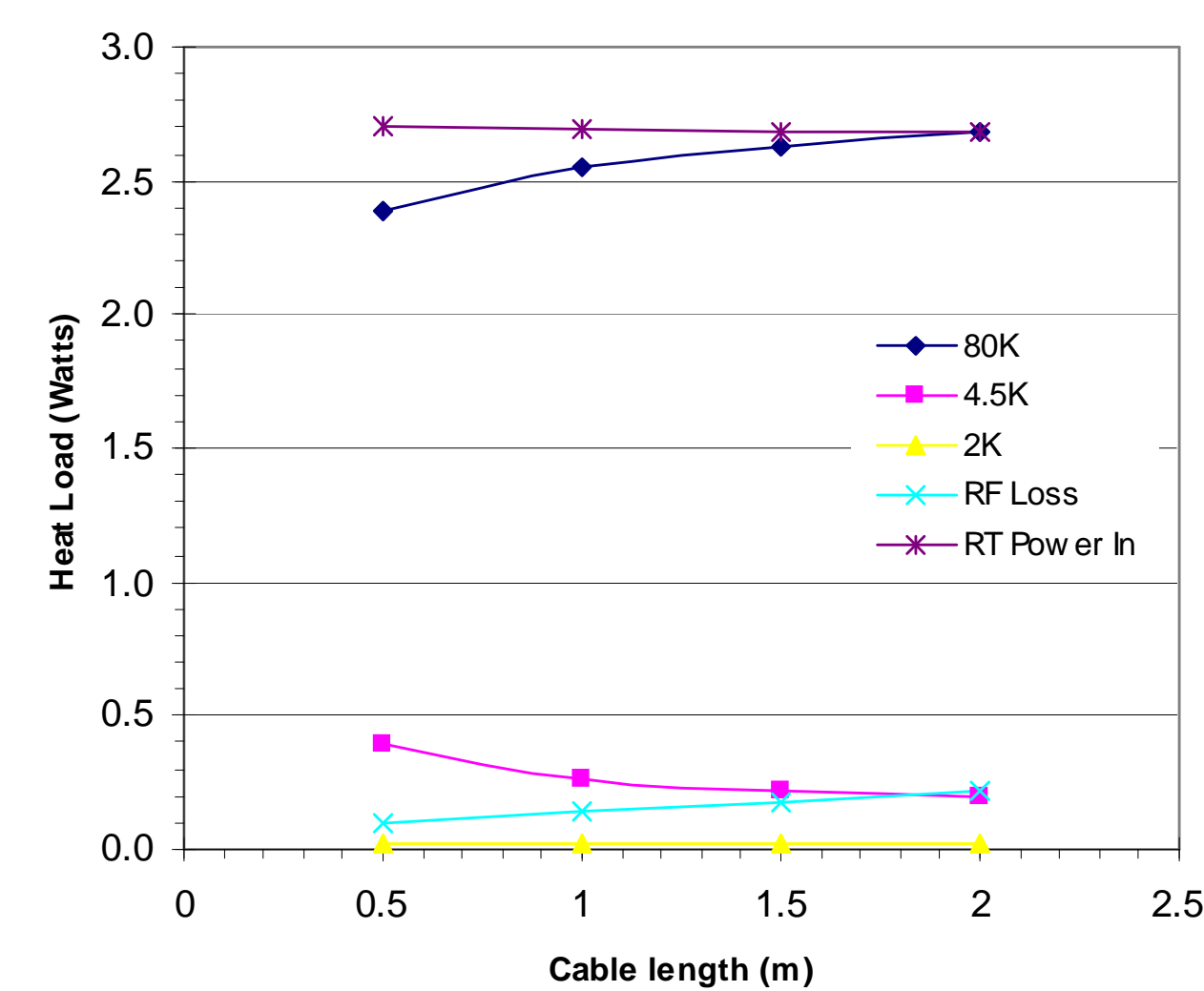

Figure 4: Dynamic heat loads as a function of cable length at the different junctions (4W RF, large dia. cable).

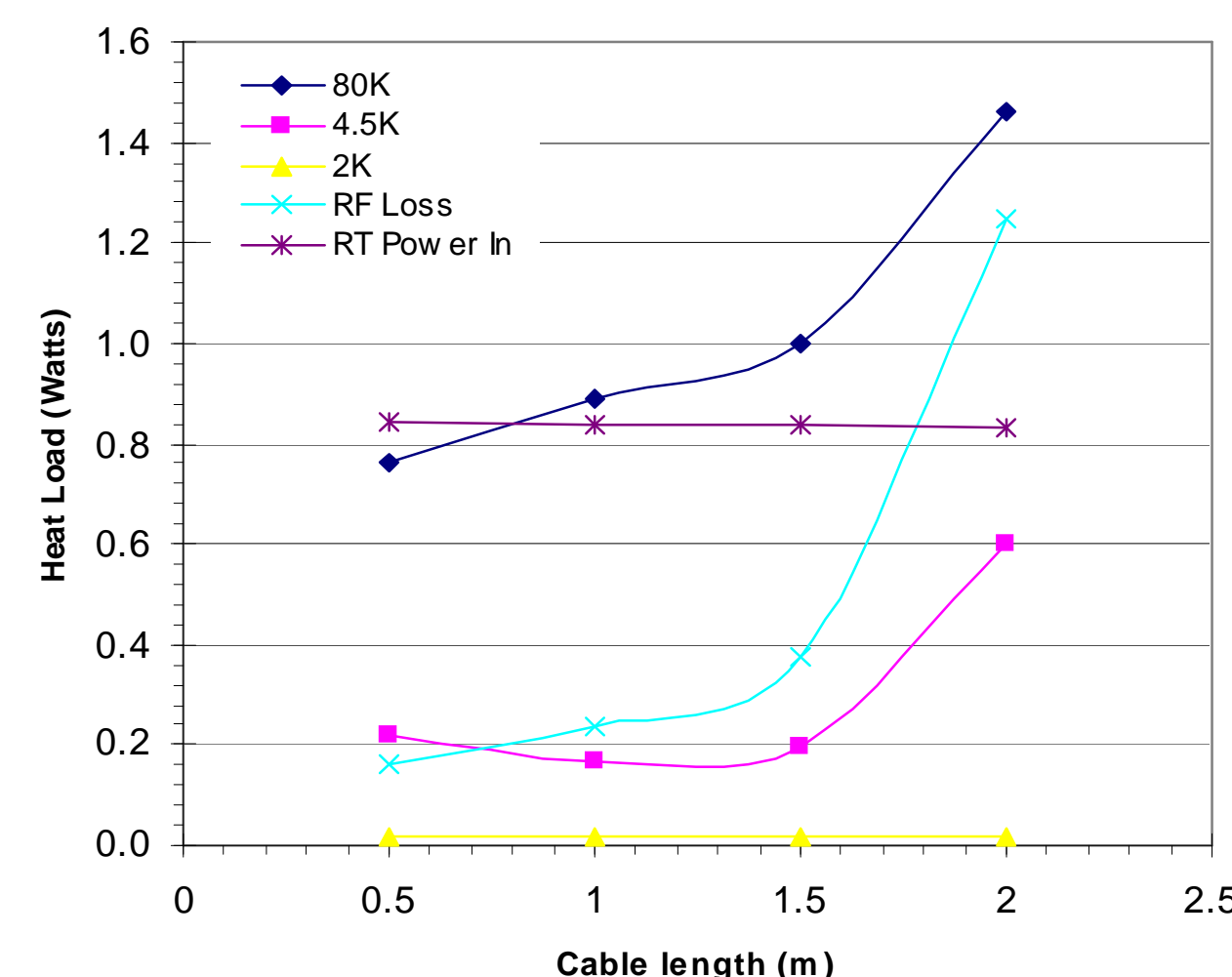

Figure 7: Dynamic heat loads as a function of cable length at the different junctions (4W RF, small dia. cable).

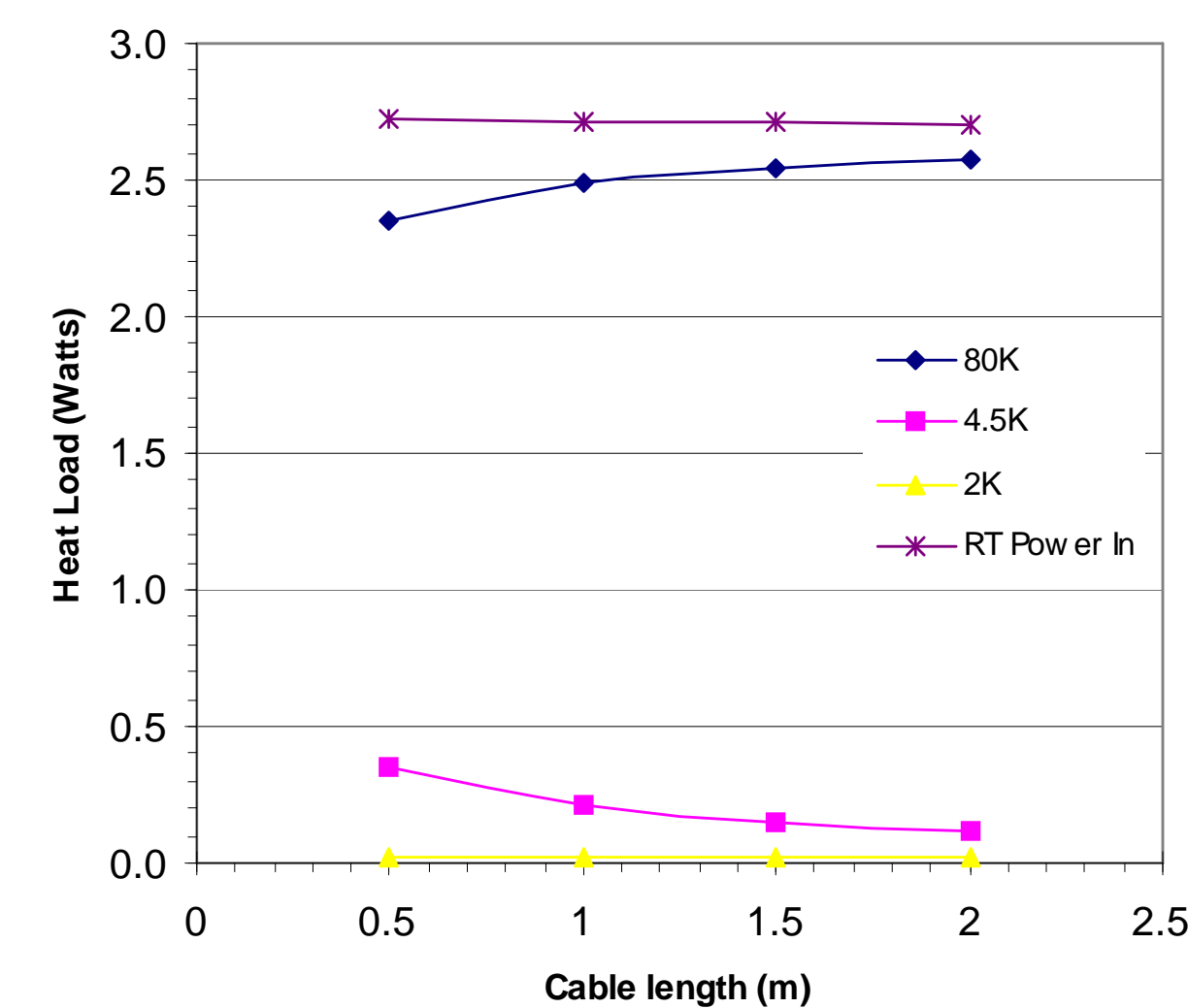

Figure 5: Static heat loads as a function of cable length at the different junctions (large dia. cable).

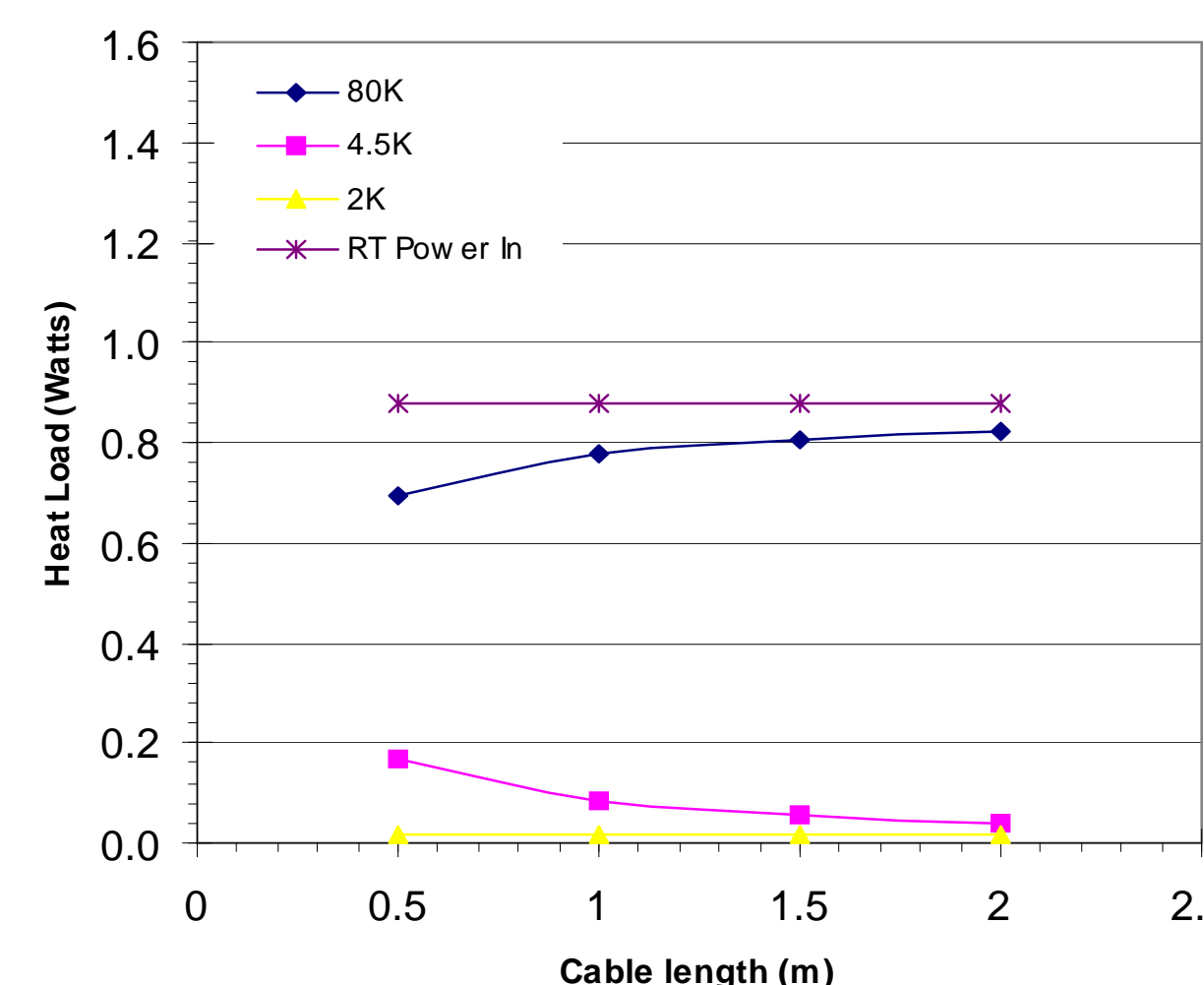

Figure 8: Static heat loads as a function of cable length at the different junctions (small dia. cable).

RF LOSSES AND THERMAL BOUNDARY CONDITIONS

RF losses on the conductor surface are given by Eq. (1), and the corresponding heat flux by Eq. (2). The magnetic field intensity distribution (|H|) in the antenna inner conductor based on 4W average power is given in Fig. 2. H values for the different conductor sizes and power conditions were scaled from these numbers. The electrical conductivity (σ) is highly temperature dependant, making the heat flux P'' also temperature dependent. Eq. (2) was thus evaluated at different temperatures and applied as a tabular boundary condition on the conductor surfaces (Fig. 3). Note that RF losses in the cable dominate, making cable size and length a critical part of this analysis.

Thermal boundary conditions are shown in Fig. 1. The room temperature end of the cable was maintained at 300K, and the 80K intercept was made at 0.15m from the cable end (based on routing through cryomodule), outer nodes of which were kept at 80K. At the coupler, the copper sleeve outer surface was maintained at 4.5K (tie-in to the 4.5K shield), and the Nb tube "cut" surface on the cavity end was kept at 2K. The cases where no 80K or 4.5K intercept is made were also investigated to see the effects on heat loads and temperatures. Due to cost considerations, heat loads to the 2K surface should be minimized, therefore a tie in to the 4.5K shield would be necessary.

The temperature dependence of the heat flux (RF loss) and thermal conductivity made this a highly nonlinear problem which required an iterative solution, the average run in ANSYS took about 8-15mins to solve depending on the test case being analyzed.

RESULTS

Fig.'s 4-9 show static and dynamic heat loads (4W RF) for the large and small cable diameters, and corresponding temperature distribution in the cable for different cable lengths. With the large dia. cable there is little difference between the static and dynamic cases since RF losses are low; however, significantly more heat is drawn into the 80K due to the larger x-section. Although RF losses are higher in the small dia. cable, overall heat loads are lower till about 1.5m cable length, after which heat loads rise dramatically (as the building heat cannot be removed fast enough due to the smaller x-section). This is seen by the temperature 'hump' in Fig. 9 at 2m length, where temperatures in the cable center reach 560K; maximum cable thermal rating is 1,223K (Note: material properties used were only up to 300K, so the actual maximum might even be higher).

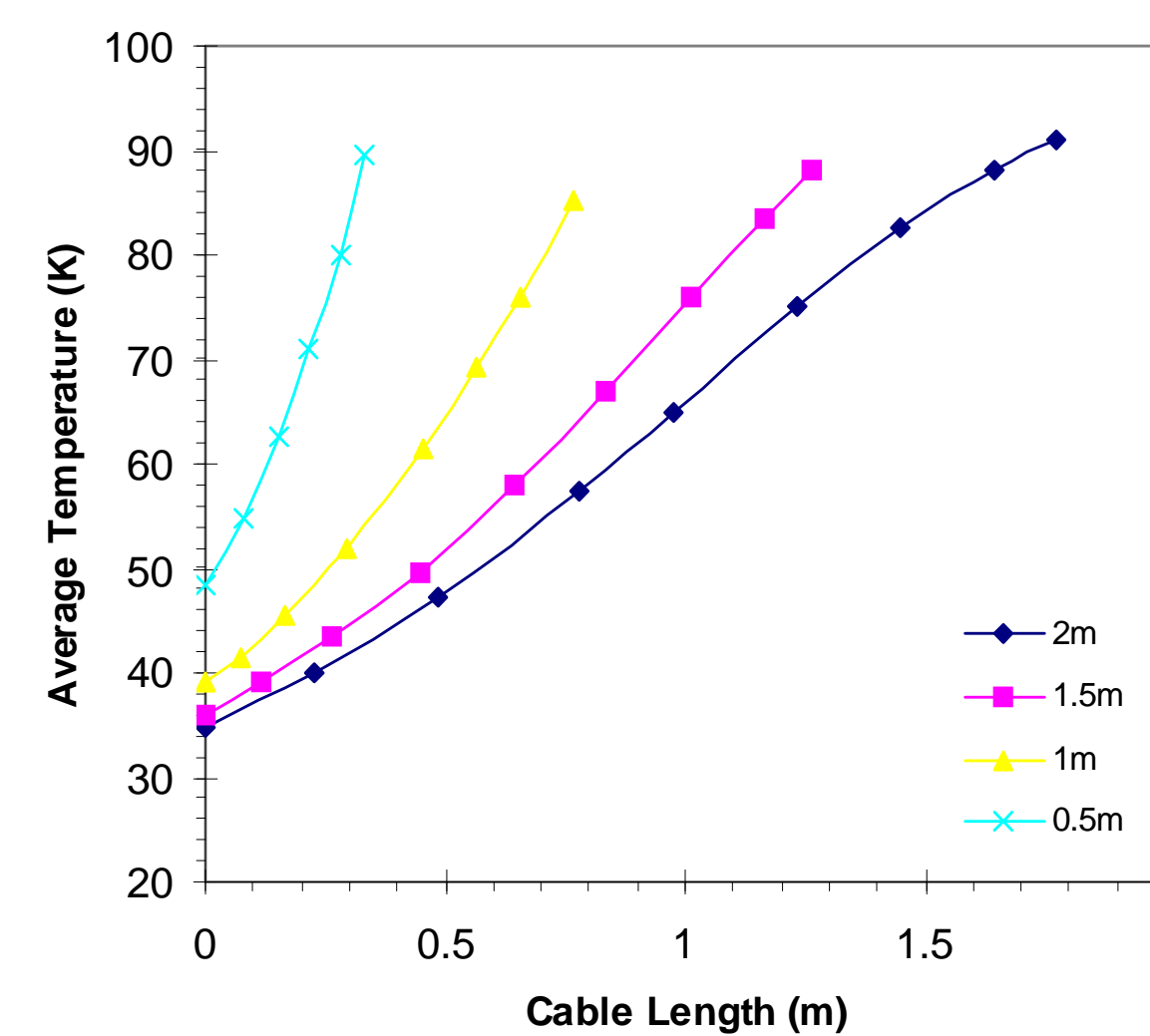

Figure 6: Dynamic temperature distribution in cable for different cable lengths up to 80K point (4W RF, large dia. cable).

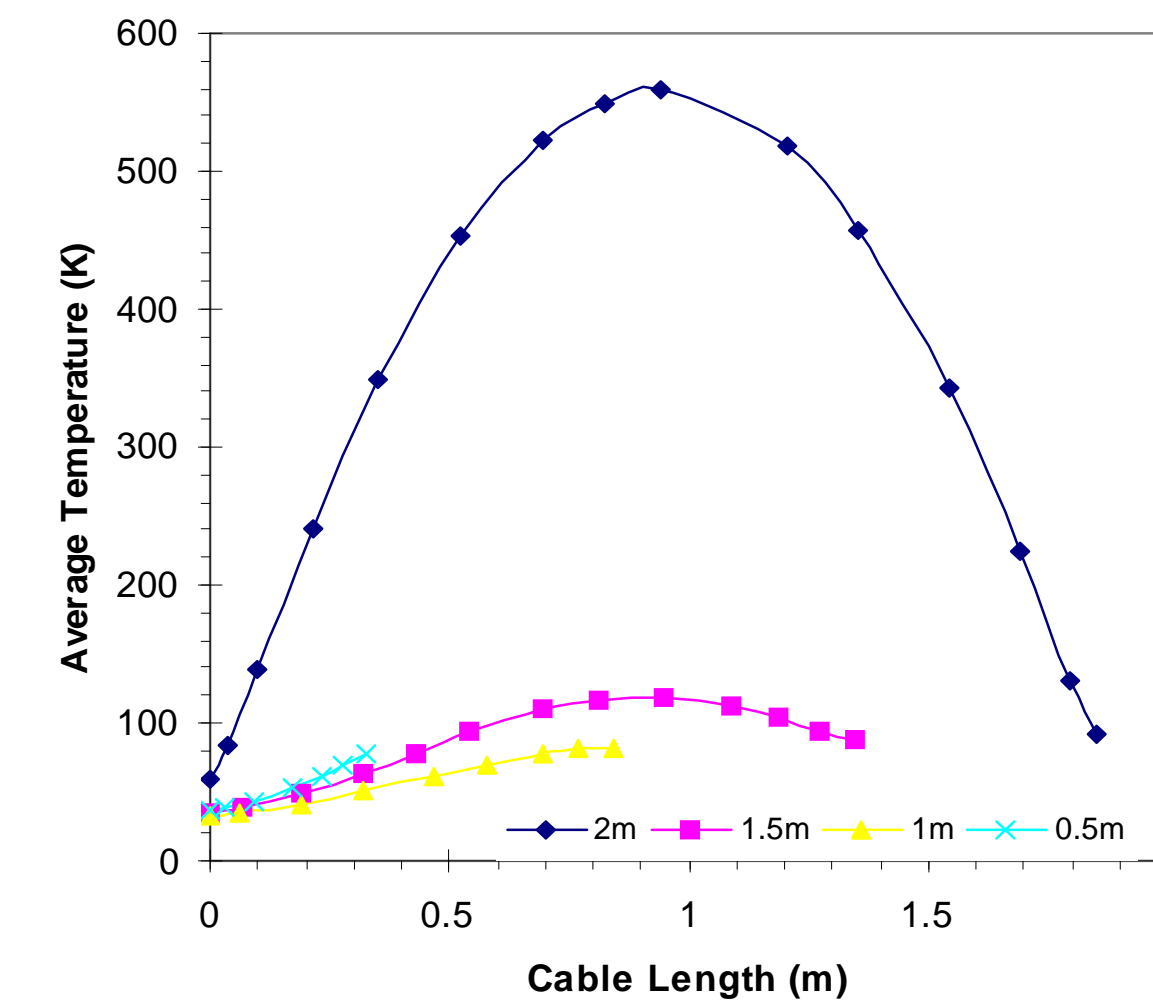

Figure 9: Dynamic temperature distribution in cable for different cable lengths up to 80K point (4W RF, small dia. cable).

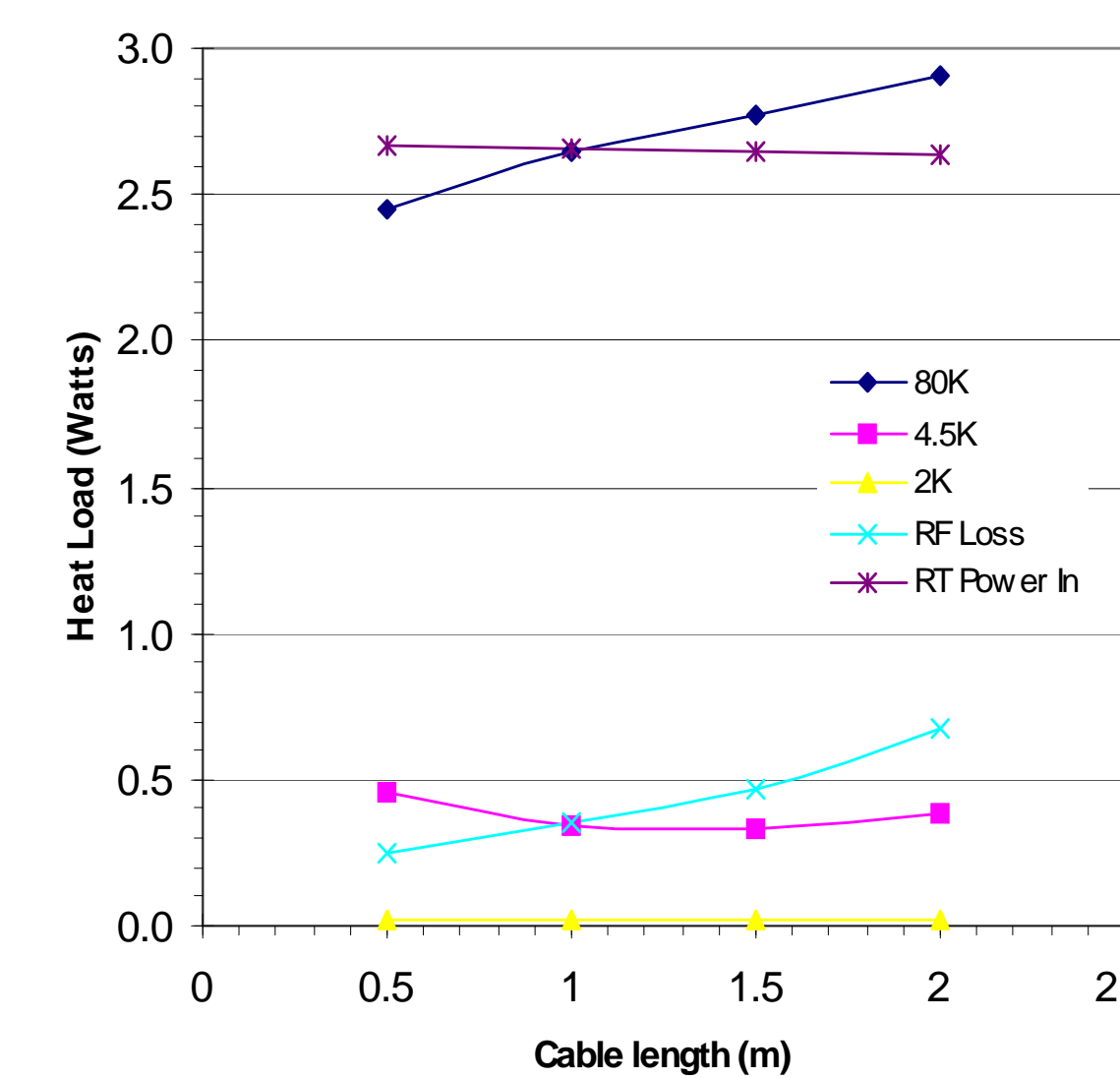

Figure 10: Dynamic heat loads as a function of cable length at the different junctions (10W RF, large dia. cable).

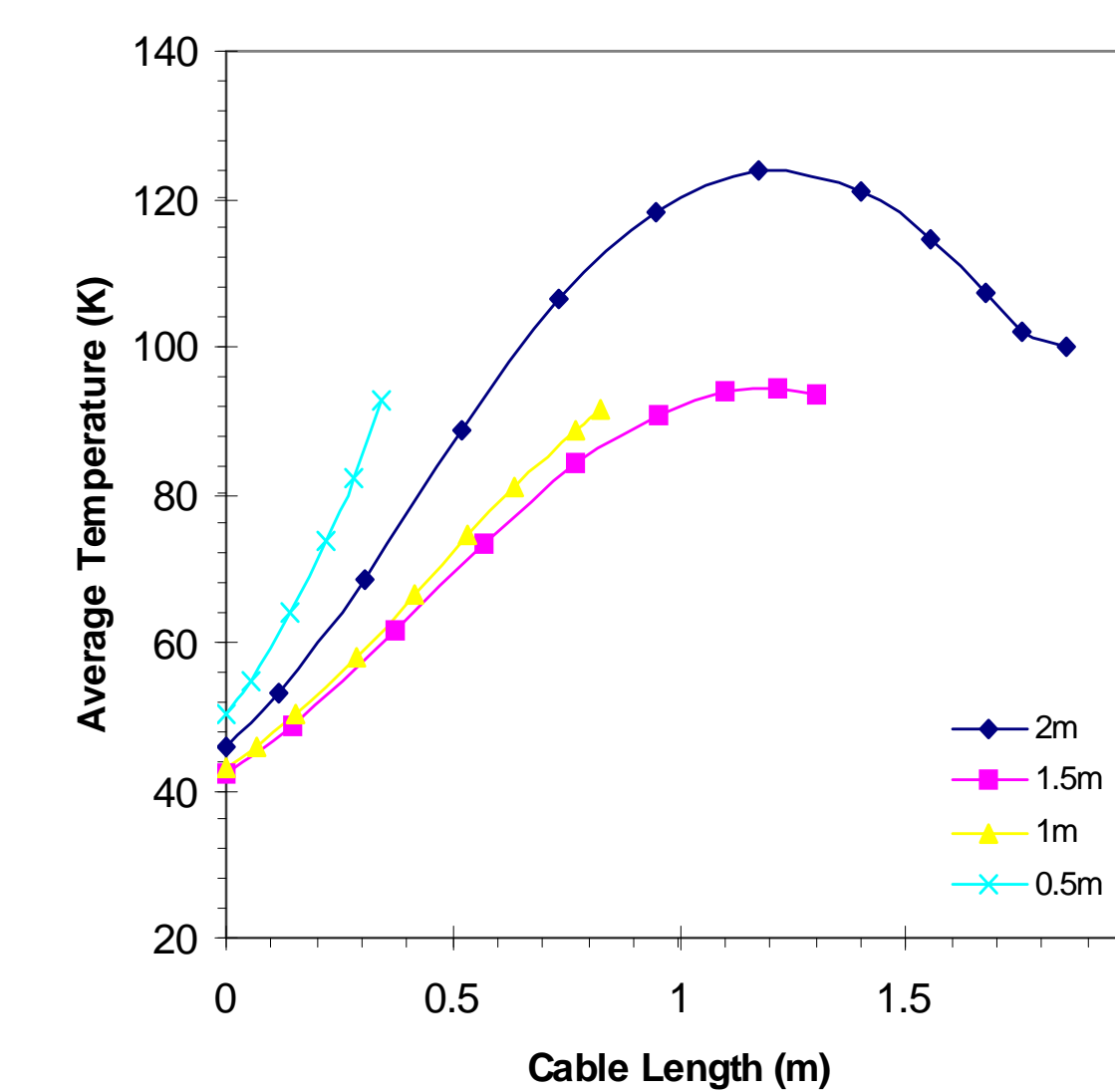

Figure 11: Dynamic temperature distribution in cable for different cable lengths up to 80K point (10W RF, large dia. cable).

Heat loads into the 2K surface averaged 18mW for all cases solved (including static and dynamic) and were independent of cable length and size since heat flow in the coupler was primarily into the 4.5K heat sink.

Fig.'s 10 and 11 show dynamic heat loads and cable temperatures at a higher test power of 10W using the large dia. cable. The temperature profile in the cable doesn't change much till about 1.5m length; at 2m the temperature starts to rise toward the cable center (as with the small dia. case at 4W), and peaks at around 125K which is within acceptable limits. Going with the small dia. cable at 10W and 2m, however, a very high cable temperature of 1,370K is reached; at 1.5m the peak temperature reduces to 755K. Again, a big difference is seen with the small dia. cable going from 1.5m to 2m in length, thus length being a critical factor for this size cable.

The temperature distribution in the coupler itself remains quite uniform with little affect from changing the cable size and length or RF power. Fig.'s 12 and 13 show temperature contour plots for the coupler at two different RF power levels and cable sizes. Hottest regions are in the Inconel inner conductor and SS adapter tip where the coaxial cable connects. Because of the 4.5K heat sink and 2K Nb tube surface, the temperature drops rapidly in the rest of the coupler down to ~7K in the Cu antenna and Alumina dielectric, and ~2K in the flanges and Nb tube.

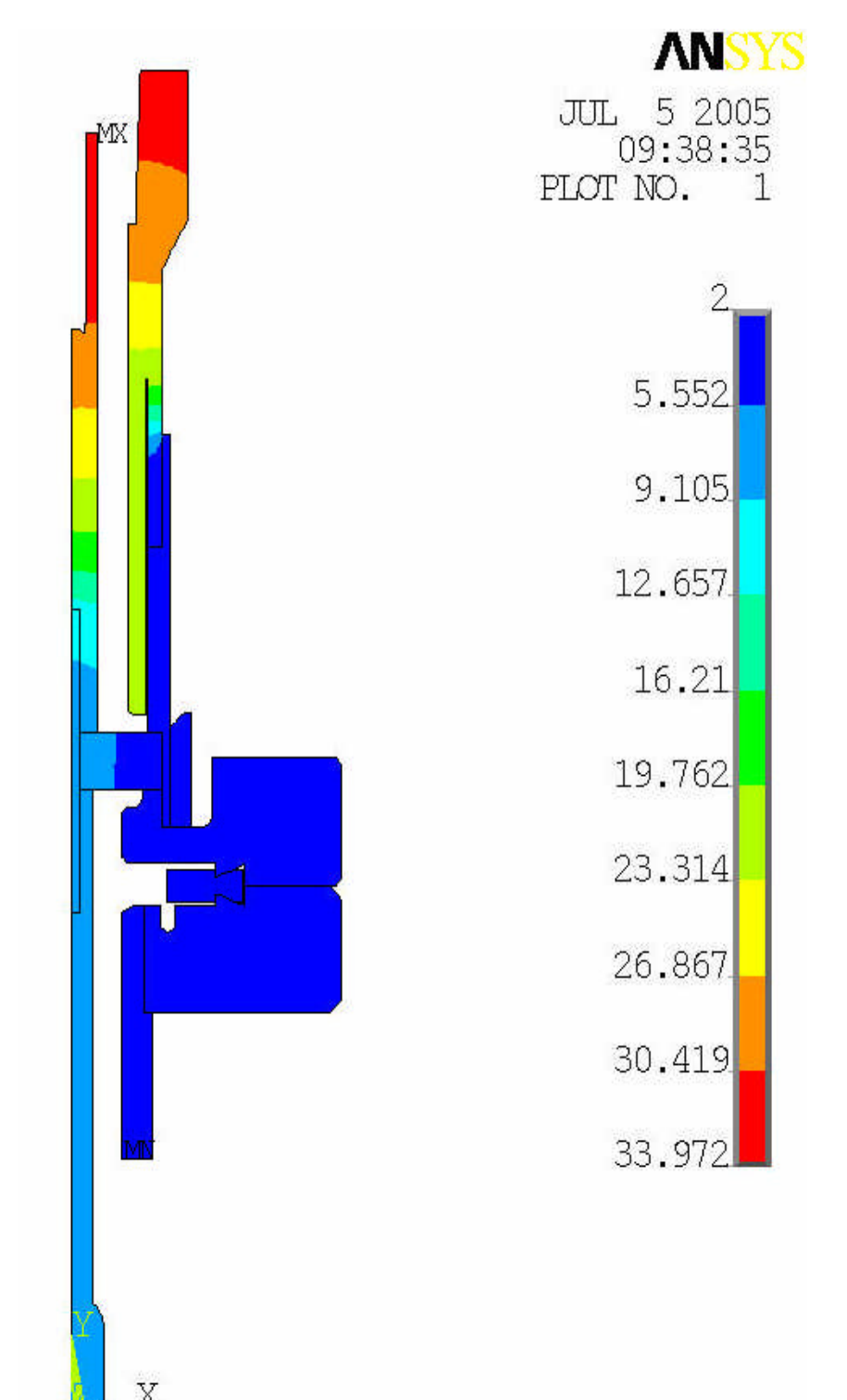

Figure 12: Dynamic temperature contour plots in coupler for 1.5m cable length (4W RF, small dia. cable).

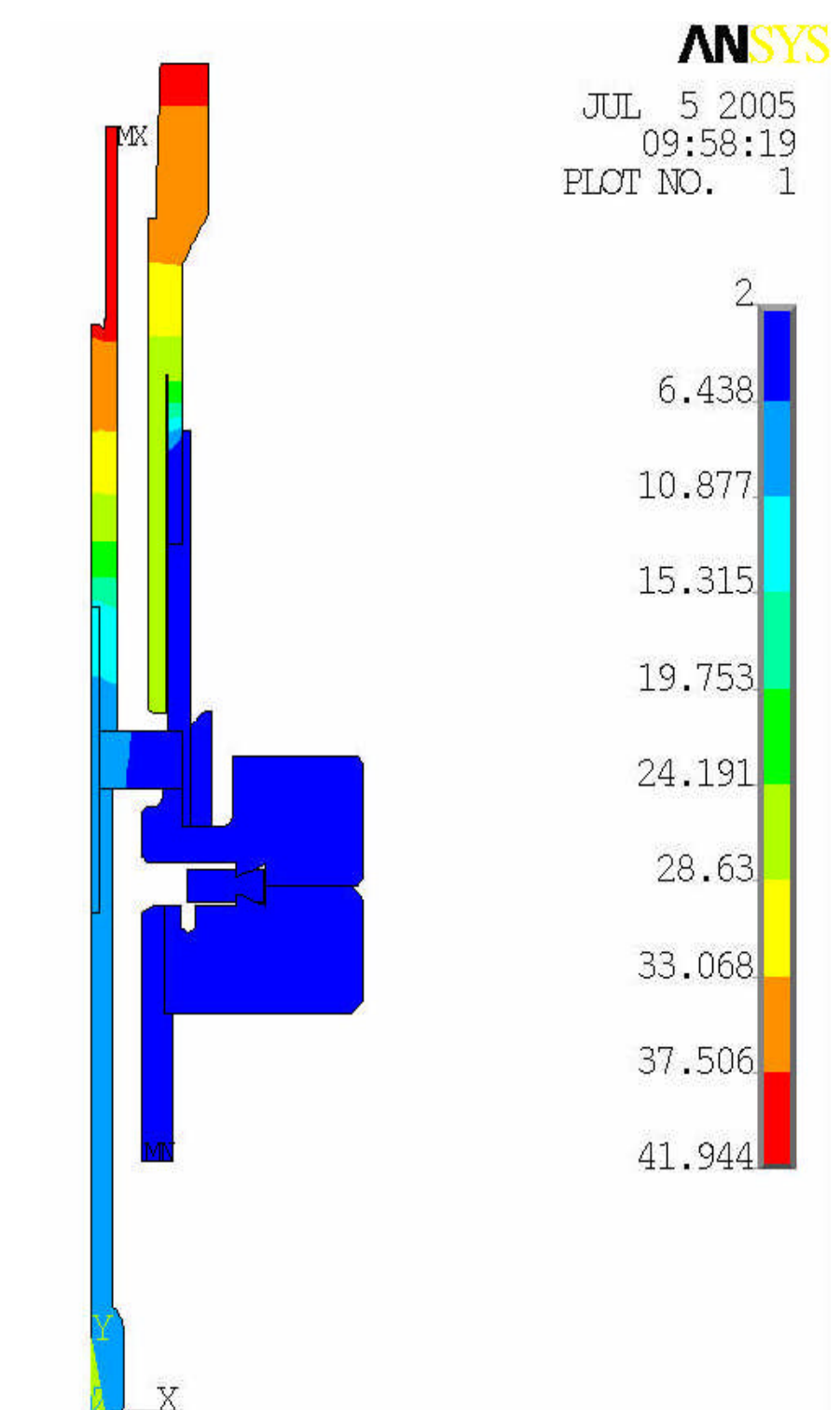

Figure 13: Dynamic temperature contour plots in coupler for 1.5m cable length (10W RF, medium dia. cable).

Heat flow into the coupler from RF losses and the outside (room temperature) is primarily into the 4.5K heat sink as seen earlier. By removing the 4.5K tie-in, this heat would redirect to the 2K surface (cavity end) which would be much more expensive from a cryogenics standpoint; and since it is a more 'restricted' heat path, temperatures in the cable and coupler will also be higher.

The 80K intercept actually draws heat in from the outside (~2.8W for large dia. cable; ~0.84W for small dia. cable) because of the large ΔT and short conductive distance, but helps keep cable temperatures low and thus reduce RF losses and heat loads into the 4.5K shield. By eliminating this intercept, heat loads into the 4.5K shield will more than double. Moving the location of the 80K intercept further inwards might help reduce the overall heat loads and temperatures.

CONCLUSION

Results from the FEA indicate that to minimize heat loads into the cryogenic system and keep temperatures to within acceptable limits, the correct combination of cable size and length should be chosen that will also protect the cable from thermal meltdown in the case of testing at higher power levels. Also, the tie-in to the 4.5K shield is crucial in minimizing heat loads to the 2K, which averaged 18mW for this analysis.

The small diameter cable was found to be the best choice for cable lengths up to 1.5m and 4W average RF power. For longer cable lengths and higher anticipated power (up to 10W), the larger diameter cable is recommended to keep temperatures in the cable within acceptable limits.