

# STORAGE RING MEASUREMENT of the PROTON ELECTRIC DIPOLE MOMENT

Richard Talman  
Laboratory of Elementary-Particle Physics  
Cornell University

LEPP Journal Club, 26 October, 2012

## Contents

1	Theoretical Motivation for EDM Measurement	6
2	Having both MDM and EDM Violates both P and T Symmetries	8
3	Estimate of EDM-Induced Spin Precession	9
4	EDM Measurement Challenges	10
5	All-Electric (Proton) Storage Ring Design	11
6	All-Purpose Ring for Protons, Deuterons, etc., at Juelich, Germany	17
7	Resonant Polarimetry	20
8	Beam-Beam Polarimetry	29
9	BNL and FNAL Proton EDM Options	31
10	Commissioning Scenario	32

- Electric dipole moment (EDM) measurements may help to answer the question “Why is there more matter than anti-matter in the present universe?”
- For a charged baryon like the proton such a measurement is thinkable only in a storage ring in which a bunch of protons is stored for more than a few minutes, with polarization “frozen” (relative to the beam velocity) and with polarization not attenuated by decoherence.
- After describing the salient issues for the experiment, the lecture will discuss novel polarimetry methods that are expected to make the experiment practical and which LEPP is ideally positioned to provide.

- It is important to obtain the EDM's for both proton and neutron. One has to extract the neutron value using deuteron, helium3, or some other charged complex nucleus.
- But deuterons and helium3 need both electric and magnetic bending to freeze the spins. This complicates the storage ring design. The COSY lab in Juelich, Germany, is studying this possibility.

- Magnetic resonance is proposed for monitoring the beam polarization. The method is passive and non-destructive.
- The magnetic resonance polarimeter measures longitudinal polarization. It could be called an NMR or MRI polarimeter with the spins “resonating” at the ring revolution frequency (about 1 MHz).
- The main lattice feature required for resonant polarimetry is a few “mini-beta” sections.
- These mini-beta sections (plus the counter-circulating beams needed to cancel systematic errors) also make “beam-beam polarimetry” based on elastic proton-proton scattering practical. This measures transverse polarization.

## 1 Theoretical Motivation for EDM Measurement

- Distant past: theoretical speculations concerning matter/anti-matter imbalance by Sakharov, emphasizing CP violation, motivated a (null) neutron EDM search by Ramsay.
- 1981: Ellis et al.: “we deduce an order-of-magnitude lower bound on the neutron electric dipole moment:  $d_n \approx 3 \times 10^{-28}$  e cm.”
- 1992: Weinberg, conference summary: “...electric dipole measurements seem to me to offer one of the most exciting possibilities for progress in particle physics.”
- 2007: Nuclear Science Advisory Committee (NSAC) emphasized the importance of electric dipole moment (EDM) measurements for addressing the matter/anti-matter imbalance.

- Recent insight: stored for many minutes in a storage ring, proton EDM's should be more accurately measurable than neutron EDM's.
- 2011: Arkani-Hamed, at a Conference on Fundamental Physics, identified EDM's (along with quark and lepton flavor physics) as the areas of greatest promise.
- CP violating terms in the standard model give a proton EDM somewhat less than  $10^{-29}$  e-cm, somewhat smaller than can be measured in practice.
- But the CP violating terms in the standard model also seem to be far too small to account for the matter/antimatter imbalance in the universe.
- This talk discusses experimental practicalities of measuring the proton EDM, anticipating a value of, perhaps,  $10^{-28} \pm 10\%$  e-cm.

## 2 Having both MDM and EDM Violates both P and T Symmetries

- Magnetic dipole (MD) is a pseudo-vector aligned with some axis.
- Electric dipole (ED) is a vector aligned with the same axis.
- The ED and MD of the same particle cannot be said to be “parallel” without violating parity P—viewed in a mirror ED and MD would be anti-parallel.
- It would also violate time reversal T—run backwards, MD would reverse, ED would not.
- Certainly a proton has an MDM. For it to also have an EDM implies violation of T symmetry.
- With CPT symmetry assumed, T violation also implies CP violation, which was one of Sakharov’s necessary conditions for the cosmic evolution to unbalanced fractions of matter and anti-matter.



### 3 Estimate of EDM-Induced Spin Precession

- Optimistically an EDM of  $10^{-29}$  e-cm can be persuasively distinguished from zero in one year of running. In SI units

$$d_{\text{nom}} = 10^{-29} \cdot (1.602 \times 10^{-19}) \cdot (0.01) = (1.602 \times 10^{-50}) [\text{SI}]. \quad (1)$$

- Ratio to nuclear magneton:

$$\frac{d_{\text{nom}}}{\mu_B} = \frac{(1.602 \times 10^{-50})}{(5.05 \times 10^{-27})} = 3.127 \times 10^{-24}, \text{ S.I. units} \quad (2)$$

- This ratio is not dimensionless. The missing factor is  $E/B$ . For our configurations, in SI units, this ratio is typically  $10^7/0.1 \approx 10^8$  m/s.
- After multiplying by this factor, the relative-effectiveness ratio of EDM to MDM has a numerical value of about  $3 \times 10^{-16}$ .

## 4 EDM Measurement Challenges

- **Relative precession task:** Distinguish EDM-induced vertical precession from spurious, wrong-plane, MDM-induced, precession. For comparable deflecting fields the MDM torque exceeds the (nominal,  $10^{-29}$  e-cm) EDM torque in the ratio  $3 \times 10^{-16}$ .
- **Absolute precession task:** For a pure Dirac particle in a magnetic field the precession is  $2\pi$  per turn. At one microsecond per turn, this is of order  $10^7$  radians/s.
- Applying the  $3 \times 10^{-16}$  ratio, we therefore plan to measure a “nominal” EDM-induced precession of order  $10^{-9}$  r/s.
- For EDM of  $10^{-28}$  e-cm this is about 1 mr/day.

## 5 All-Electric (Proton) Storage Ring Design

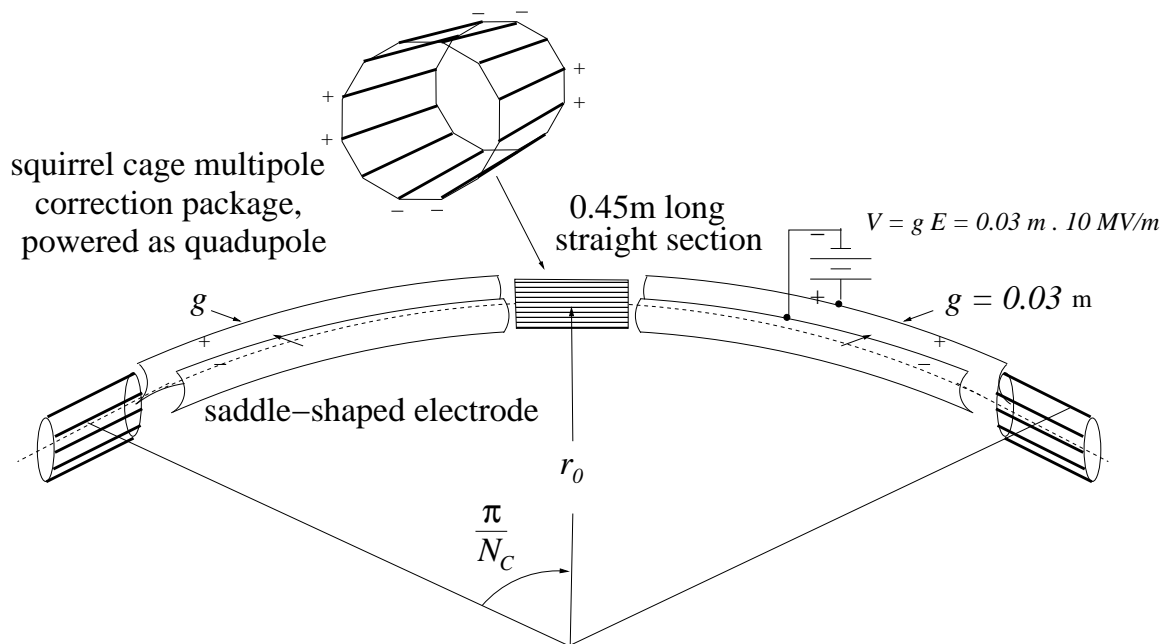

Figure 1: Sketch of one cell of baseline proton EDM lattice. There are **counter-circulating proton beams**.

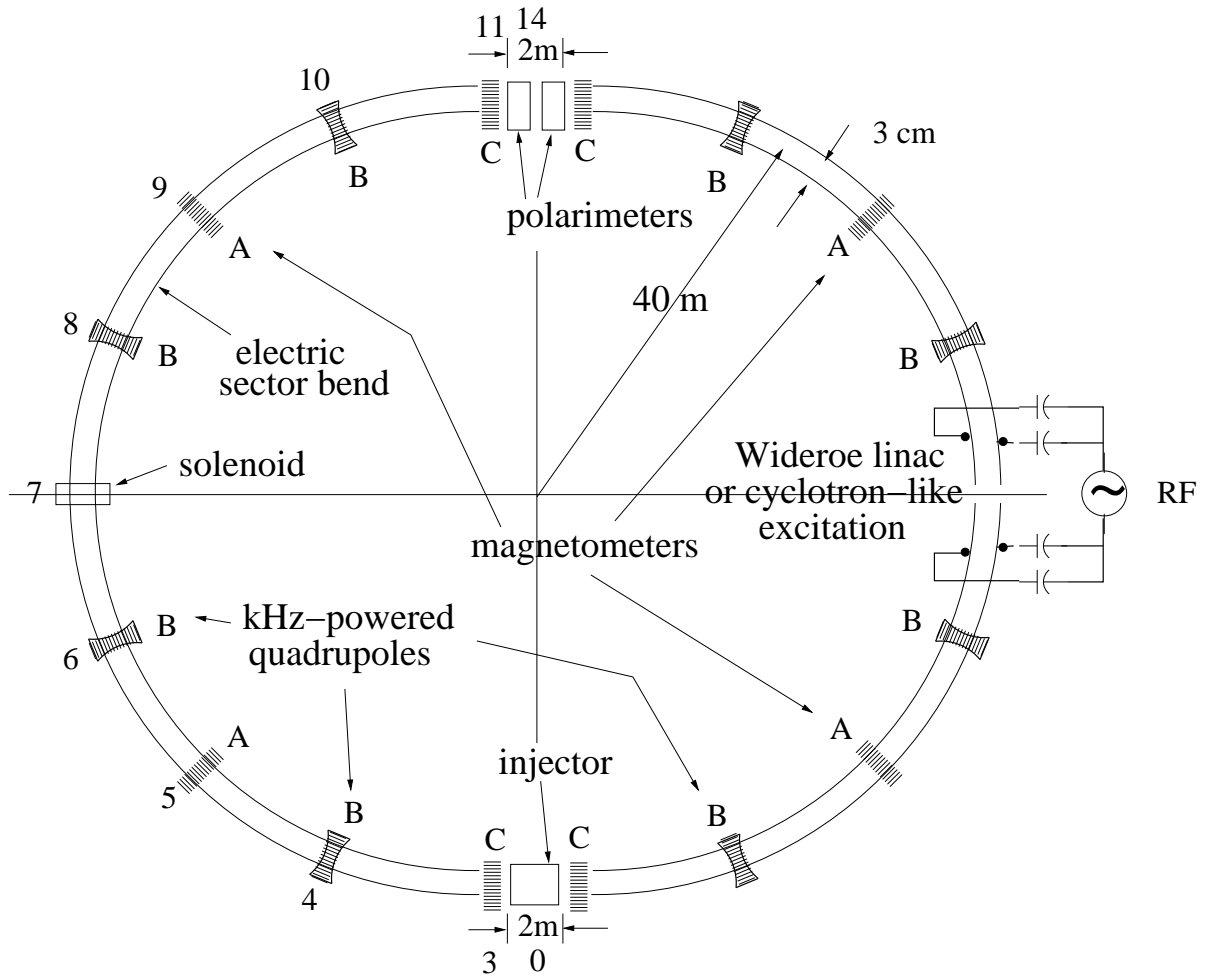

Figure 2: A (very) weak focusing, **minimized drift length**, all-electric lattice (BNL proposal) for measuring the electric dipole moment of the proton.

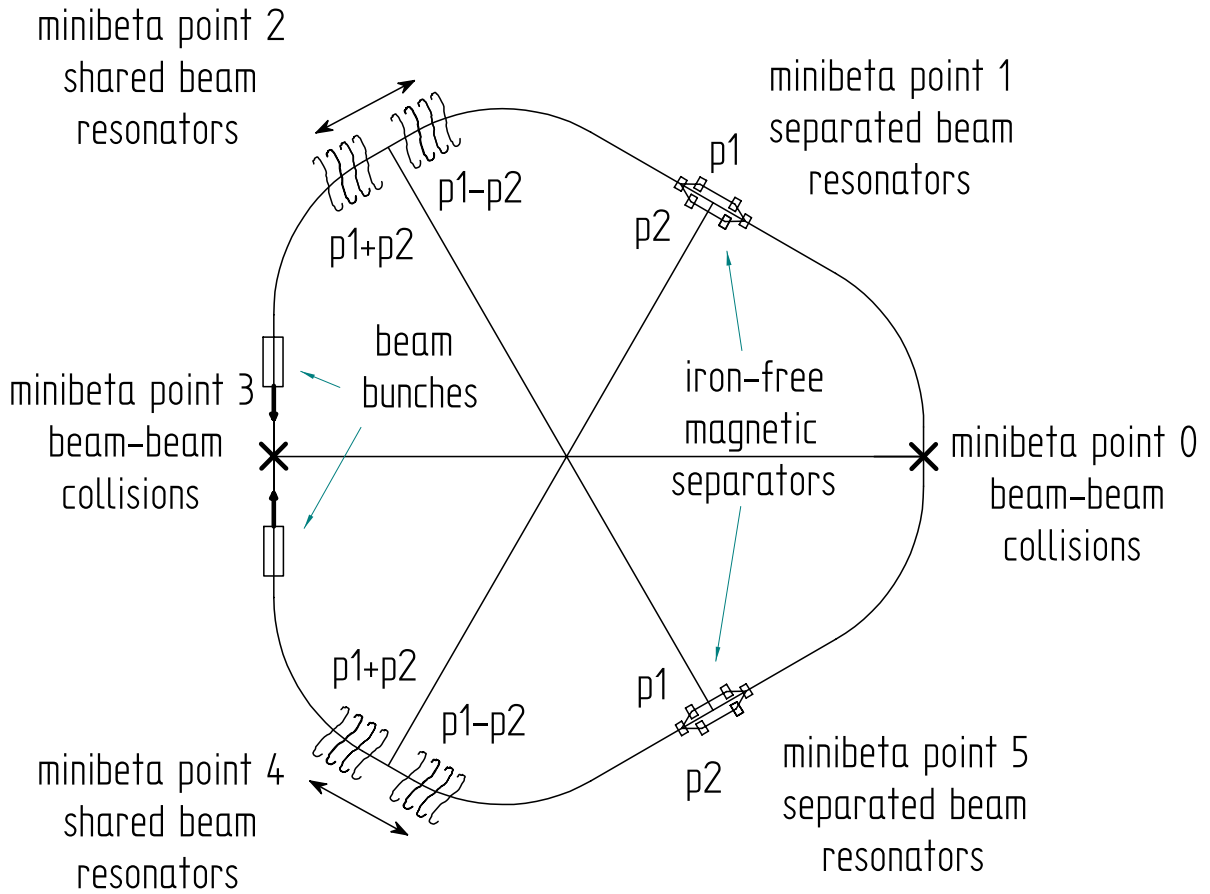

Figure 3: “Multi-Mini-beta” ring in the FNAL accumulator ring tunnel. There are polarimeters at each of the six mini-beta sections, at the centers of both long and short straight section.

## 5.1 Lattice and Mini-Beta Design

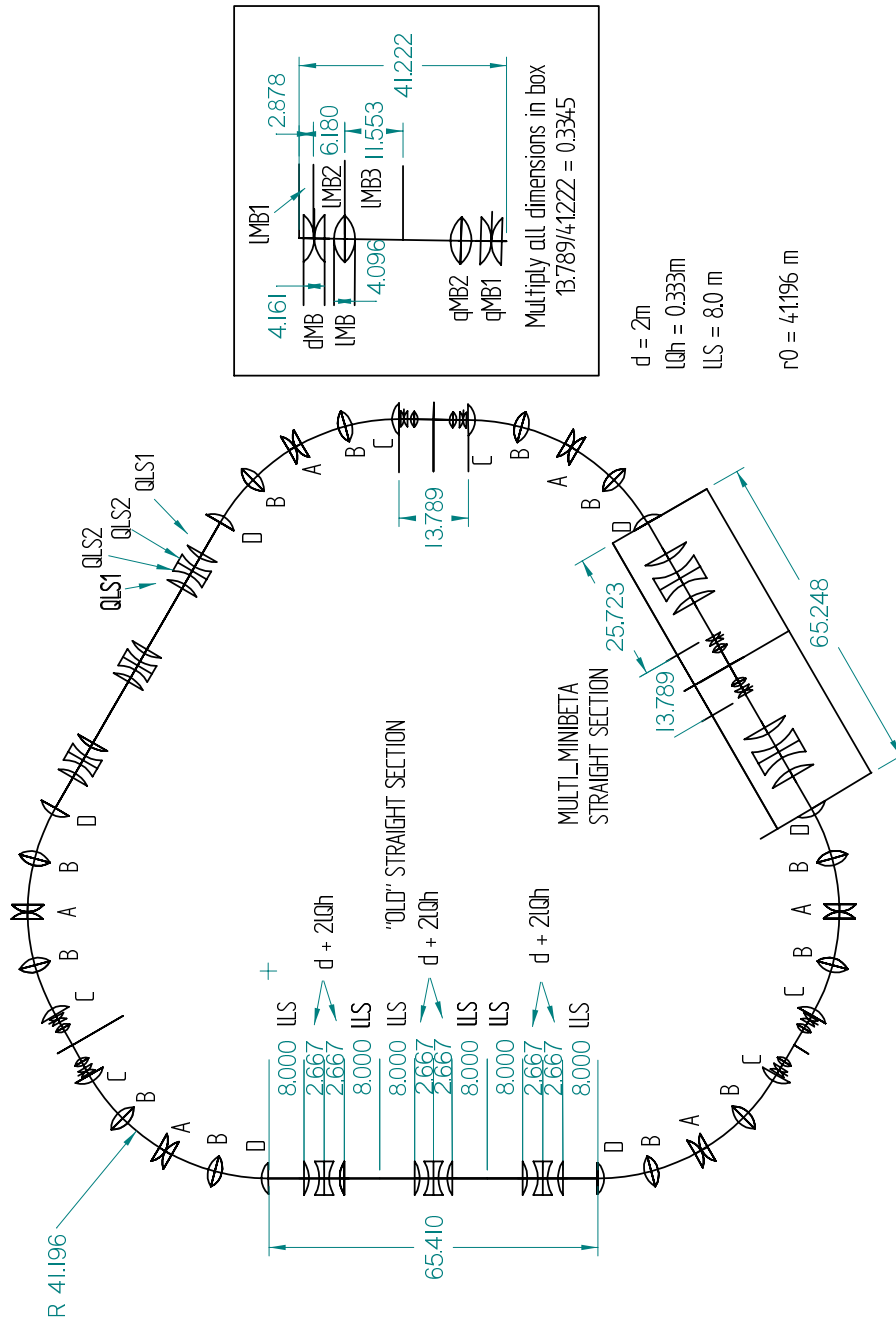

Figure 4: The “Multi-Mini-beta” proton EDM ring in the Fermilab Accumulator Ring tunnel and the ring. There is a mini-beta section at the center of each straight section

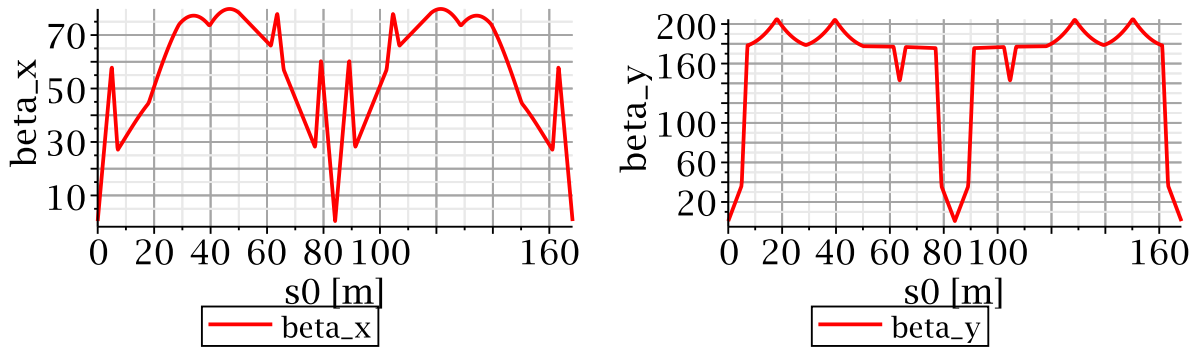

Figure 5: Plots of lattice functions for (one third of) the multi-mini-beta lattice. Vertical optics have been more carefully matched than horizontal.

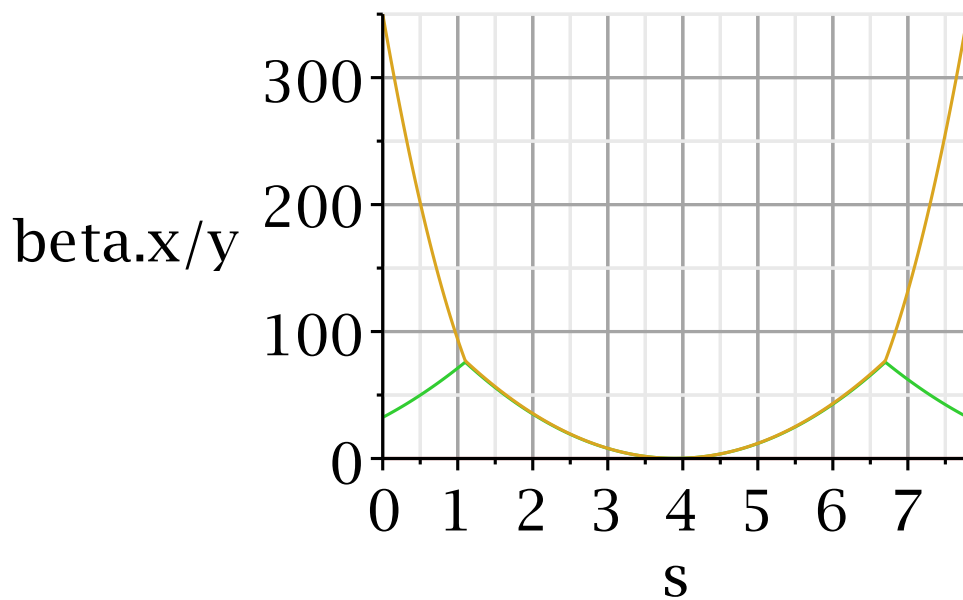

Figure 6: Beta function dependence for the six mini-beta sections. At the minima  $\beta_x^* = 0.311$  m and  $\beta_y^* = 0.718$  m. Though favorable for beam-beam luminosity, these values are unnecessarily small for resonant polarimetry.

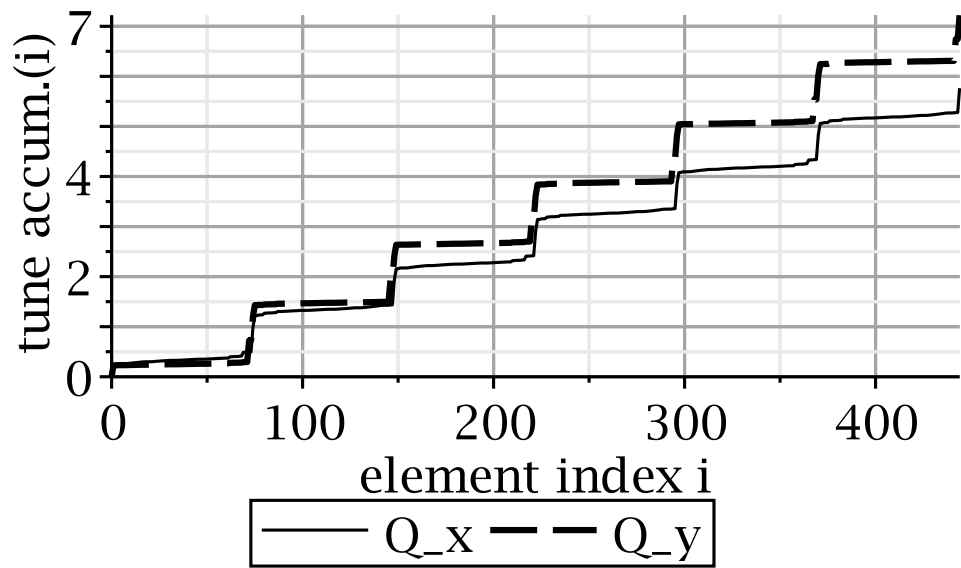

Figure 7: Advance of horizontal tune  $Q_x(i)$  and vertical tune  $Q_y(i)$  as the element index  $i$  advances along the central orbit. There is a tune advance of about 1 in each of the curves at each mini-beta section.



## 6 All-Purpose Ring for Protons, Deuterons, etc., at Juelich, Germany

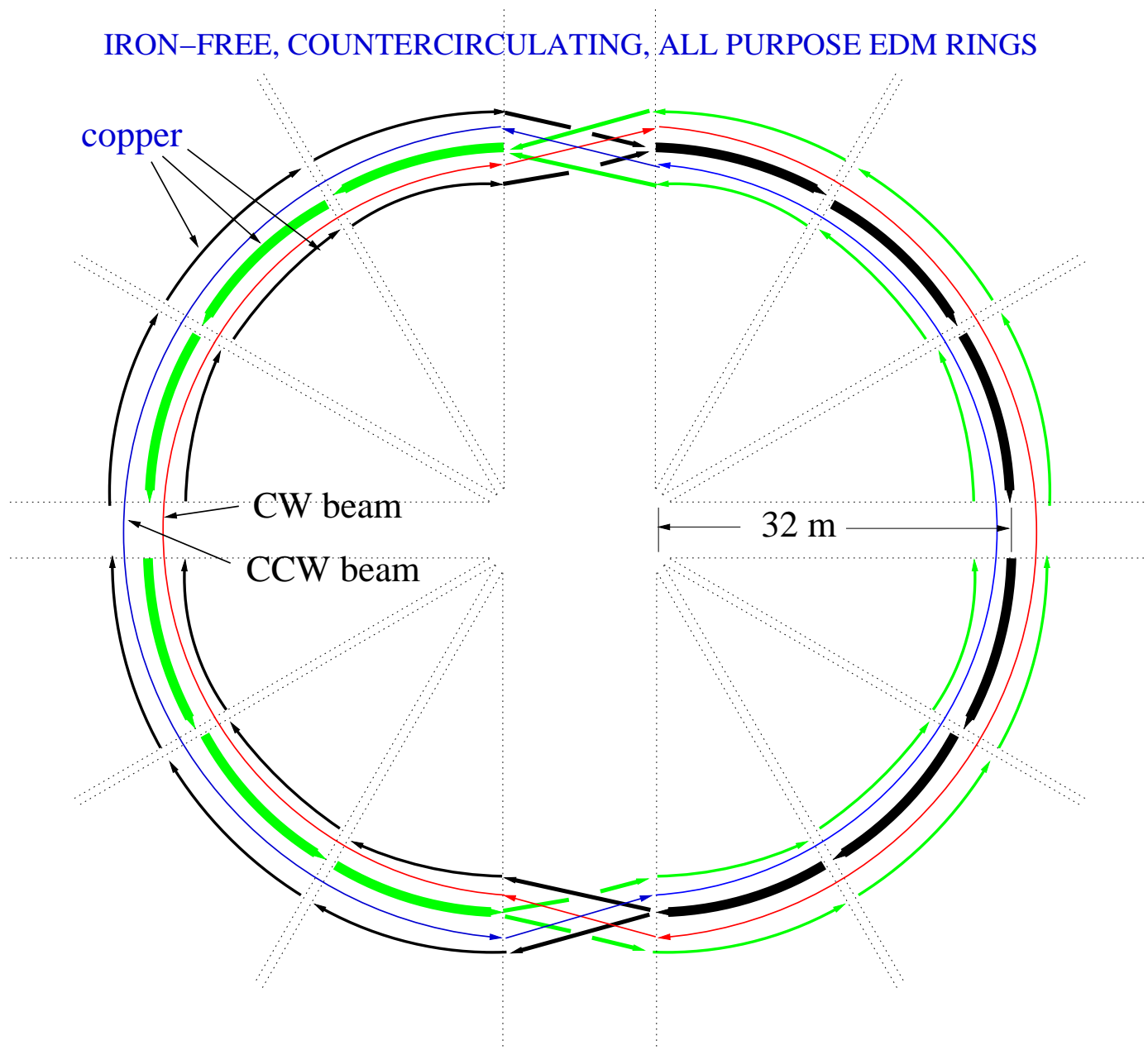

Figure 8: Current-only magnets for EDM measurements using counter-circulating beams with electric and/or magnetic deflection.

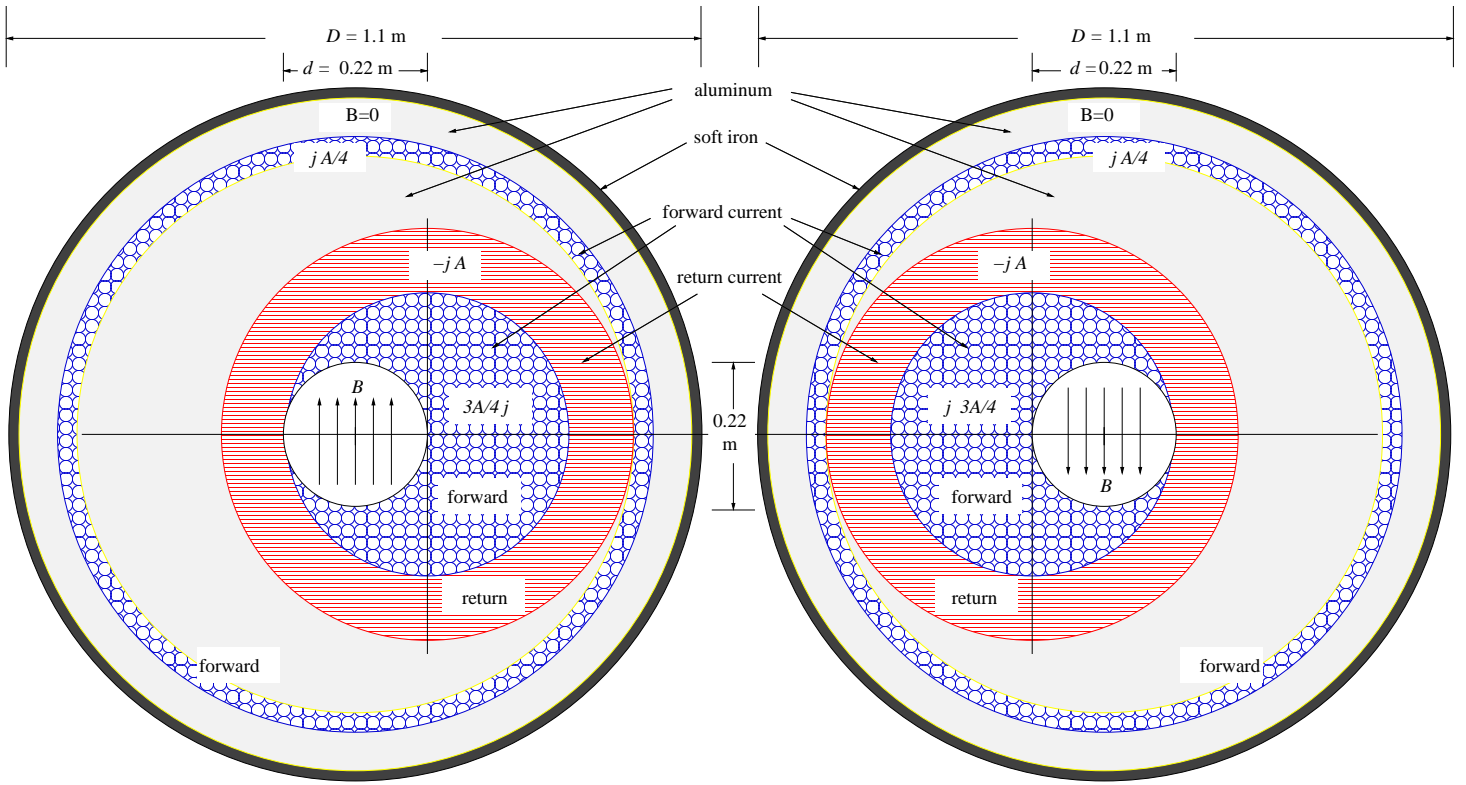

Figure 9: Side-by-side, uniform field bending magnets with the equal, but opposite signs, needed to steer CW and CCW beams of same-sign particles. Electrodes are not shown.

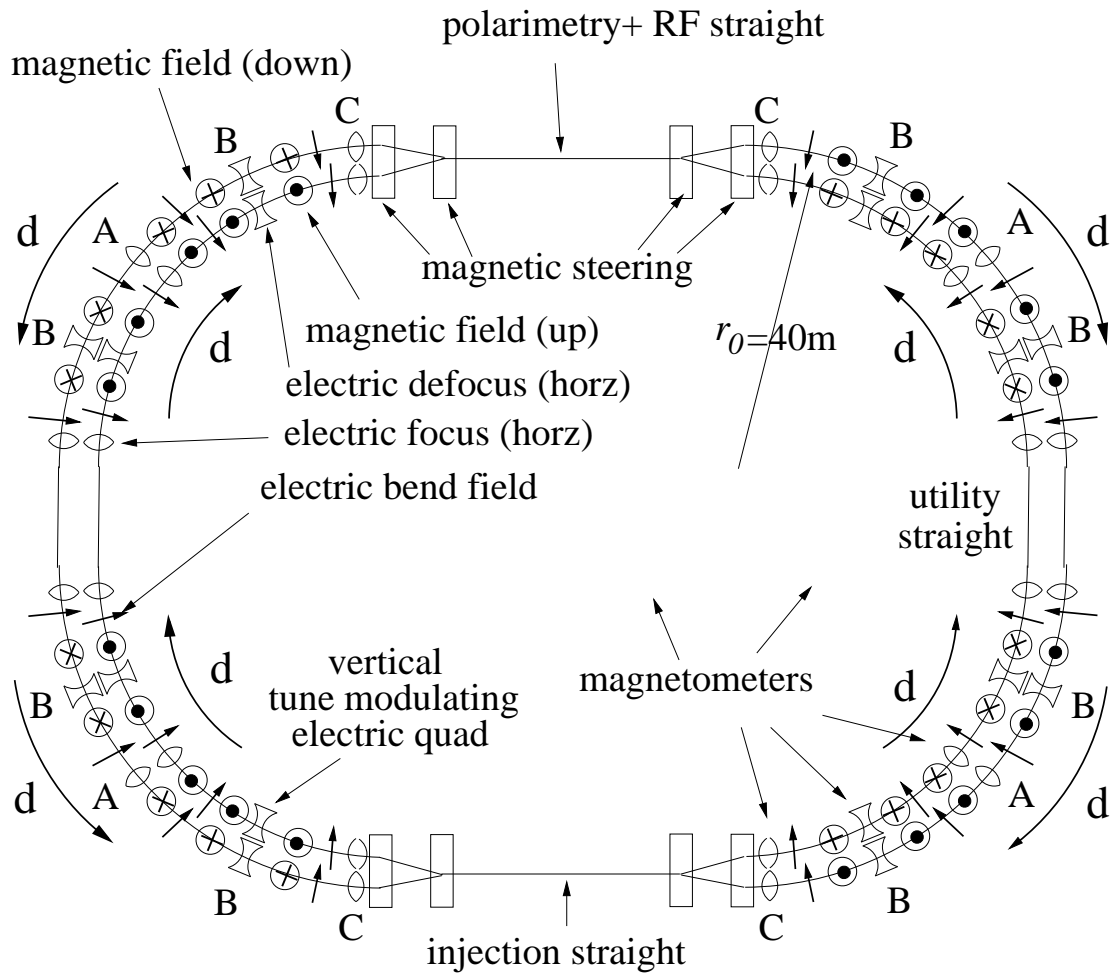

Figure 10: "All-In-One" lattice for measuring EDM's of protons, deuterons, and helions.

## 7 Resonant Polarimetry

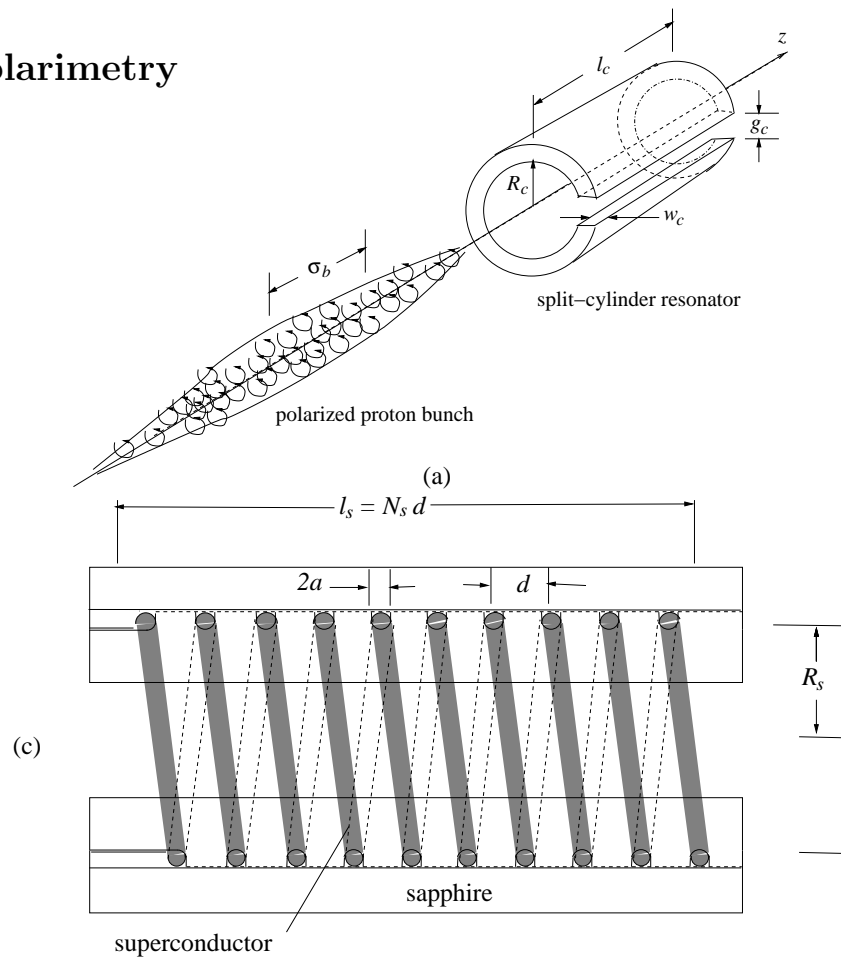

Figure 11: (a) Perspective view of the polarimeter. Dimensions are defined for the polarized proton bunch and the superconducting split-cylinder resonator. The resonator gap, shown as vacuum in the figure, may actually be filled by a low loss sapphire spacer. (c) A 30 turn solenoid gives 30 times greater signal and (estimated) signal to (thermal) noise ration comparable with the one turn solenoid.

Table 1: PARAMETERS OF ONE TURN SOLENOID

parameter name	parameter symbol	formula	unit	value
length	$l_c$		m	0.5
radius	$R_c$		cm	1
gap/dielec.const.	$g_c/\epsilon_r$		micron	1
thickness	$w_c$		mm	5
capacity	$C_c$	$\epsilon_0 \frac{w_c l_c}{g_c/\epsilon_r}$	nF	22.1
inductance	$L_c$	$\mu_0 \frac{\pi R_c^2}{l_c}$	nH	0.790
resonant freq.	$f_c$	$\frac{c}{2\pi^{3/2} R_c} \sqrt{\frac{g_c/\epsilon_r}{w_c}}$	MHz	38.1
quality factor	$Q_c$			$10^{10}$
eff. resist.	$R_{\text{eff}}$	$\frac{\omega_c L_c}{Q_c}$	ohm	$1.89 \times 10^{-11}$
rev. freq.	$f_0$	$v/C_l$	MHz	0.355
res. harm. number	$h_c$	$f_c/f_0$		107
RMS bunch length	$\sigma_b$	$\sigma_b$	m	1.2
“natural” bunch freq.	$f_b$	$\frac{v}{4\sigma_b}$	Mhz	37.5

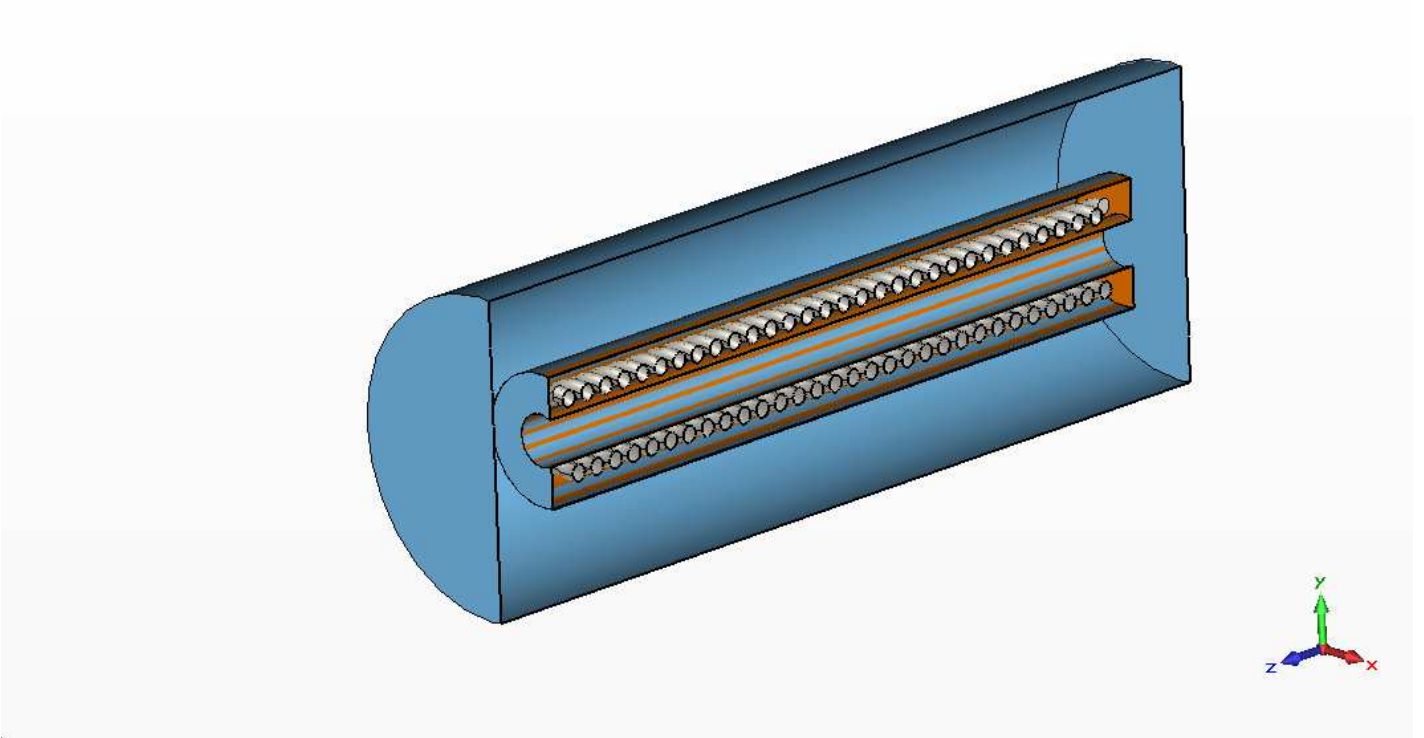

Figure 12: Model of resonator by Valery Shemelin using Microwave Studio

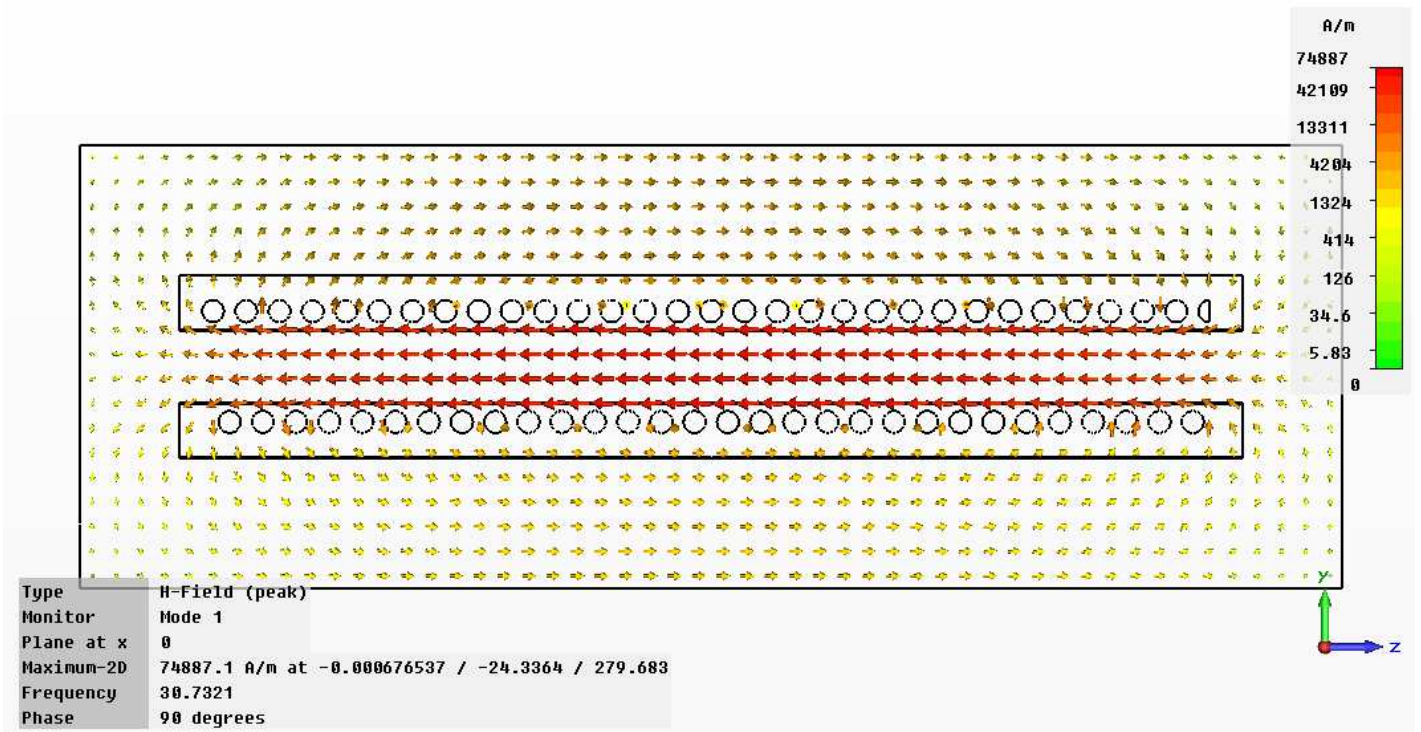

Figure 13: Vector plot of magnetic fields in resonator.

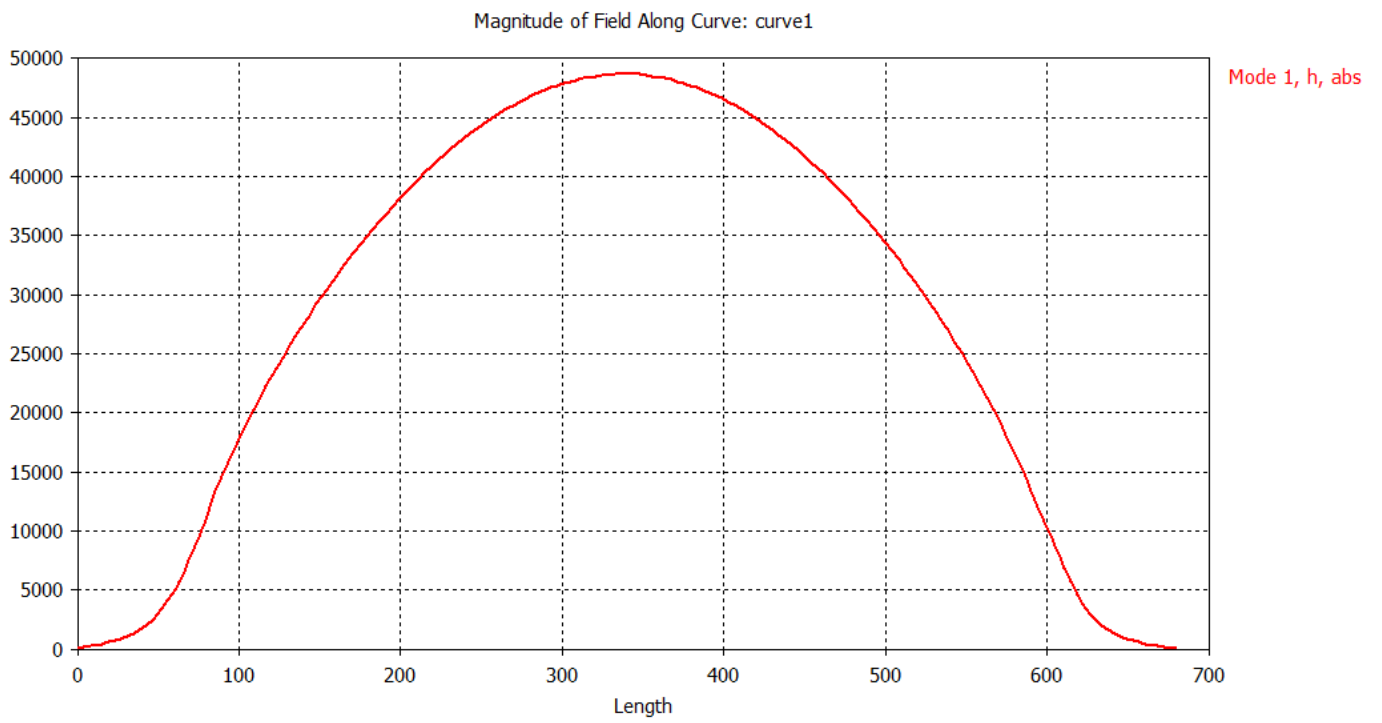

Figure 14: Graph of magnetic field on resonator axis.



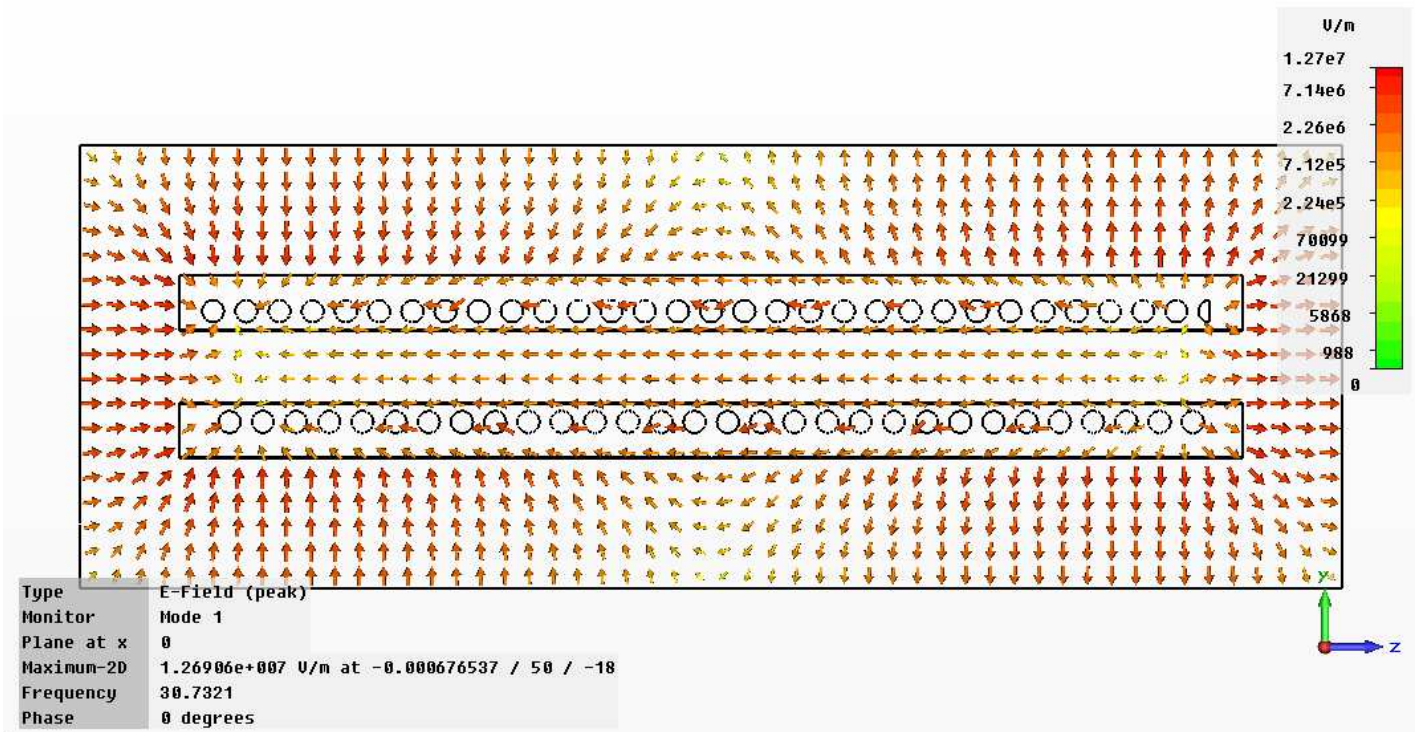

Figure 15: Vector plot of electric fields in resonator.

## 7.1 $\mathcal{EMF}$ Induced in Loop Threaded by a Polarized Proton Bunch

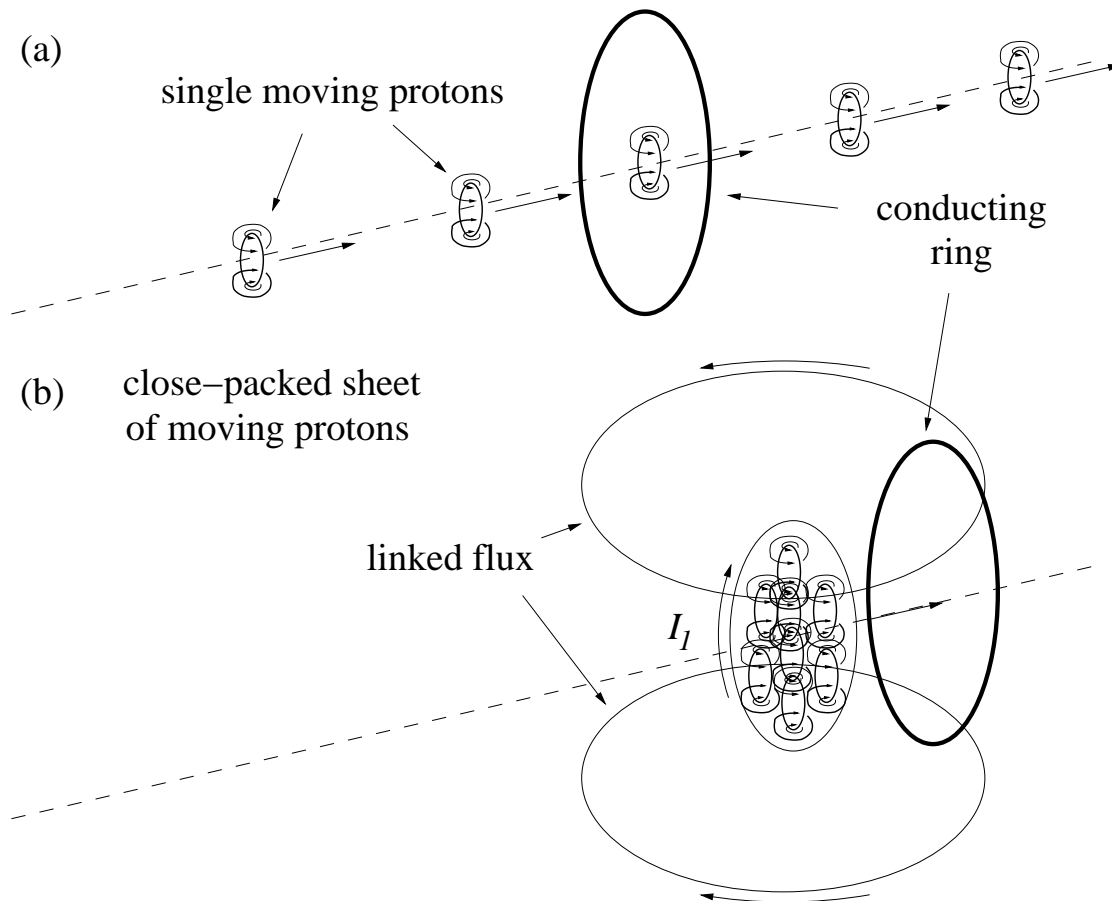

Figure 16: Protons passing through a conducting ring. The little ellipses represent proton current loops. Magnetic flux lines are indicated by little circles. In (a) there are single protons, each of radius  $R_1$ . In (b) there are  $N_p$  protons in a closely-packed protons in a circular sheet of radius  $\sqrt{N_p}R_1$ .

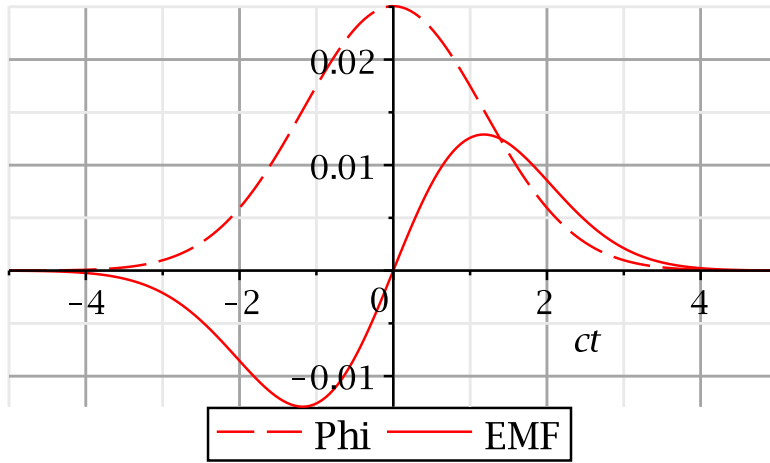

Figure 17: Plots of flux  $\Phi_m(R_c, \sigma_b, ct)$  and voltage  $V(ct)$  for  $R_c = 0.01$  m and  $\sigma_b = 1.0$  m. The absolute scale is arbitrary. The relative scale assumes  $v/c = 0.6$ . With  $ct$  in meters, the optimal response to such a bipolar pulse would have period  $T_{\text{res}} = 4(ct)_{\text{max}}[m]/c \approx 5/c = 16.67$  ns for a frequency  $f_{\text{res}} = 60$  MHz.

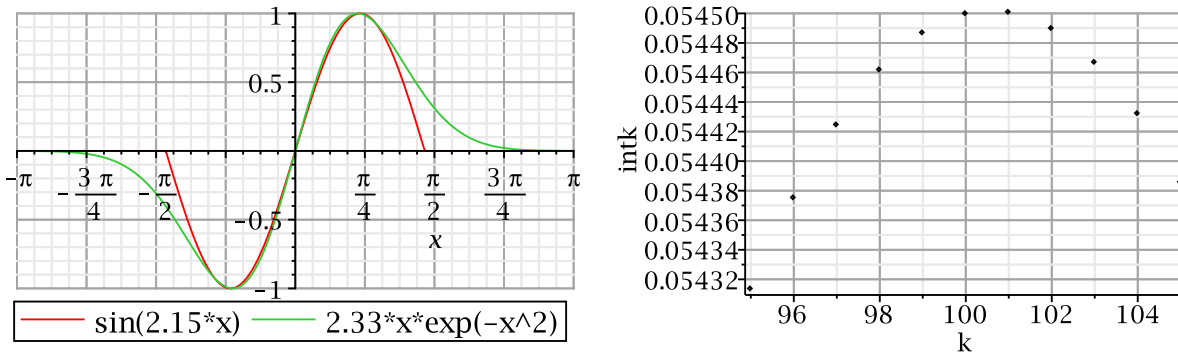

Figure 18: The left figure shows a “tolerably good” cut-off sinusoidal fit superimposed (for approximate Fourier analysis). The right hand plot shows Fourier coefficients in the Fourier expansion of the resonator excitation. The frequency spacings are equal to the revolution frequency, which here is taken to be 1 MHz, The arbitrarily-selected bunch length corresponds to a frequency of 100 MHz plus  $20.1/(2\pi)$ .

## 7.2 Signal to Noise Ratio

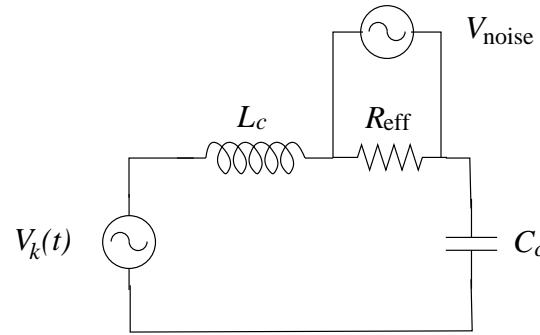

Figure 19: Circuit model for the polarimeter resonator excited by the polarized beam magnetization.

## 8 Beam-Beam Polarimetry



BOTH FAIL



BOTH SUCCEED



Figure 20: Two “pitchers” are throwing (special) balls toward each other, trying to make them “curve” in the natural direction of curve balls in baseball. Any success they have depends on collisions with balls coming in the opposite direction (and treated as viscous medium).

## 8.1 Polarimetry Counting Statistics

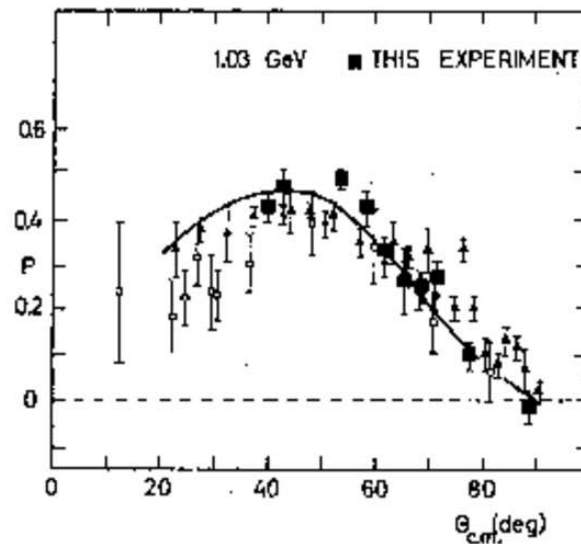

FIG. 8. Polarization in  $p$ - $p$  scattering at 1.03 GeV. Open squares represent data from Ref. 15; shaded triangles, data from Ref. 3.

Figure 21:  $p$ - $p$  polarization measurements of Neil, Longo et al. at the effective lab energy  $K_{lab.} = 1.03$  GeV, interpreted as **left-right asymmetry of polarized protons on unpolarized target**.

- Left-right scattering asymmetry from unpolarized target is about  $1/3$ , say 200 to left, 100 to right.
- (About) 150 of these scatters have to be LR symmetric (because target is unpolarized).
- For perfectly polarized target take 75 from each of the above, leaving 125 to left, 25 to right; asymmetry is  $100/150 = 2/3$ .

## 9 BNL and FNAL Proton EDM Options

Table 2: Parameters for various storage ring options. All parameters (except in the last row) are specific to rings and independent of polarimetry and RF cavity parameters. Bold face entries correspond approximately with numerical examples in the text.

polarimetry			BNL, carbon		FNAL, resonant	
			intensity		intensity	
quantity	symbol	unit	low	high	low	high
circumference	$\mathcal{C}_0$	m	263.4	263.4	<b>506.7</b>	506.7
period	$T_0$	$\mu\text{s}$	1.46	1.46	<b>2.82</b>	2.82
rev. freq.	$f_0$	MHz	0.683	0.683	<b>0.355</b>	0.355
protons per bunch	$N_p$		2.0e8	1.0e9	<b>1.0e10</b>	1.0e11
bunches in each ring	$N_B$		24	24	<b>1</b>	1
bunch length	$\sigma_z$	m	0.1	0.2	<b>1.2/4.8</b>	12.0
beta functions at IP's	$\beta_x^*/\beta_y^*$	m	28/240	28/240	<b>0.31/0.72</b>	0.31/0.72
beta function maxima	$\beta_x^{\text{max}}/\beta_y^{\text{max}}$	m	28/240	28/240	<b>80/200</b>	80/200
tunes	$Q_x/Q_y$		1.30/0.20	1.30/0.20	<b>5.76/7.20</b>	5.76/7.20
beam-beam tune shift	$\xi$		-1.6e-3	-0.8e-2	<b>-0.0033</b>	-0.033
Laslett tune shift	$\Delta Q_{\text{Laslett}}$		0.036	0.090	<b>0.046</b>	0.185
p-p collision rate per IP		1/s			<b>19/9.5</b>	190/95
resonant S/N	$V_k/\sqrt{V^2}$				<b>70.6</b>	706

## 10 Commissioning Scenario

- (Precisely-) Fixed Frequency Feed-Forward Storage Ring Operation (as Contrasted with Polarimeter-RF Feedback)
- RF frequency is set to its nominal phase and amplitude, close to matching  $T_0$  (which is only approximately known).  $f_{\text{rf}}$  is to be held perfectly fixed during any single run.
- Beam is injected from one of the injection lines; some is captured in RF buckets but soon spirals in or out and is lost.
- Electric field is adjusted to eliminate the spiraling. This setting is then further stabilized by FEEDBACK FROM RADIAL BEAM POSITION TO ELECTRIC FIELD.
- Captured beam is steered onto the design orbit with exquisite accuracy, say  $\pm 0.5 \times 10^{-4}$  m accuracy, using radial BPM's and radial kickers. At this point, from  $f_{\text{rf}}$  and known harmonic number,  $T_0$  is known to arbitrary accuracy and  $C_0$  is known to  $10^{-7}$  fractional accuracy.



- All parameters can then be adjusted to move the proton speed onto its magic value with  $\pm 10^{-7}$  fractional accuracy. In this state the polarization can be expected, typically, to precess through one full revolution roughly every  $10^7$  turns; that is, every 10 s.
- Using peripheral connection electronics, the resonant polarimeter frequency has meanwhile been tuned onto an appropriate harmonic of the RF frequency. Fully polarized beam is then injected. Especially with multiple polarimeters and multiple tries, this should give a hint of signal in the resonant polarimeters.
- From this point, using FEED-FORWARD FROM THE RESONANT POLARIMETER, the RF frequency is adusted onto the precise frozen spin frequency.

- As long as the beam polarization does not decay, since the relative tuning of RF and resonator is known to be approximately correct, one expects the resonator response to fade in and out in response to unpredictable drifts. In the absence of noise, with no drifts, one would OBSERVE BEATS IN THE RESONATOR RESPONSE, SHOWING THAT THE BEAM POLARIZATION IS ALMOST, BUT NOT PRECISELY, FROZEN.
- This situation would still not be satisfactory since any EDM effect would average to zero even if the total precession is only through  $2\pi$ . To have any hope of detecting an EDM signal the beams have to be perfectly frozen. With ZERO BEATS the EDM effect can accumulate indefinitely.
- This amounts to FRINGE-COUNTING, TIME-DOMAIN, INTERFEROMETRY.
- **BOTTOM LINE: THE ABSENCE OF “BEATS” or “FRINGES” IN (NON-VANISHING) RESONATOR RESPONSE PROVIDES PROOF-POSITIVE OF FROZEN SPIN PERMANENCE THROUGH THE WHOLE RUN.**

## 10.1 Readout

- Readout from the resonant polarimeter can resemble the readout from cryogenic, resonant KID (kinetic induction detectors), recently invented for measuring CMB (cosmic microwave background).
- KID can (in principle) detect (the energy deposited by) single soft photons in each of thousands of channels.
- We have to detect (the magnetic moment of)  $10^{10}$  protons in several units.

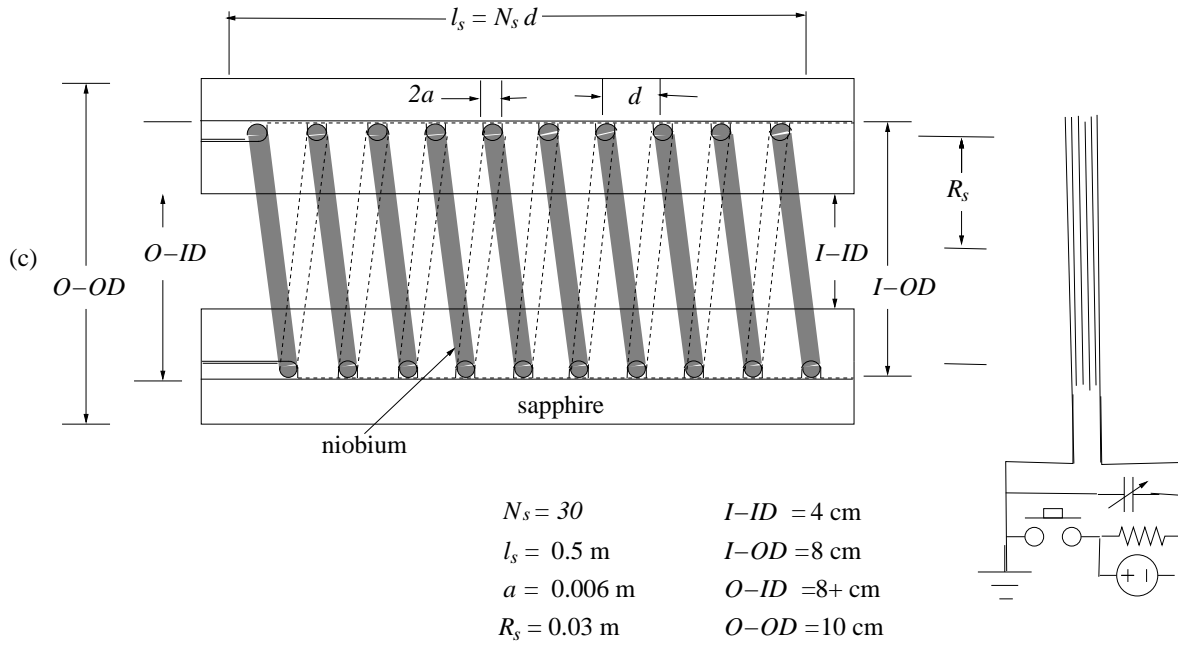

Figure 22: Possible resonator readout circuit.

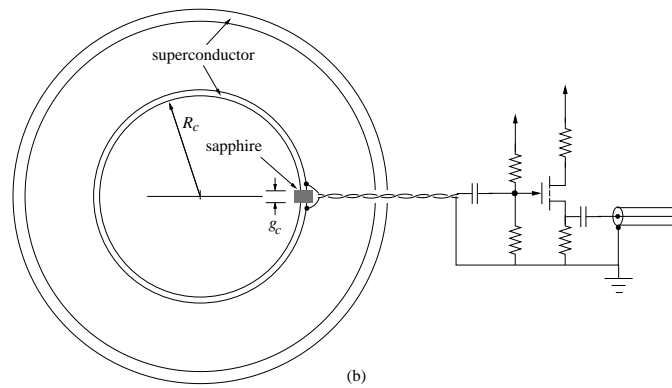

Figure 23: (b) End view of polarimeter and readout (copied from reference Huan et al. and using a low temperature pHEMT transistor such as Agilent type ATF-35143 in a source follower circuit).