



State-of-the-Art

Superconducting RF and RF Control

Matthias Liepe

Outline:

- **ERLs and SRF**
- **Challenges**
- **What we need, what we have, what is missing**
- **Outlook**





Cornell University

ERLs and SRF



ERL 2005

7 March 2005

Matthias Liepe
ERL 2005 Workshop

2

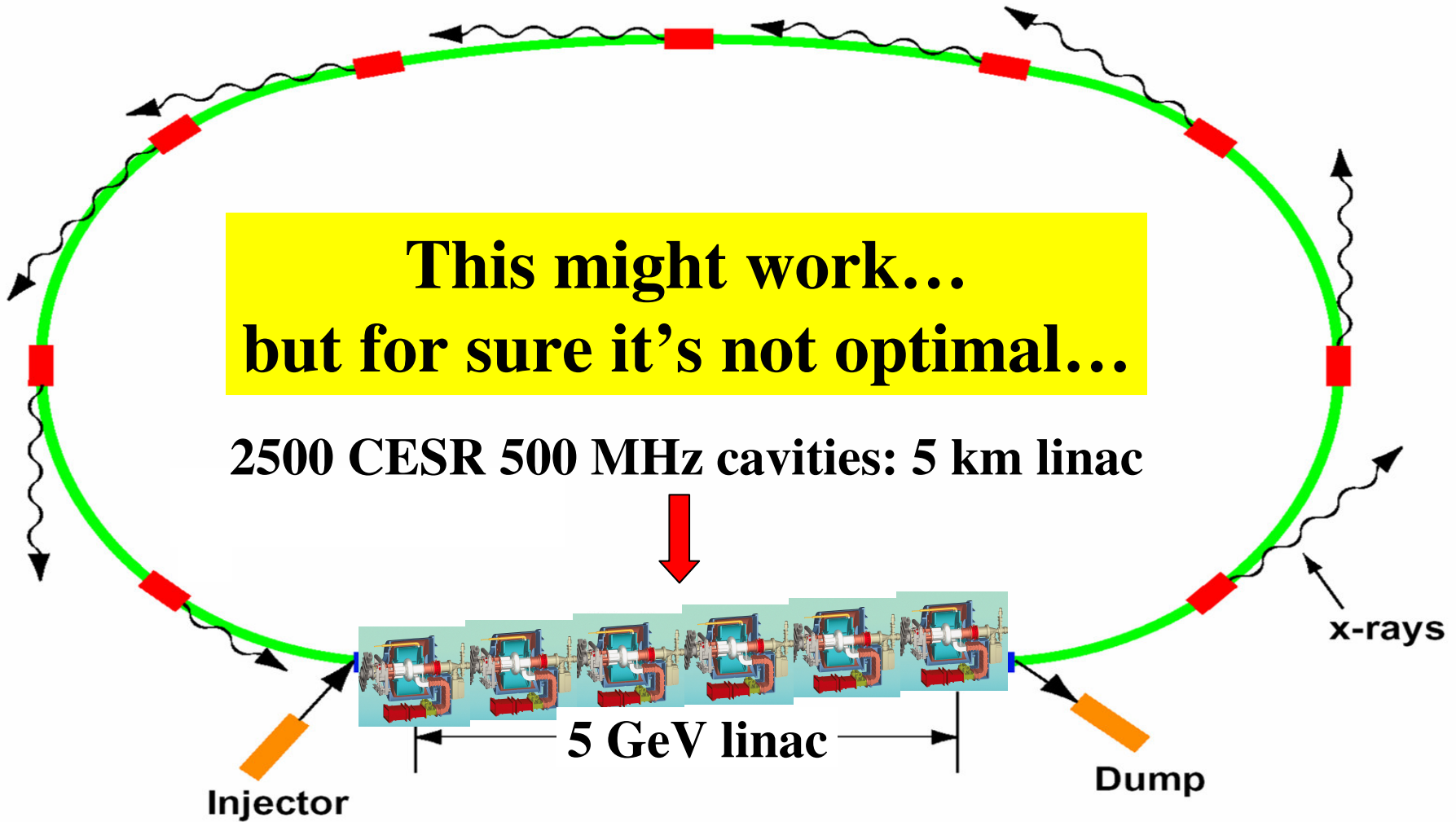



SRF linac:

- **Can deliver beams of superior quality:**
 - **Small emittance (low impedance, strong HOM damping, high gradient)**
 - **Low energy spread (precise rf control, low impedance)**
 - **CW operation at high gradient, flexible pulse trains**
- **In addition, SRF gives**
 - **High AC to beam power conversion efficiency (cost saving)**

This makes an ERL so attractive!
- **Strong HOM damping allows high beam currents, high BBU threshold.**





What's less than perfect in this "design"?

- Low fill factor
- High cryogenic losses
- Medium cw fields
- Low loaded Q
- High microphonics
- Fixed coupling (Q_L)
- HOM damping designed for long bunches

The good news is that we can make an much better ERL linac... after all the CESR cryostat has been optimized for storage rings and not ERLs.





- Preserve low emittance beams:
 - Cavity design for **low short range wakefields** (small loss-factor)
 - **Strong HOM damping** (monopole and dipole modes) up to **high frequencies** to support short bunches
 - **Small transverse fields** (coupler kicks, ...)
 - **High field stability** (amplitude and phase with small cavity bandwidth and random beam loading)
- High cw beam currents:
 - **Strong dipole HOM damping** to achieve sufficient beam stability
 - **Strong monopole HOM damping** to lower peak HOM losses
 - Shielded bellows, valves, ...



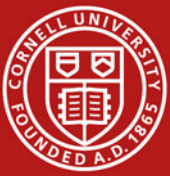

- **Efficient ERL operation:**
 - High cavity fill factor in the linac
 - High field gradients without field emission, **high Q_0**
 - Cavity design for low cryogenic losses, optimal operating temperature
 - **Low microphonics**
 - **High loaded Q cavity operation**
 - Extraction of HOM power at temperature with good cryo-efficiency up to high frequencies
- **Injector RF with strong beam loading**
 - Emittance preservation with low energy (weak) beam
 - High power transfer to beam
 - Low loaded Q operation



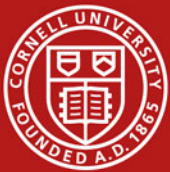

SRF for ERLs

Main Linac Parameter space

parameter	min value	max value
linac energy gain	20 MeV	5 GeV
average current	10 mA	1 A
bunch charge	10 pC	1.5 nC
bunch length	2 ps	100 ps
cavity frequency	700 MHz	1.5 GHz
cells per cavity	5	9
acc. gradient	12 MV/m	20 MV/m
unloaded Q_0	$8 \cdot 10^9$	$2 \cdot 10^{10}$
loaded Q	$2 \cdot 10^7$	$1 \cdot 10^8?$
HOM power per cavity	some 10 W	>1 kW
HOM spectrum, 95% upper freq.	1 GHz	60 GHz
amplitude/phase stability	10^{-3} / 0.1 deg	10^{-4} / 0.02 deg
ave./peak RF power per cavity	0.5 kW/1 kW	25 kW / 50 kW





Cornell University

Challenges



ERL 2005

7 March 2005

Matthias Liepe
ERL 2005 Workshop

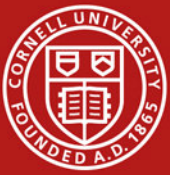

Resulting Challenges...

The component view

• SRF cavities:

- Multicell cavities, high fill factor
- Cavity design for small loss-factor
- Cavity design for small cryogenic losses
- Cavity treatment for high Q_0 , optimal operating temperature
- High field gradients without field emission
- Cavity design for strong HOM damping
- Cavity design for low microphonics (resonance frequencies)
- Cavity design for low transverse fields/kicks

• Input coupler:

- Adjustable coupling
- High cw power transfer in injector

• HOM damper:

- Strong damping of monopole and dipole modes
- Efficient power abortion up to high frequencies at temperature with good efficiency
- Small transverse kicks

• Cavity tuner:

- Integrated fast (piezo) tuner
- Designed for low microphonics (passive and active damping, resonance frequencies)

• Cryostat design / cryogenics:

- High cryogenic loads (cw!)
- Good magnetic shielding
- Designed for low microphonics (resonance frequencies, vibration decoupling, ...)
- Accurate cavity alignment

• RF power sources:

- Several kW cw power, injector RF: > 100 kW
- Good efficiency essential
- Low cost

• RF field control:

- Achieve very high amplitude and phase stability
- High loaded Q operation including fast ramps
- Control of "random" beam loading in main linac
- Active microphonics compensation
- High beam loading control in injector





What we need, what we have... What is missing?



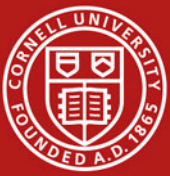

- **What we need:**
 - **Multi-cell cavities, high fill factor**
 - **Medium field gradients (15 to 20 MV/m) without field emission**
 - **Cavity treatment for high Q_0 , optimal operating temperature**
 - **Cavity design for small cryogenic losses**
 - **Cavity design for small loss-factor**
 - **Cavity design for strong HOM damping**
 - **Cavity design for low transverse fields/kicks**
 - **Cavity design for low microphonics (resonance frequencies)**



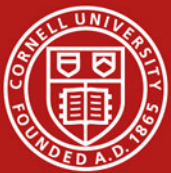

We need: 15 to 20 MV/m in linac multi-cell cavities

- We have: New JLAB FEL cryomodule:

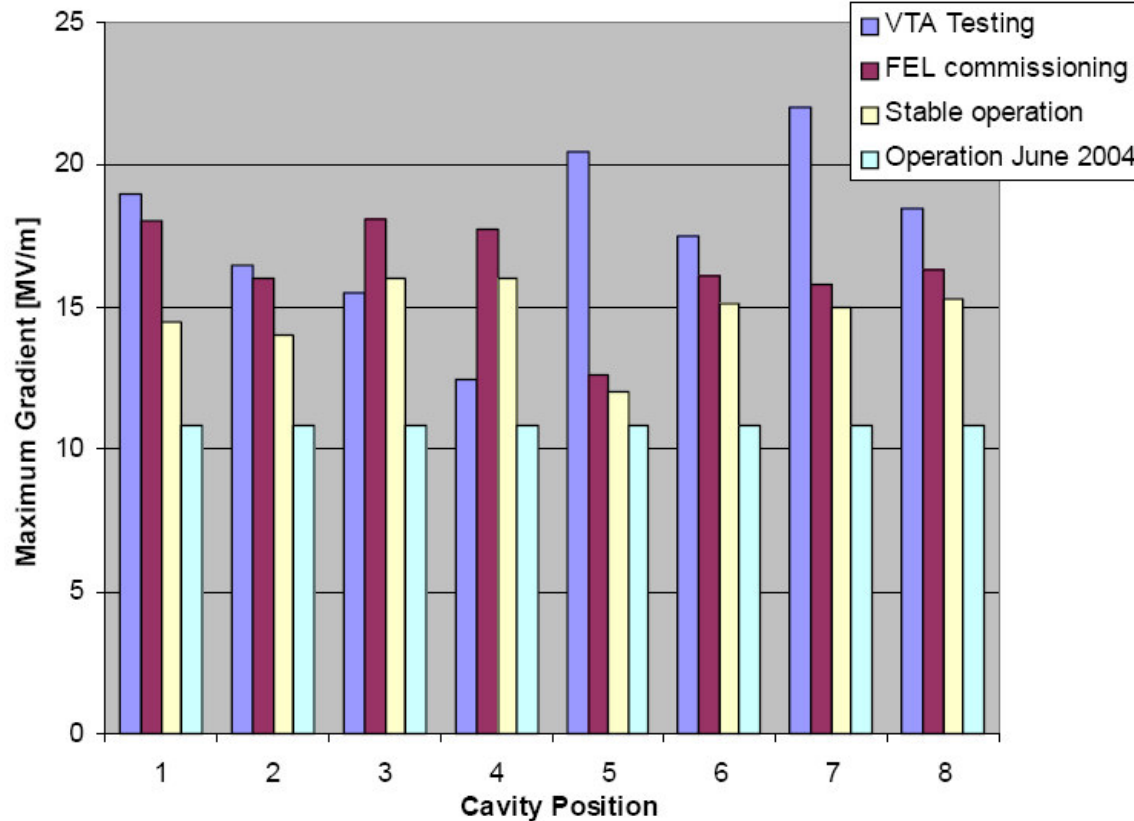

Average field:
16 MV/m

Field emission onset:
≈ 10 MV/m





We need: 15 to 20 MV/m in linac multi-cell cavities

- We have: TTF cryomodules:

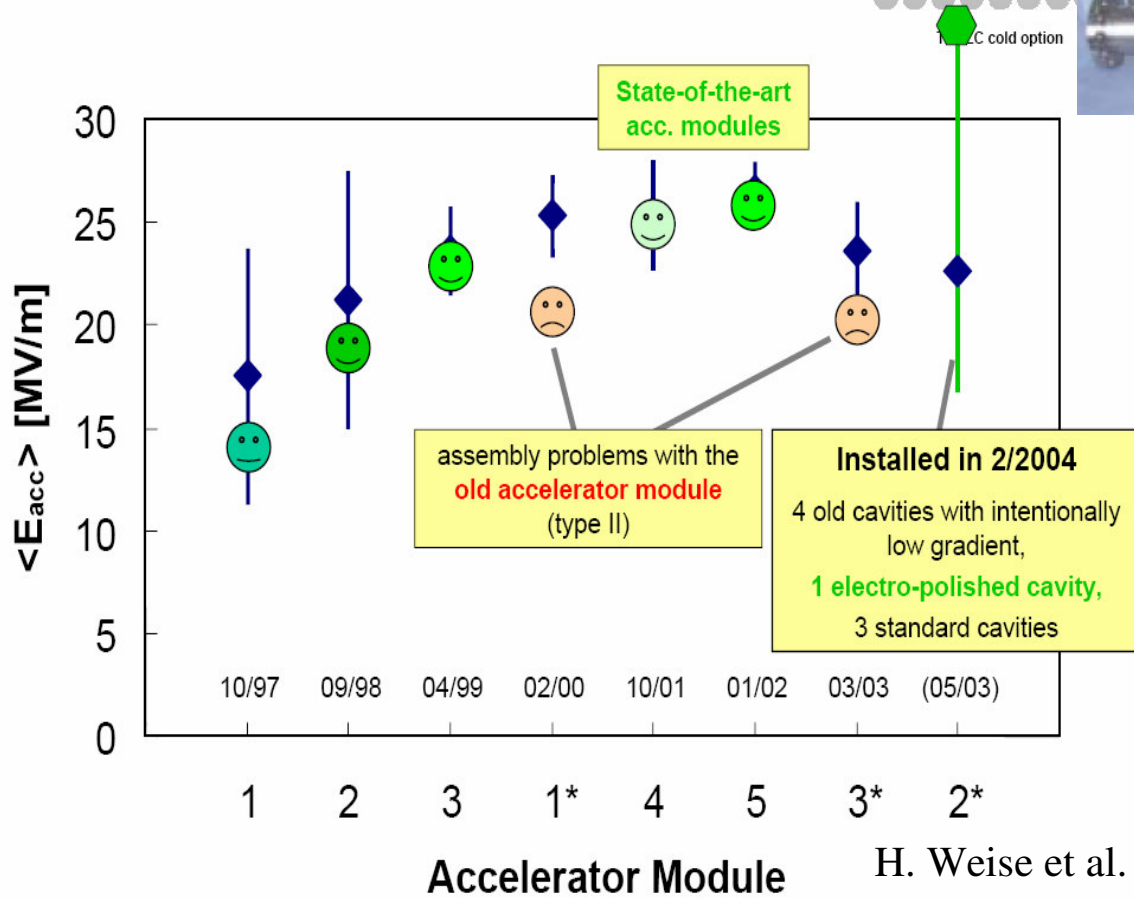

Average field (pulsed):
> 20 MV/m

Field emission onset:
> 15 MV/m



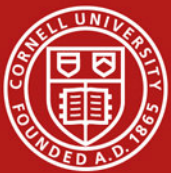

We need: 15 to 20 MV/m in linac multi-cell cavities

- We have: TTF cryomodules: Field emission / dark current

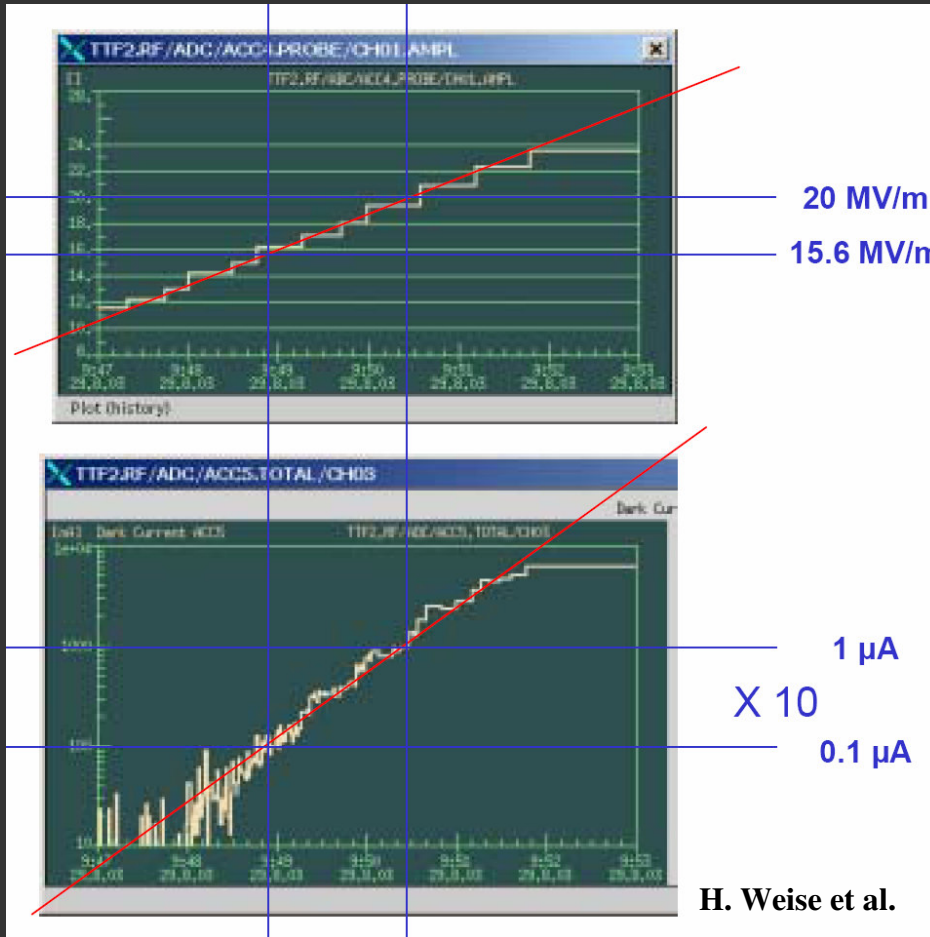

- The on-axis dark current was measured for modules ACC4 / ACC5.
- **Only one cavity in module ACC5 produced a mentionable dark current.**
- The d.c. increased by a factor 10 for each 4.4 MV/m gradient step, **starting with 100 nA at 16 MV/m.**
- Detuning of cavity no. 6 left over an integrated dark current of the order of 100 nA at 25 MV/m average gradient.
- **Dark current decreased with time!**





We need: 15 to 20 MV/m in multi-cell cavities

- Achieved fields vs. frequency (vertical acceptance tests)

Electric peak field

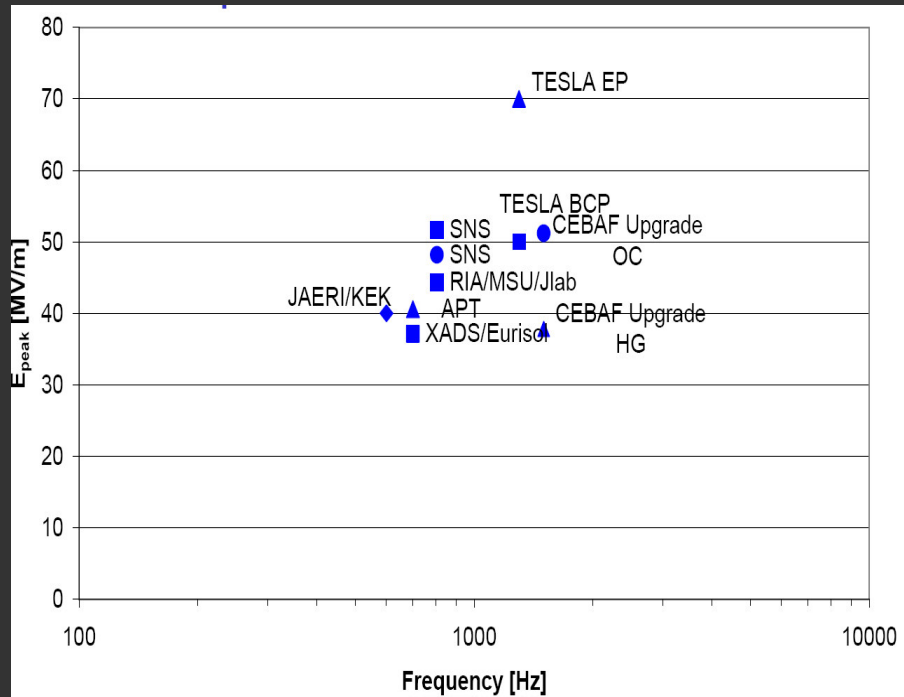

Magnetic peak field

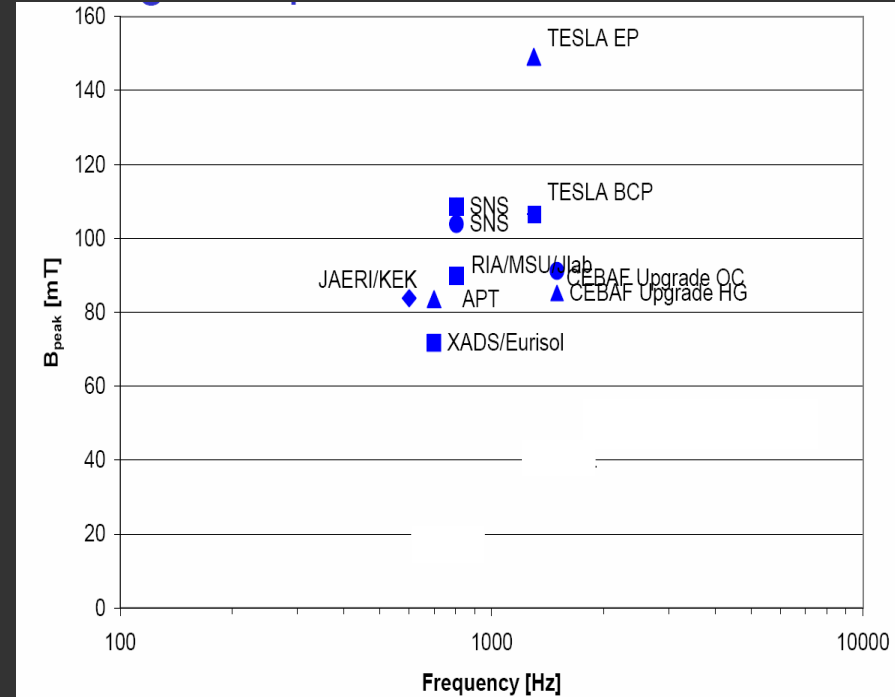

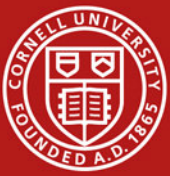

We need: high Q_0 at medium fields (15 to 20 MV/m)

- We have:

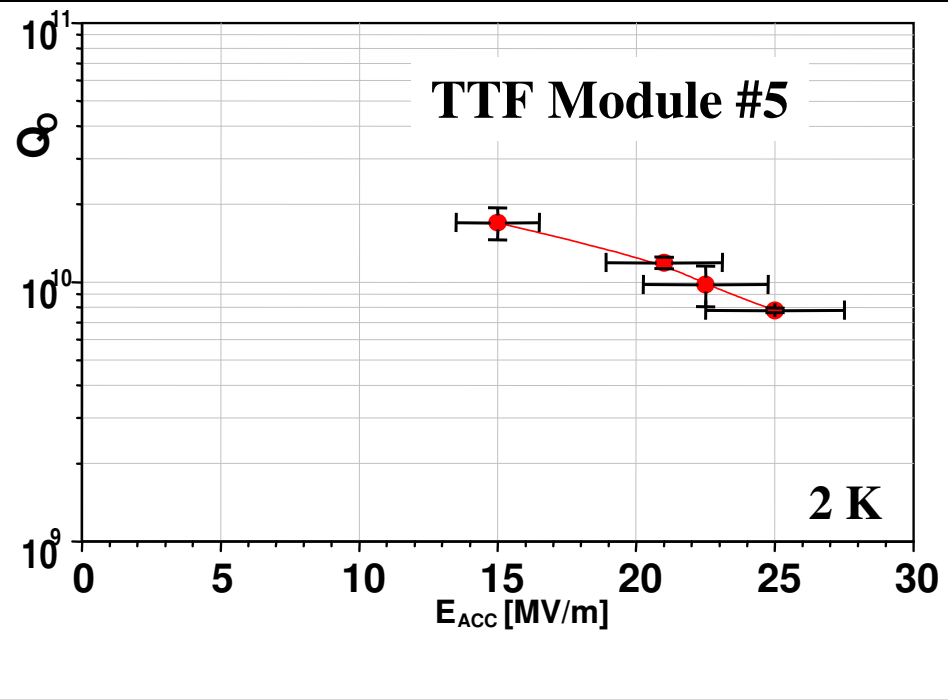
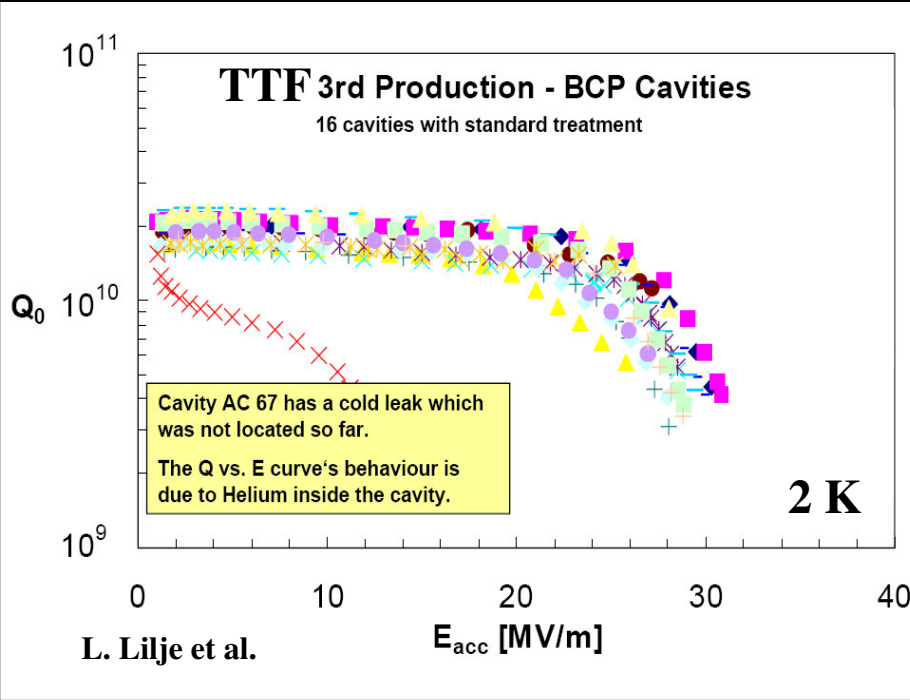

At 2 K: $Q_0 = 10^{10}$ to $2 \cdot 10^{10}$

But: Is 2 K the optimum?



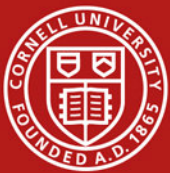

We need: high Q_0 at medium fields (15 to 20 MV/m)

- We have:

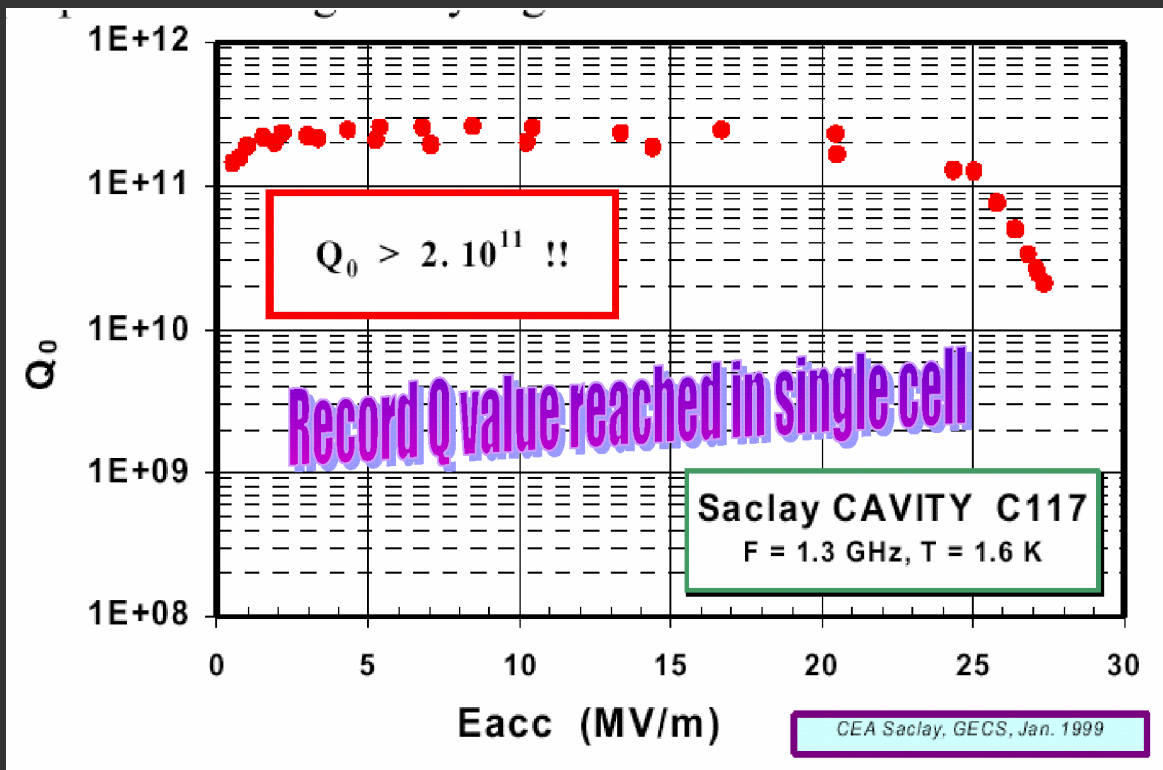

- R_{BCS} decreases strongly if T is lowered.

- Examples:

$T = 2.0 \text{ K} \Rightarrow Q = 2.6 \cdot 10^{10}$

$T = 1.8 \text{ K} \Rightarrow Q = 6.3 \cdot 10^{10}$

$T = 1.6 \text{ K} \Rightarrow Q = 1.9 \cdot 10^{11}$

$\Rightarrow 2 \text{ W/m losses at } 1.6 \text{ K}$
 instead of 20 W/m losses at 2 K? (the difference in Carnot-efficiency is small!)

But: Can we get the same in a real linac?



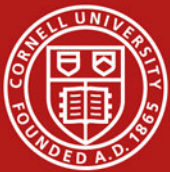

- We don't know:
 - How does one gets the best Q_0 at medium fields?
 - BCP or electro-polishing?
 - Post-processing treatment (thermal treatment, ...)?
 - Improved material control?
 - There is some substantial fluctuation in Q_0 at a given temperature!
 - What does it take to achieve and keep highest Q_0 in linac cavities?
 - **Note: Going from $Q_0 = 10^{10}$ to $2 \cdot 10^{10}$ saves MWs of power for the 2 K refrigerator!**





- ... for small cryogenic losses**
- ... for small loss-factor**
- ... for strong HOM damping**
- ... for low transverse fields/kicks**
- ... low microphonics (resonance frequencies)**

Have good numerical codes to design cavity, and many free parameters...

- frequency**
- number of cells**
- cell shape (iris and equator radius, curvature, ...)**
- beam tube radius**
- ...**





Criteria	RF-parameter	Improves when	Cavity example
Operation at high gradient	$E_{\text{peak}} / E_{\text{acc}}$ $B_{\text{peak}} / E_{\text{acc}}$ ↓	r_i ↓ Iris, Equator shape	TESLA, HG CEBAF-12 GeV
Low cryogenic losses	$(R/Q) \cdot G$ ↑	r_i ↓ Equator shape	LL CEBAF-12 GeV
Low HOM impedance	k_{\perp}, k_{\parallel} ↓	r_i ↑	B-Factory RHIC cooling

⇒ r_i is a “powerful knob” to trim the **RF-parameters**

⇒ **Can not optimize everything at the same time.**

⇒ **Design needs to be tailored for specific needs.**





Cavity Design Example: Cavity for CEBAF Upgrade



- 1.5 GHz, 7 cells
- Small iris radius, small beam tubes
- HOM damping and loss factor less important
- Optimized for high cw fields and low cryogenic losses.
- Supports only some mA beam current



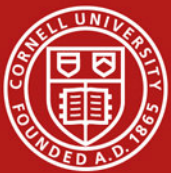

Cavity Design Example: ERL Cavity for RHIC Cooler

Optimized for low loss factor and strong HOM damping:

- Lower frequency (704 MHz), longitudinal loss factor is proportional to f^2 , transverse loss factor factor scales as f^3
- Open both irises of inner cells and end-cells (bigger $k_{cc,HOM}$)
- Large beam tube diameter to propagate HOMs
- Matched HOM frequency of inner cells to frequencies of end-cell
- Designed for several >500 mA beam current



$$f_{HOM} = 1394 \text{ MHz}$$

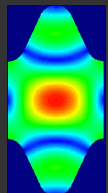

+

$$f_{HOM} = 1407 \text{ MHz}$$

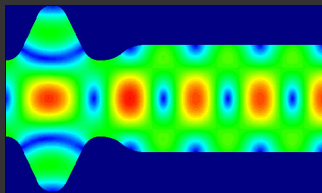

=

$$f_{HOM} = 1403 \text{ MHz}$$

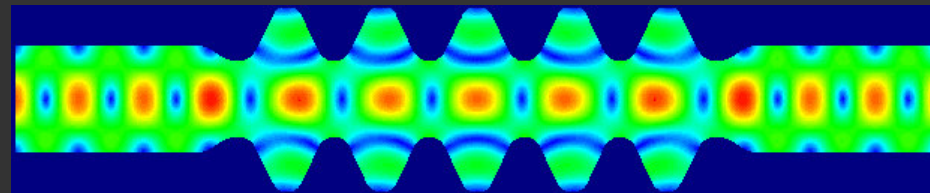



Cavity Design Example: Cornell ERL Injector Cavity

2 cells: Upper limit set by coupler power (max. energy gain per cavity). Lower limit: Maximum field gradient < 20 MV/m

Symmetric twin input coupler to avoid transverse kicks

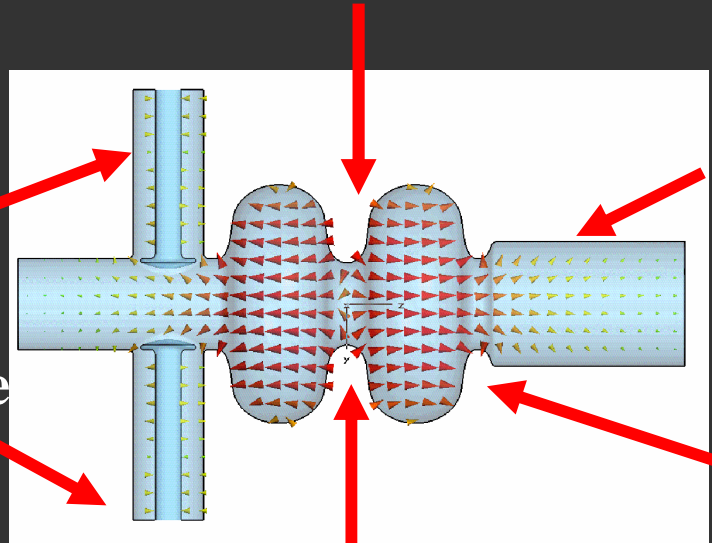

Large 106 mm diameter tube to propagate all TM monopole HOMs and all dipole modes

Reduced iris to maximize R/Q of accelerating mode

$$f_{acc} = 1.3 \text{ GHz (TESLA)}$$

Optimum: 1 GHz – 1.5 GHz

Lower f: Larger cavity surface, higher material cost,...

Higher f: Higher BCS surface resistance, stronger wakes, ...





We need: Cavity design for ... Low microphonics

- Multi-cell cavities have several low frequency mechanical resonances ($f < 200$ Hz).
- Vibration sources have typical frequencies below 200 Hz, and can **excite cavity vibration resonantly**. \Rightarrow Increased microphonics.
- Should design cavity to have high frequency resonances only. **But: Not much has been done yet...**

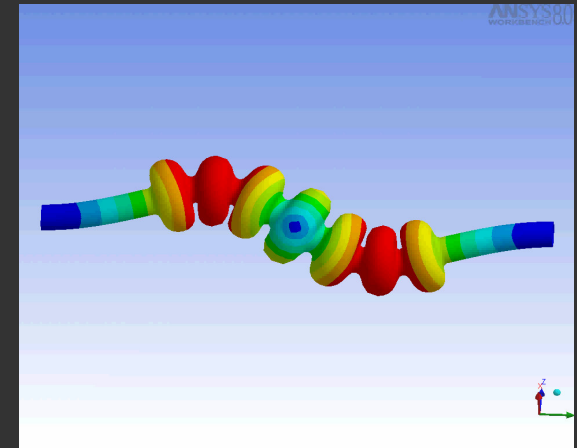
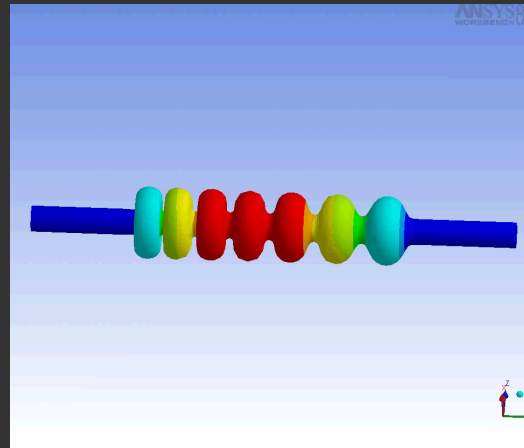
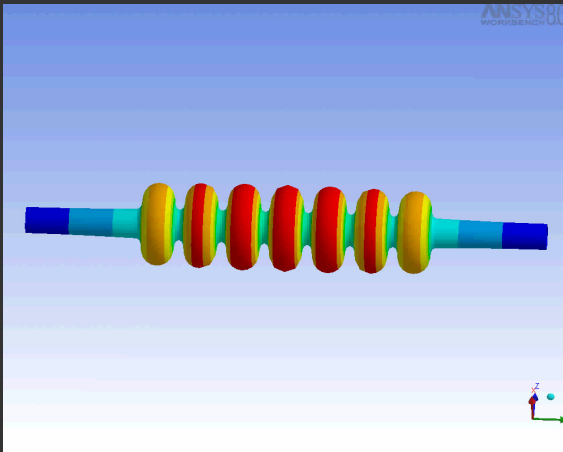



Low Microphonics Why does it matter?

In an main linac ERL cavity, the required peak drive power is proportional to the peak microphonics detuning!

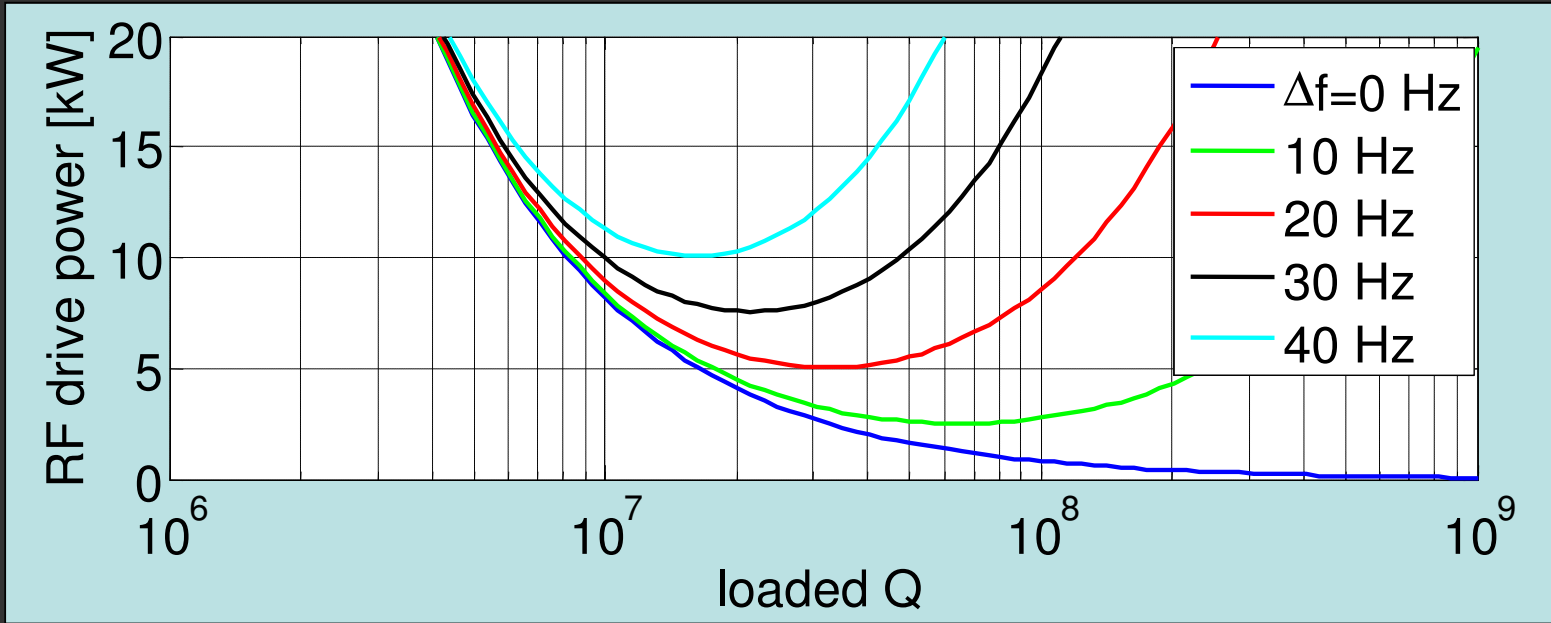

$$P_g = \frac{V^2}{8 \frac{r}{Q} Q_L} \left(1 + \left(\frac{\Delta f}{f_{1/2}} \right)^2 \right)$$

$$Q_{opt} = \frac{1}{2} \frac{f_0}{\Delta f}$$

$$P_{g,min} = \frac{V_{acc}^2}{2r/Q} \frac{\Delta f}{f}$$





- **What is missing?**
 - **Reliable medium field gradients (15 to 20 MV/m) without field emission (state-of-the-art is ≈ 15 MV/m, needs some work...)**
 - **Cavity treatment for high Q_0 , optimal operating temperature (R&D mostly focused on ILC high gradient, not medium field)**
 - **Have several nice cavity designs for high current ERLs. But: need to make real linac an pass high current, short bunch beam through cavities to confirm design goals (loss factor, HOM damping, design gradient and Q_0 , ...)**
 - **Cavity design for low microphonics (resonance frequencies)**





- **What we need:**
 - **Adjustable coupling, wide coupling range**
 - **High cw power transfer in injector (requires good cooling) and strong coupling**
 - **Low static and dynamic losses**
 - **Small transverse kick fields**



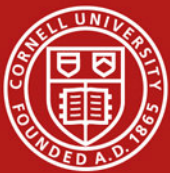

Input Coupler Coaxial or Waveguide?

Coaxial Coupler

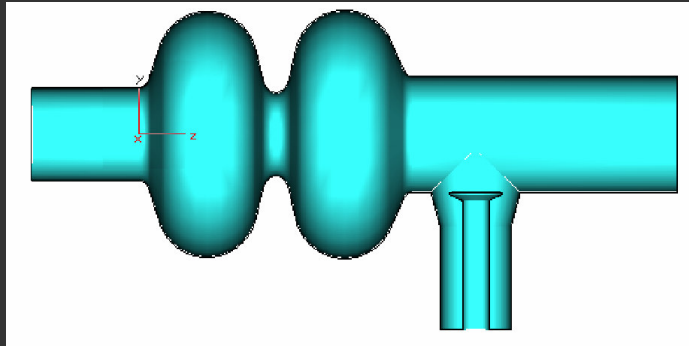

Pros:

- More compact.
- Smaller heat leak.
- Easier to make variable.
- Easy to modify multipacting power levels.

⇒ **Again, right choice depends on specific requirements.**

Waveguide Coupler

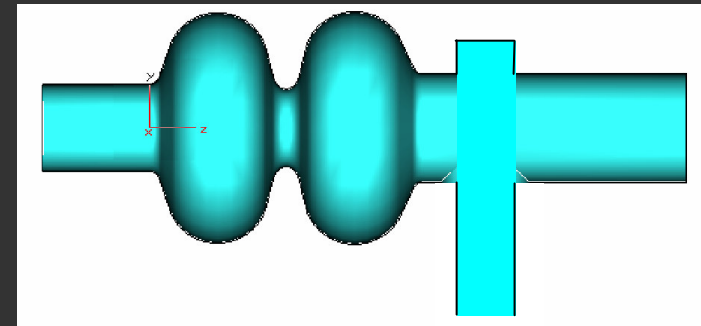

Pros:

- Simpler design.
- Better power handling.
- Easier to cool.





Input Coupler

Have a multitude of proven designs...

Facility	Freq.	Coupler	Window	Max. power	Comments
LHC	400 MHz	Coax variable (60 mm stroke)	Cylindrical	Test: 500 kWCW 300 kWCW	Traveling wave Standing wave
CESR	500 MHz	WG fixed	Disk WG	Test: 450 kWCW Oper: 300 kWCW 360 kWCW	RF window test Beam power Forward power
KEK-B	509 MHz	Coax fixed	Disk coax	Test: 800 kWCW Oper: 380 kWCW	
PEP-II	476 MHz	WG fixed	Disk WG	Test: 500 kWCW	Traveling wave RF window test
LEDA	700 MHz	-	Disk WG	Test: 800 kWCW	Similar to PEP-II
APT	700 MHz	Coax variable (±5 mm stroke)	Disk coax	Test: 1 MWCW 850 kWCW	Traveling wave Standing wave (fixed coupler)
SNS	805 MHz	Coax fixed	Disk coax	Test: 2 MW peak	7.8% DC: 1.3ms, 60 pps, similar to KEK-B
JLab FEL	1500 MHz	WG fixed	Planar WG	Test: 50 kWCW Oper: 30 kWCW	RF window test, very low ΔT
TESLA (TTF3)	1300 MHz	Coax variable (17 mm stroke, factor of 20)	Cylindrical	Test: 1.8 MW pk 4 kW cw >10 kW cw	TW, pulsed TW TW, air cooling



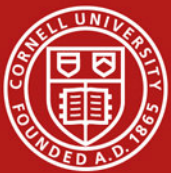

- Example: Cornell ERL injector input coupler:

- $f = 1.3 \text{ GHz}$
- $P > 50 \text{ kW cw}$
- Multipacting free geometry
- Air cooled inner conductor
- Twin coupler design two zero coupler kicks
- Strong, adjustable coupling ($Q_{\text{ext}} = 5 \cdot 10^4 \text{ to } 4 \cdot 10^5$)

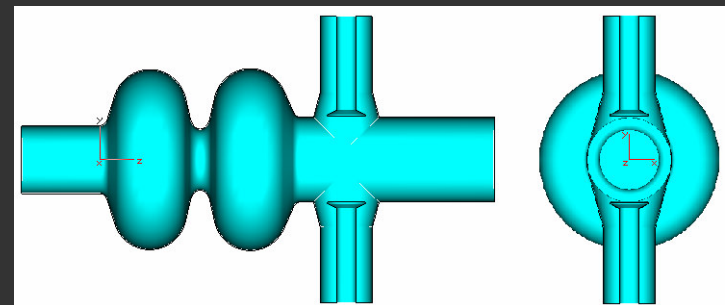
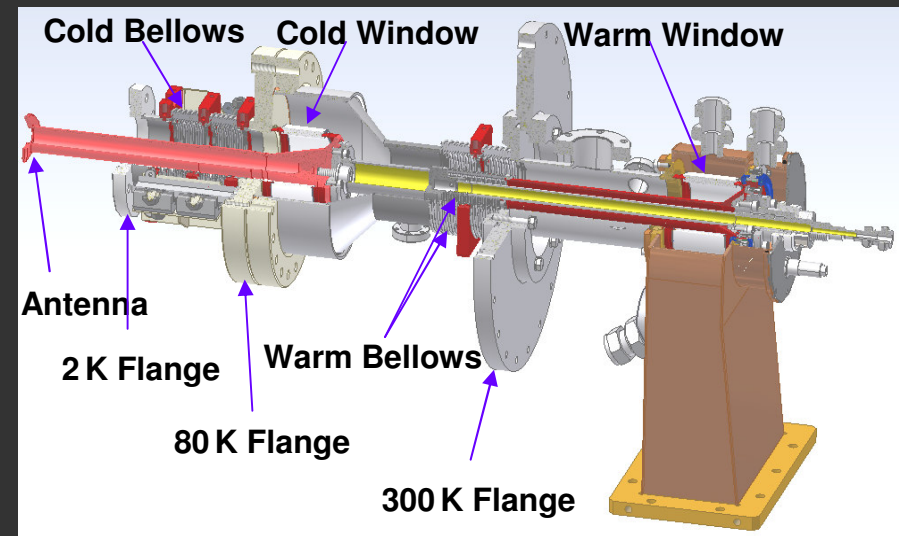



- What is missing?
 - Several coupler designs exist. But: Future ERL cw injectors will require very high power handling. **Prototype designs exist, but need to be tested!**
 - Where is the limit? Field in injector often limited by coupler power handling, not surface fields!
 - Need verify calculated coupler-kicks, and understand impact on emittance in more detail.



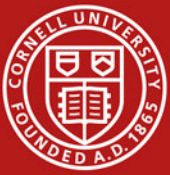

- **What we need:**
 - **Strong damping of monopole and dipole modes**
 - **Efficient power abortion up to high frequencies at temperature with good efficiency (> 80 K)**
 - **Avoid significant HOM losses at 2 K or in input coupler**
 - **Small transverse kicks for emittance preservation**



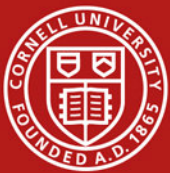

HOM damper: Options

trapped and
quasi trapped modes

propagating modes

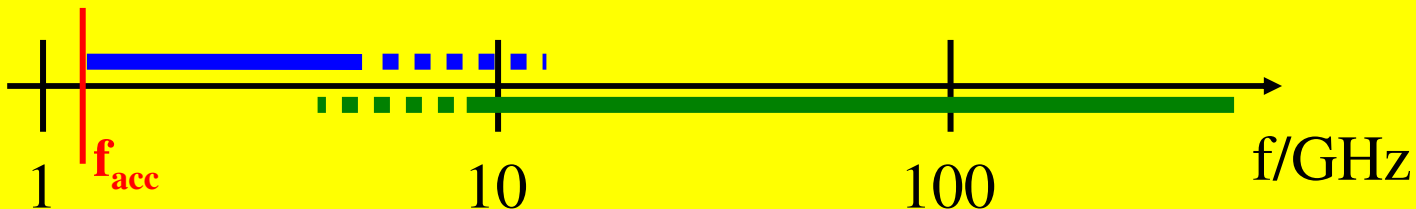

HOM couplers

HOM beam-pipe absorber

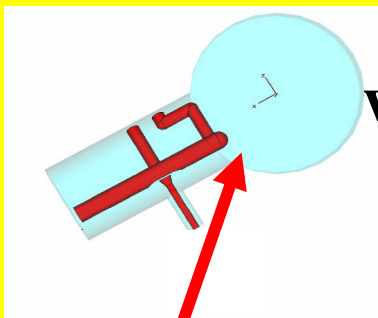

waveguide couplers

coupler kicks?

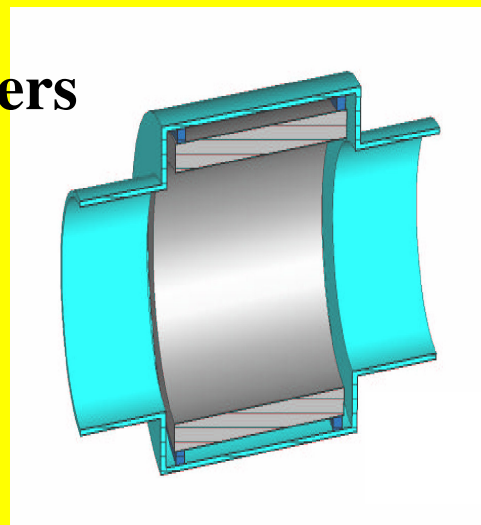
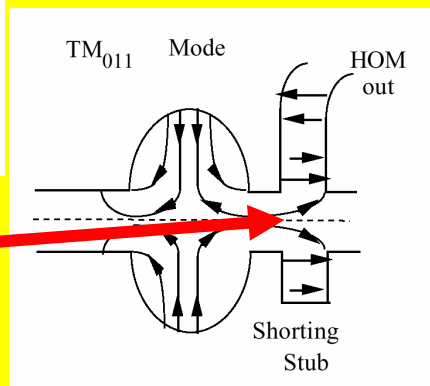

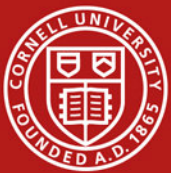

ERL HOM damping: High current and short bunches

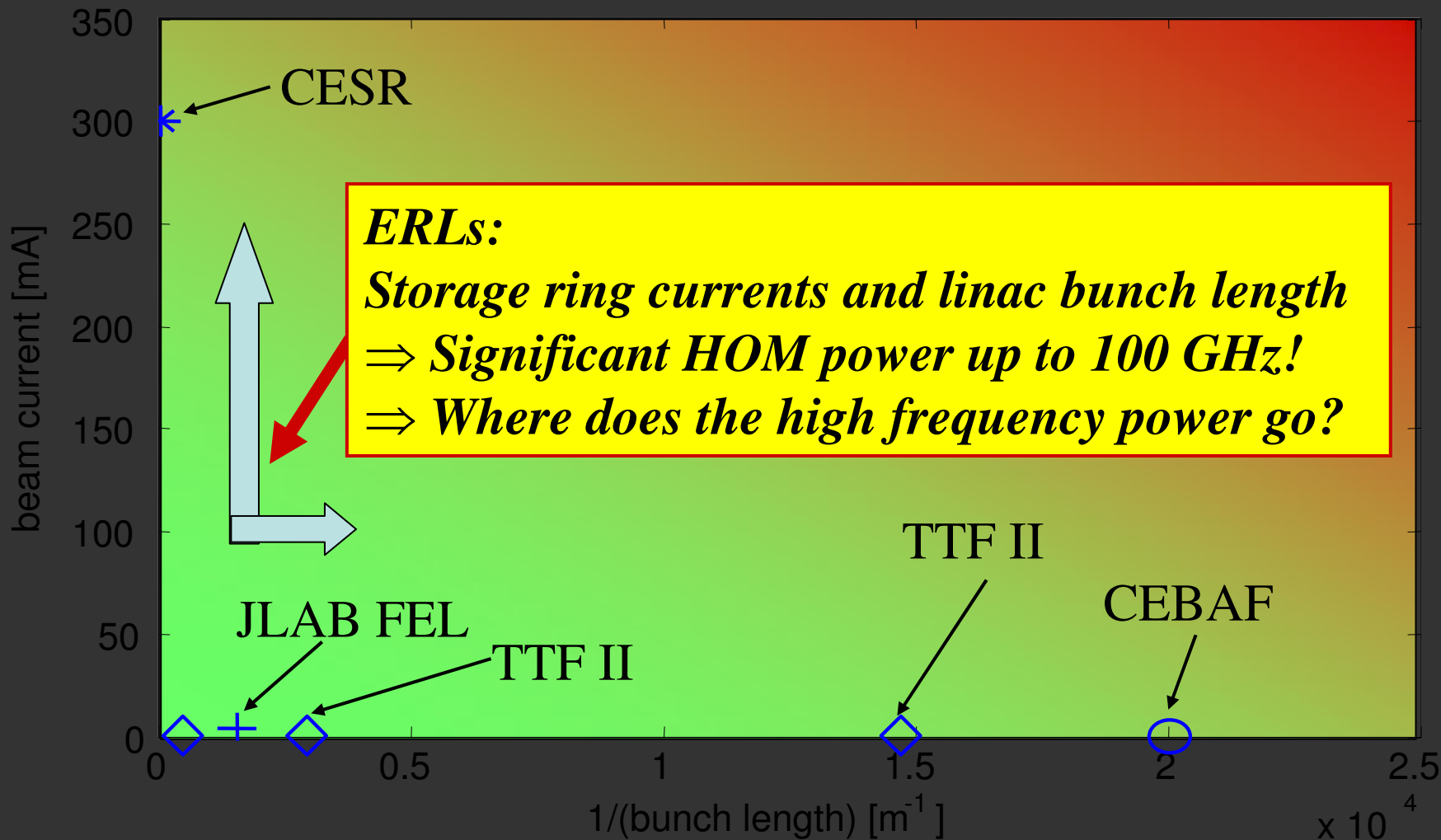

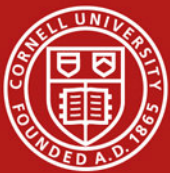

HOM damper: Beam-pipe absorber

S.C. storage ring cavities are using ferrite based beam pipe absorbers since many years. Example: CESR

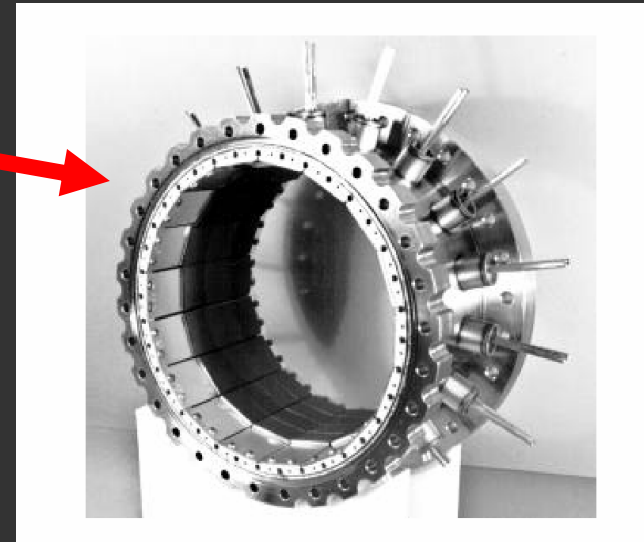
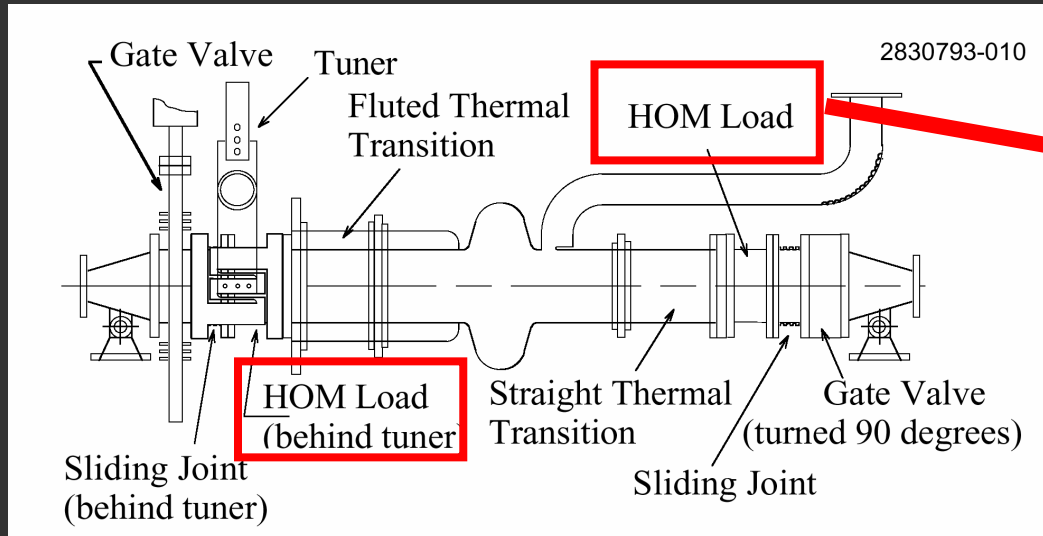

Based on the good performance of these absorbers, many **ERL proposals adopted this concept.**

But: High frequency HOM spectrum in ERLs requires **efficient absorption at multi-10 GHz frequencies.**



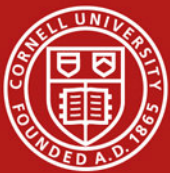

HOM damping: BNL ERL RHIC Cooler

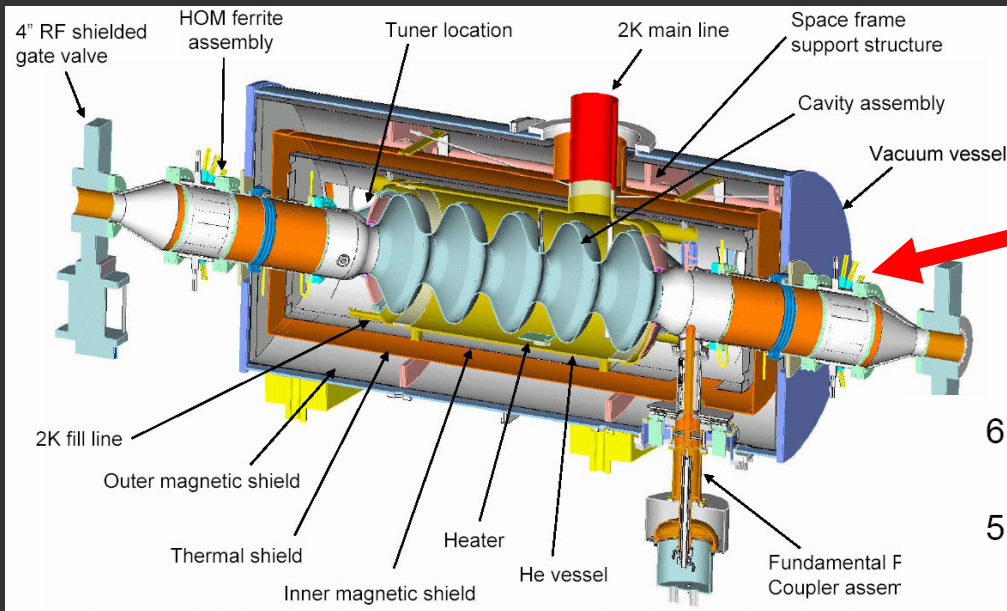

CESR style ferrite beam pipe absorbers

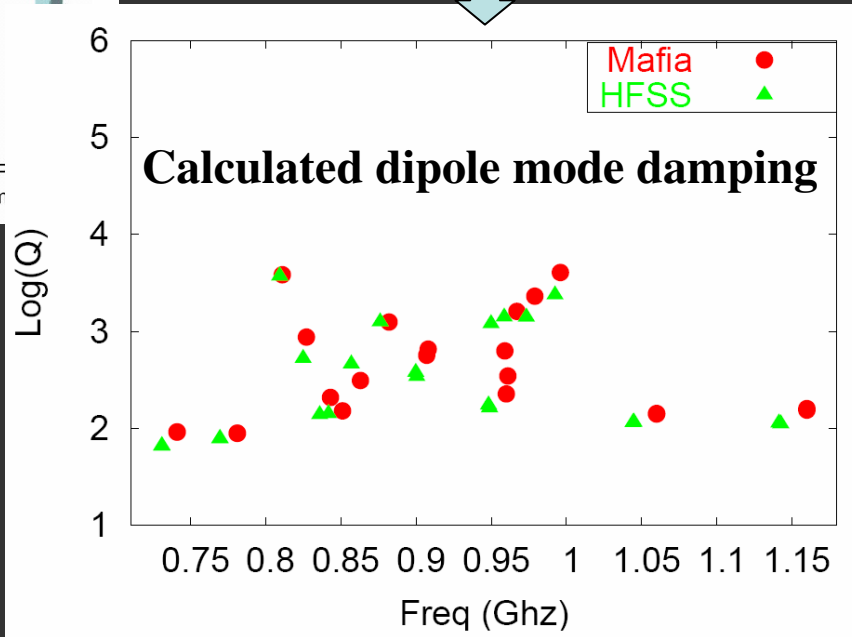



Cornell University

Beam-pipe absorber

Example: Cornell ERL Prototype

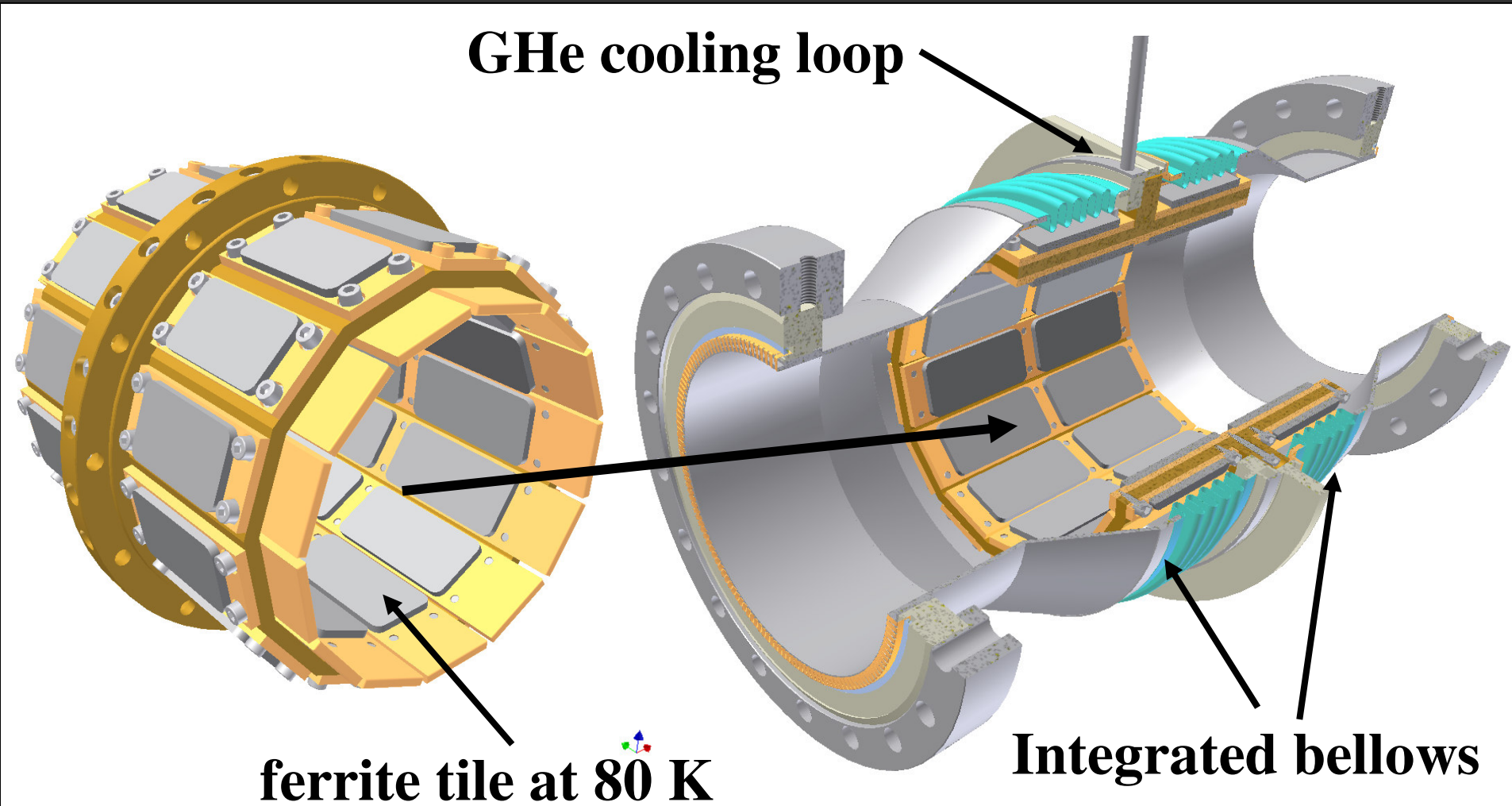

ERL 2005

7 March 2005

Matthias Liepe
ERL 2005 Workshop

38

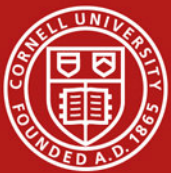

Cornell ERL Absorber: Measured RF losses at 80 K

Measured RF absorption efficiency at 80 K as function of frequency for different materials

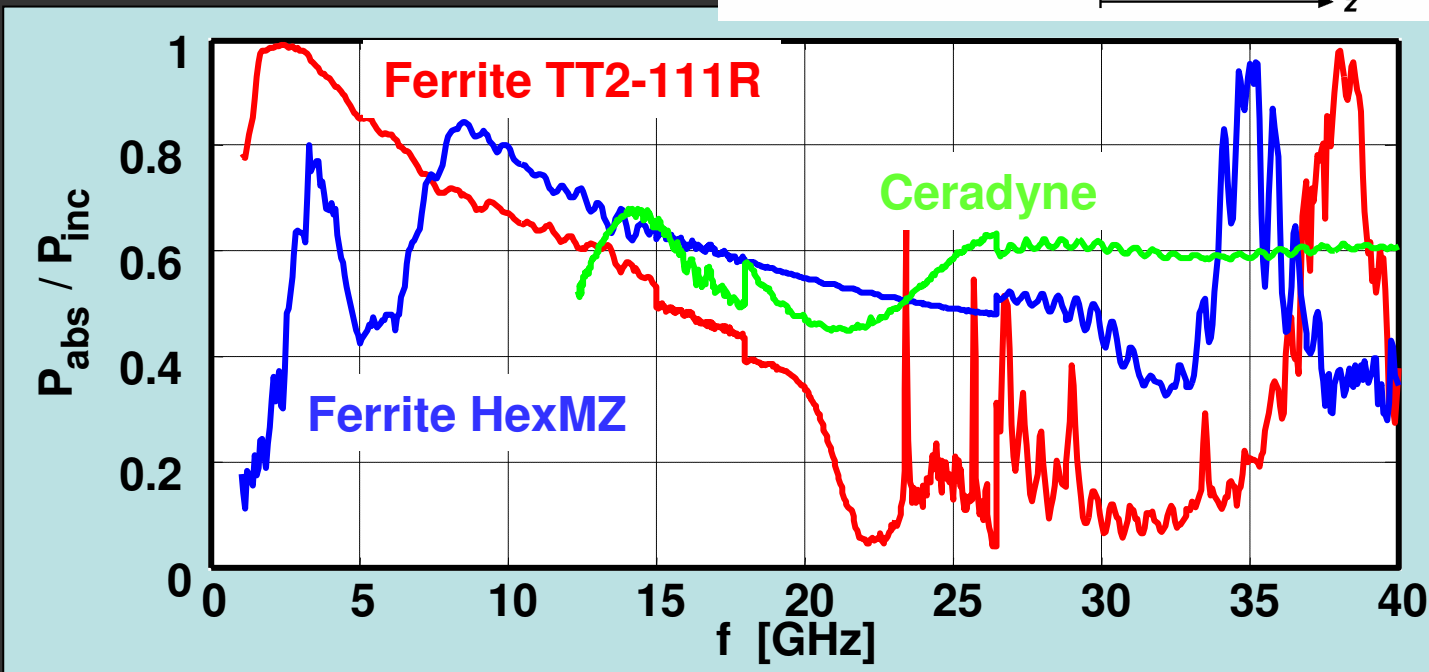
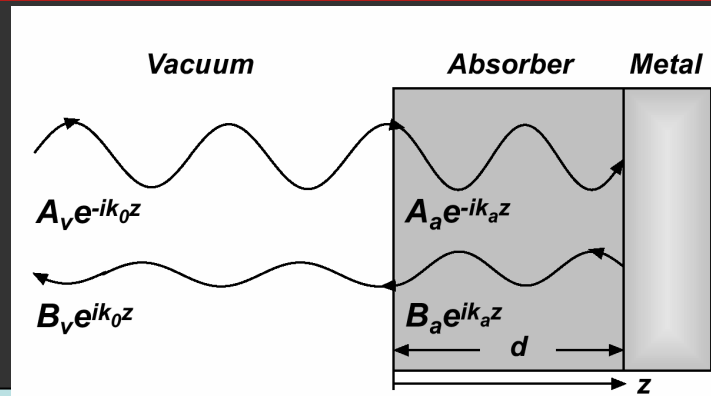

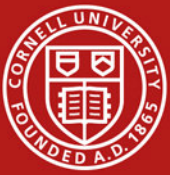

- What is missing?
 - Lots of HOM damping simulations have been done. Storage ring cavities have demonstrated very low Q_s . But: How accurate are those simulations?
 - What happens at high frequencies? Where is the high frequency HOM power absorbed? How much goes to 2K?
 - ⇒ **Need beam test with high current and short bunches!**
 - Need verify calculated HOM coupler-kicks, and understand impact on emittance in more detail.





- What we need:
 - Integrated fast (piezo) tuner
 - **Design for low microphonics (passive and active damping, resonance frequencies). This needs more work!**
- Several designs with integrated piezos have been tested:

SNS tuner

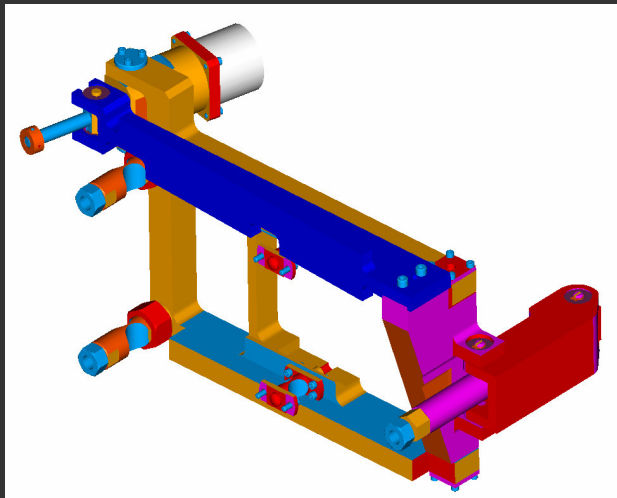

TTF blade tuner

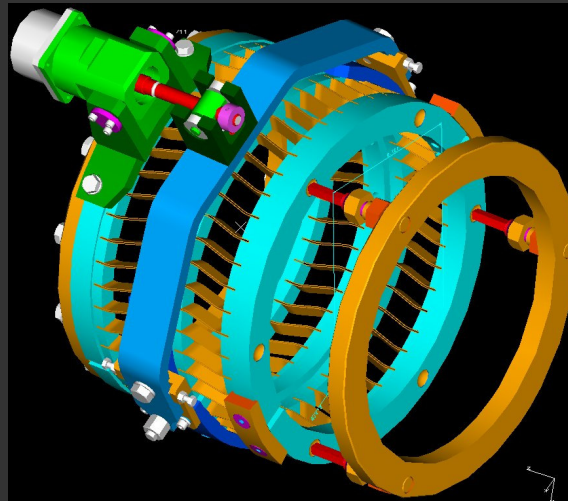

JLAB tuner

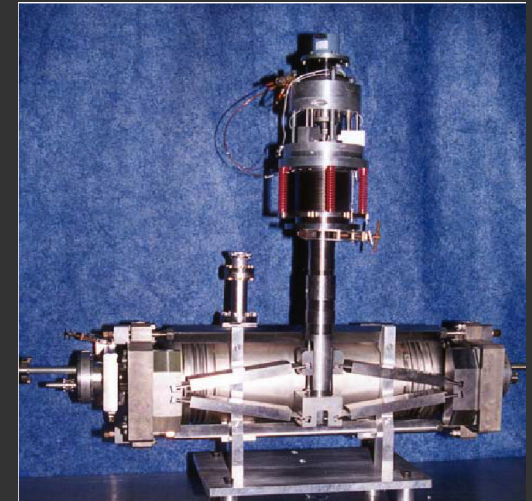



- **What we need:**
 - **Cryogenic design to support high cryogenic loads (cw cavity operation!)**
 - **Designed for low microphonics (resonance frequencies, vibration decoupling, ...)**
 - **Good magnetic shielding (high Q_0 !)**
 - **Accurate cavity alignment ($\approx \pm 1$ mm)**





- **High gradient cw operation: dynamic cavity heat load dominates at 2 K: typical some 10 W per cavity**
- **Module design:**
 - Heat transfer through LHe \Rightarrow need large enough pipes / cross sections
 - Mass transport of helium gas \Rightarrow need large enough pump lines
 - HOM losses \Rightarrow need cooling of absorbers with efficient heat transfer to coolant
- **Complex cryogenic system...many limitations are highly empirical (max. heat transfer through LHe, max. vapor velocity, ...)**

But: Existing cryostats give good database!





Cryostat design: Cavity alignment

• Example: TTF Cryostat

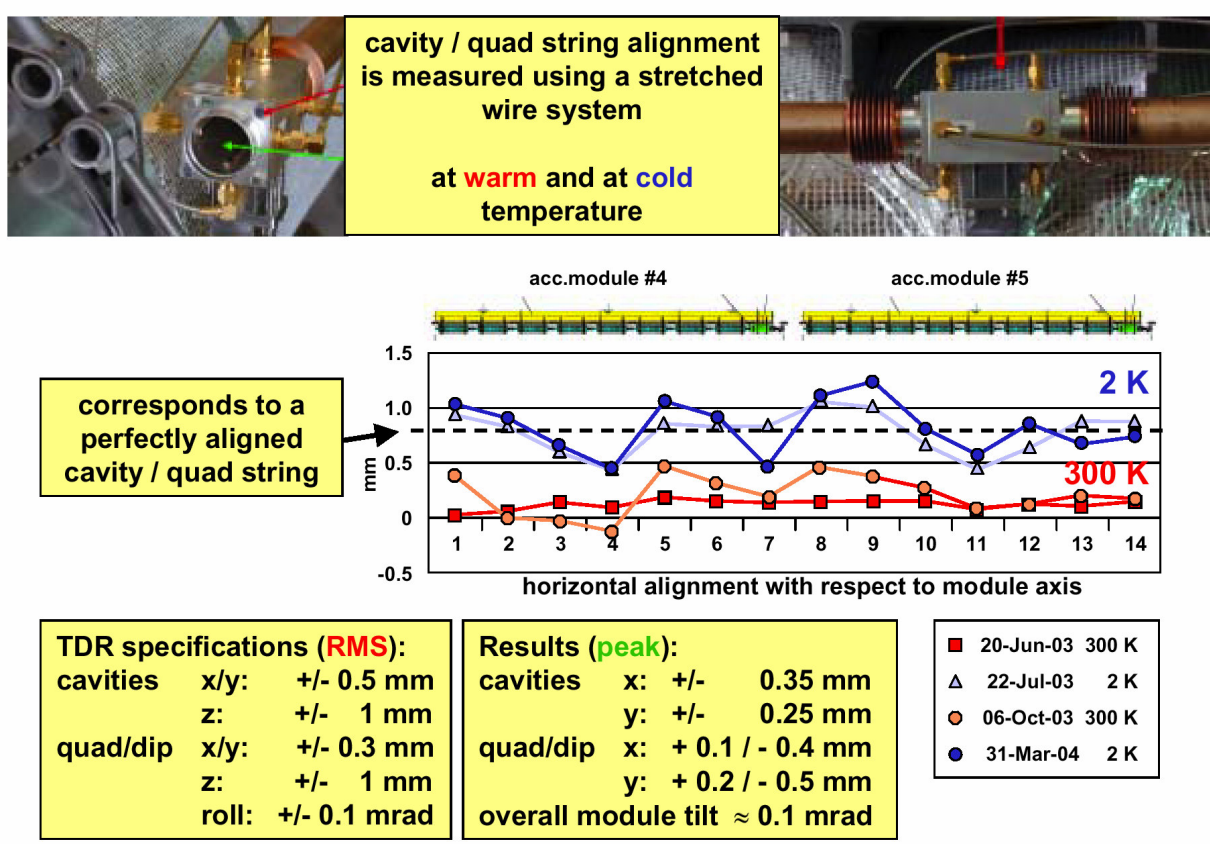

• Similar values have been obtained in JLAB cryostats, ...





Cryostat design: Microphonics

- Cryostat must isolate cavities from external vibrations to achieve lowest microphonics.
- Very low microphonics level have been demonstrated: But: Significant differences between cavities and temporal!

Example: JLAB 7-cell FEL module:

measured:

$\sigma \approx 1$ Hz

Peak < 8 Hz

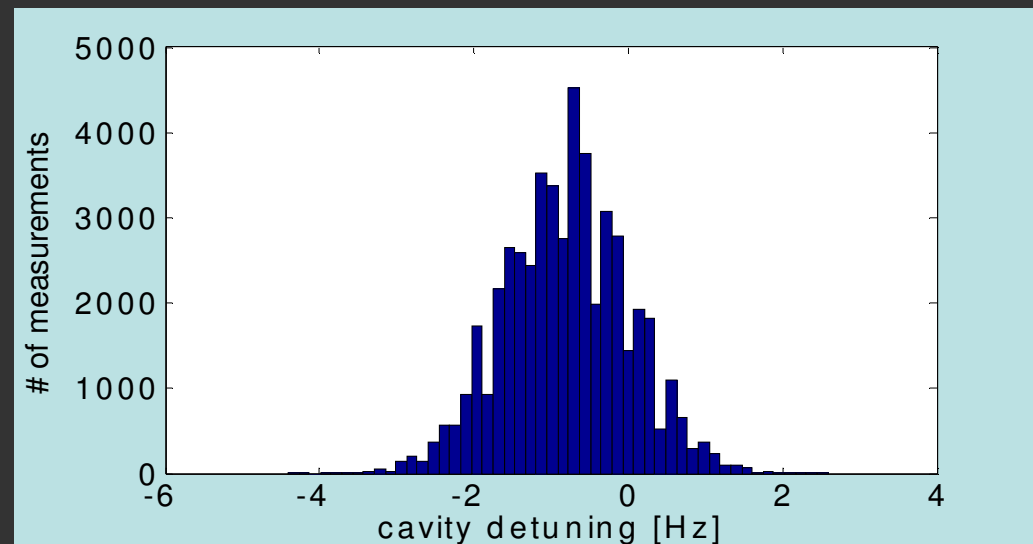

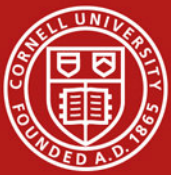

Cryostat designs: Some examples



JLAB

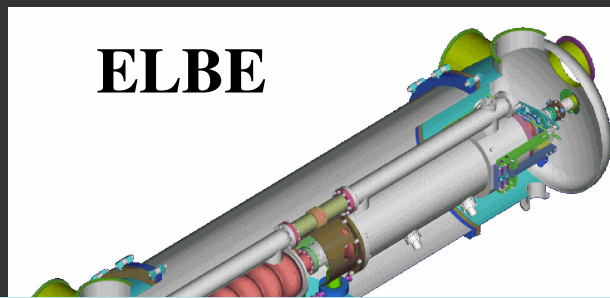

ELBE

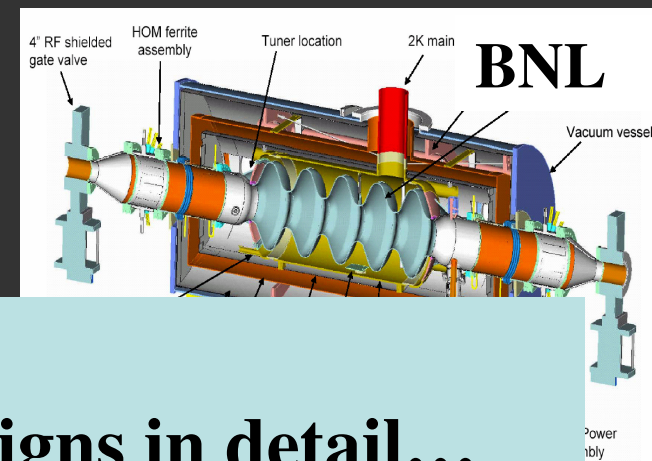

BNL

**Don't worry...
I'm not going through all these designs in detail...
We all can read papers...**

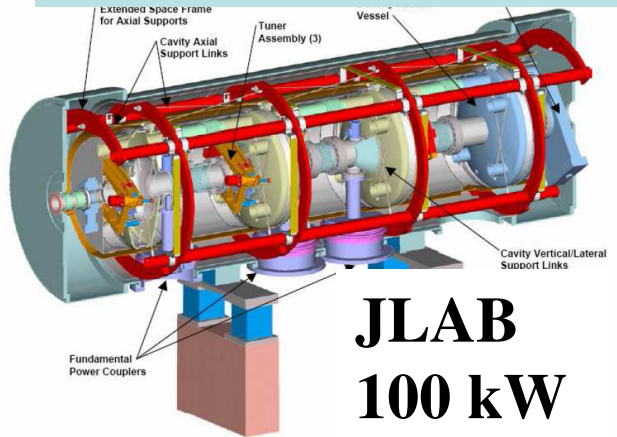

**JLAB
100 kW**

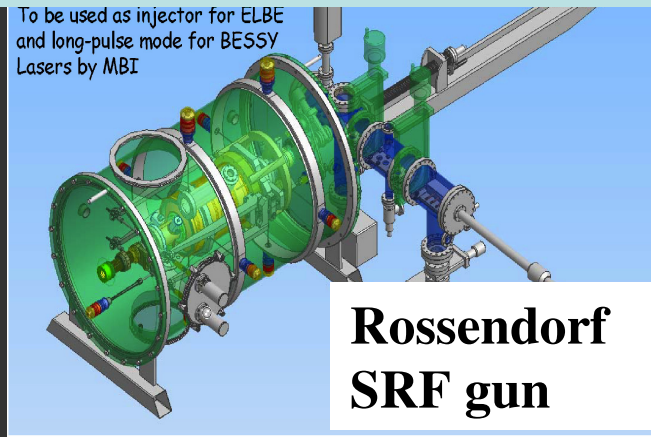

**Rossendorf
SRF gun**

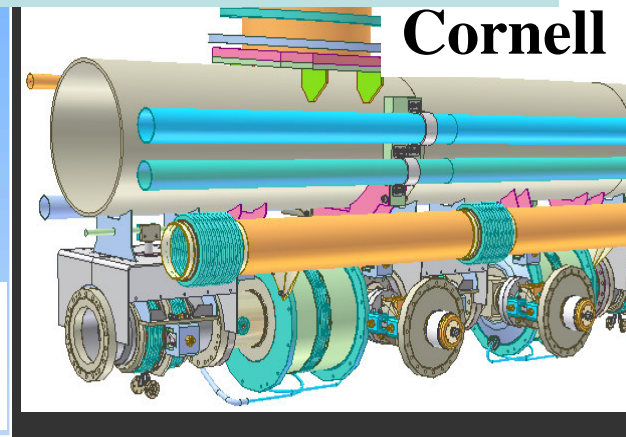

Cornell



- **What is missing?**
 - **Optimization of cryostat might take several iterations. High load cryogenics is very complex, but good knowledge base exists.**
 - **Need to improve magnetic shielding to support highest Q_0 .**
 - **Mechanical design of cryostat needs to include mechanical resonances and vibration isolation to achieve lowest microphonics. Can be optimized.**



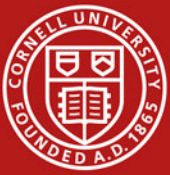

- **What we need:**
 - **Main linac: up to several kW cw power**
 - **Injector RF: > 100 kW; the more the better...**
 - **Good efficiency essential**
 - **Low cost**





- What we have:

- Many cw klystrons at different frequencies, more to come...
- Cw IOTs, recently also above 1 GHz
- Several manufactures, have discovered ERLs as potential market and are very supportive

Klystrons by CPI

Model	Frequency	Output Power, kW	Duty
VKP-7953A	500 MHz	70	CW
VKP-7953B	500 MHz	100	CW
VKP-7957A	500 MHz	800	CW
VKP-7958A	500 MHz	800	CW
VKP-7952A	700 MHz	1000	CW
VKP-8291A	805 MHz	550	.09
VKP-7955	805 MHz	200	.002
VKL-7811M	1.3 GHz	5	CW
VKL-7811ST	1.3 GHz	10	CW
VA-963A	1.3 GHz	6500	.001
VKL-7796	1.3 GHz	4000	.075
VKL-7811W	1.497 GHz	5	CW
VKL-7966A	1.497 GHz	100	CW

1.3 GHz IOTs, > 15 kW



IOT-Prototype by CPI

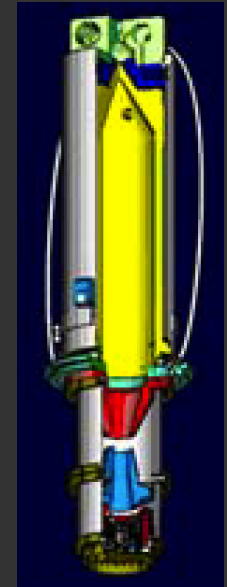



- **What is missing?**
 - **> 1GHz, very high cw power klystrons or IOTs for injector**
 - **Efficiency, efficiency, efficiency...IOTs are promising, especially for the main linac, where the required power output varies significantly**
 - **Low cost \approx 1 kW solid state amplifiers?**





- **What we need:**
 - **Achieve very high amplitude and phase stability**
 - **Control of “random” beam loading in main linac**
 - **High beam loading control in injector**
 - **High loaded Q operation including fast field ramps (fast trip recovery)**
 - **Active microphonics compensation (for high Q_L operation)**





- What we have:

JLAB FEL, ELBE, SDALINAC: Operate cavities at $Q_L \approx 2 \cdot 10^7$ with good amplitude and phase stability.

But: Have also very low microphonics (peak < 10 Hz!)

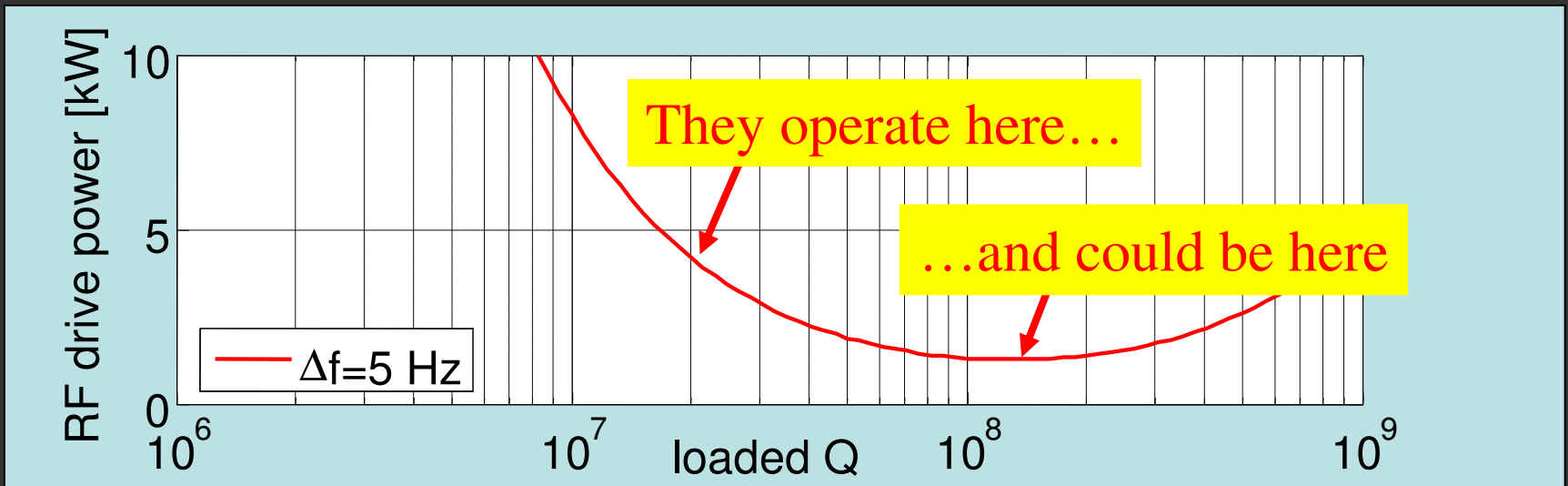

⇒ Low microphonics levels would allow to run an ERL at a $Q_L \approx 10^8$!



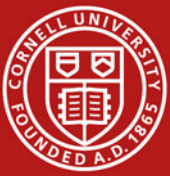

Cornell has developed an RF control system to operate cavities at very high loaded Q:

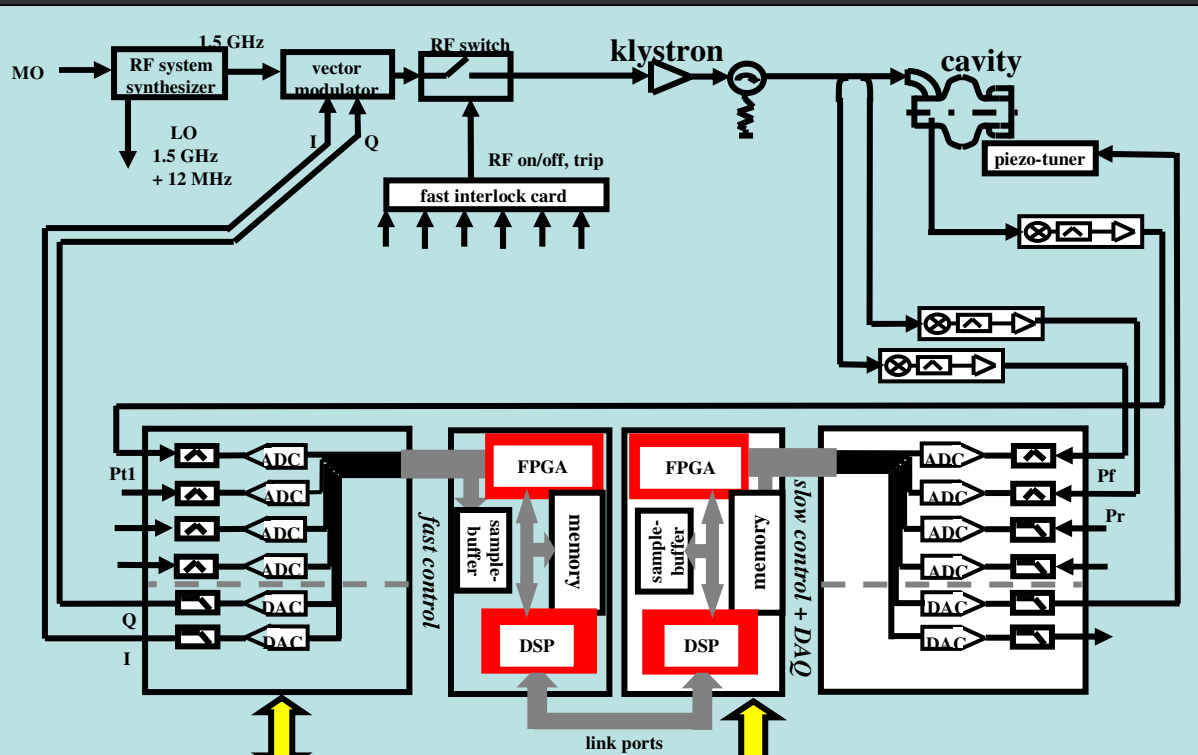

- Installed system at JLAB FEL to control field in one 7-cell cavity
- Operated cavity at $Q_L = 1.2 \cdot 10^8$ with 5 mA energy recovered beam.
- Cavity half bandwidth: 6 Hz

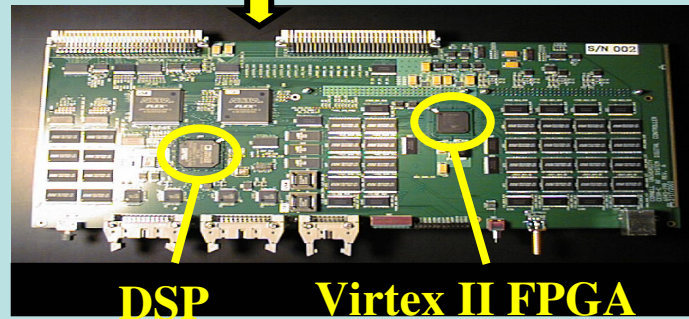
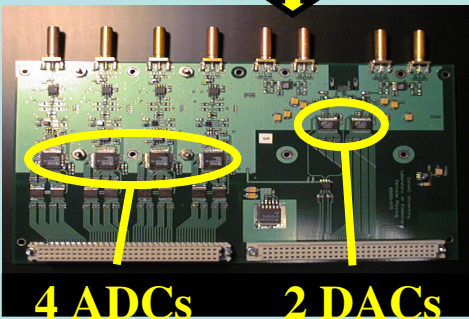

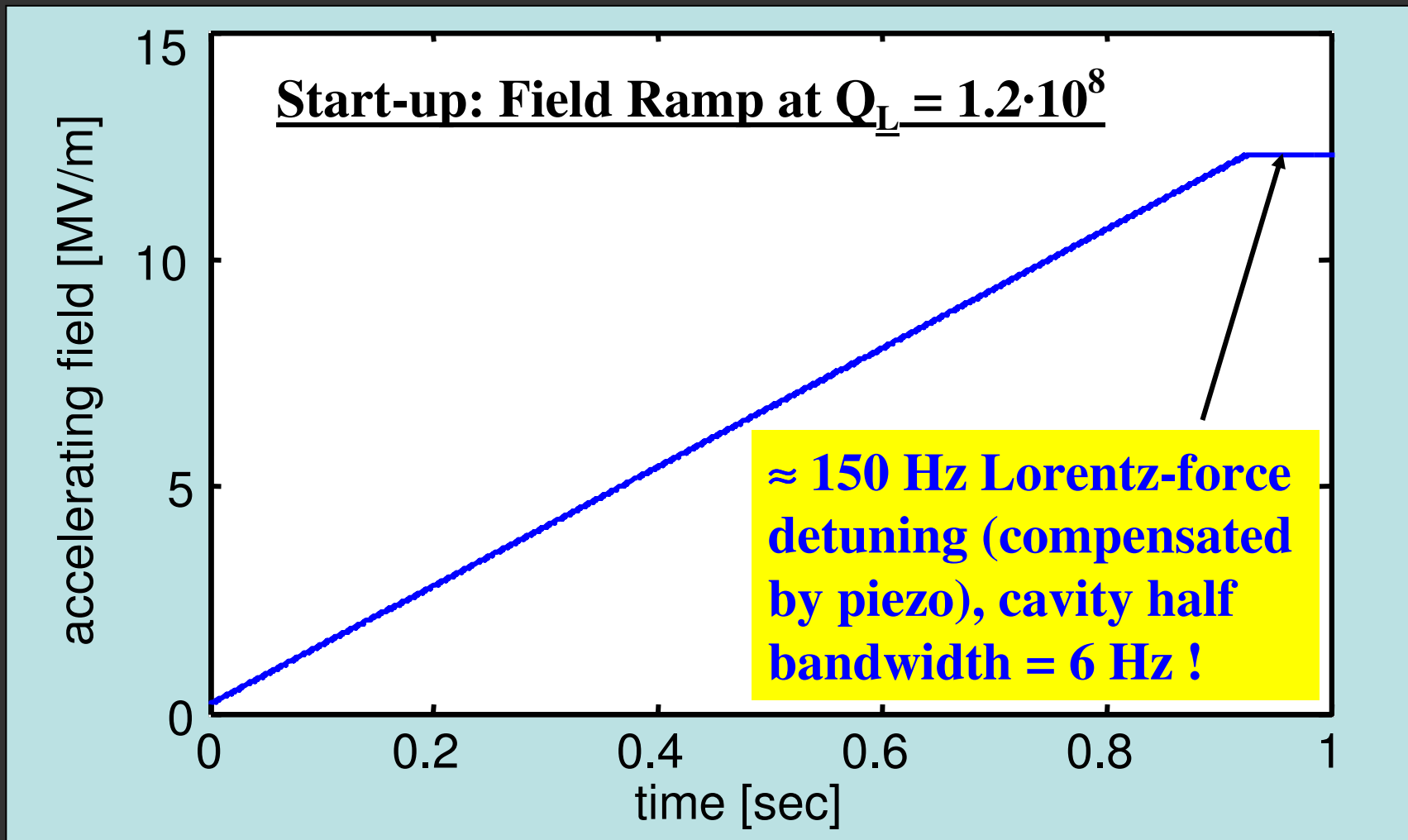
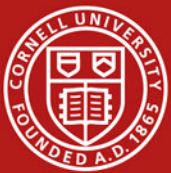

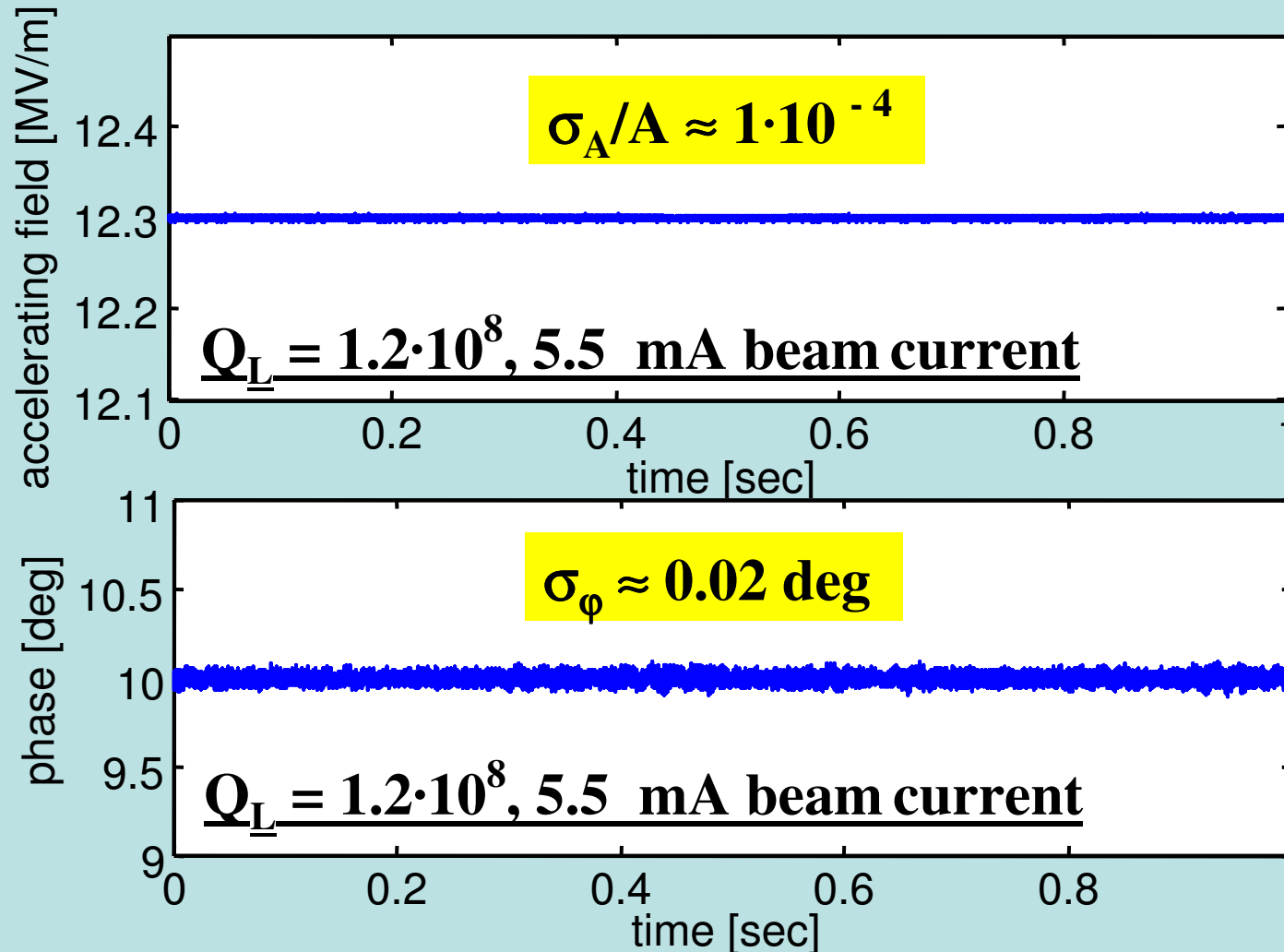

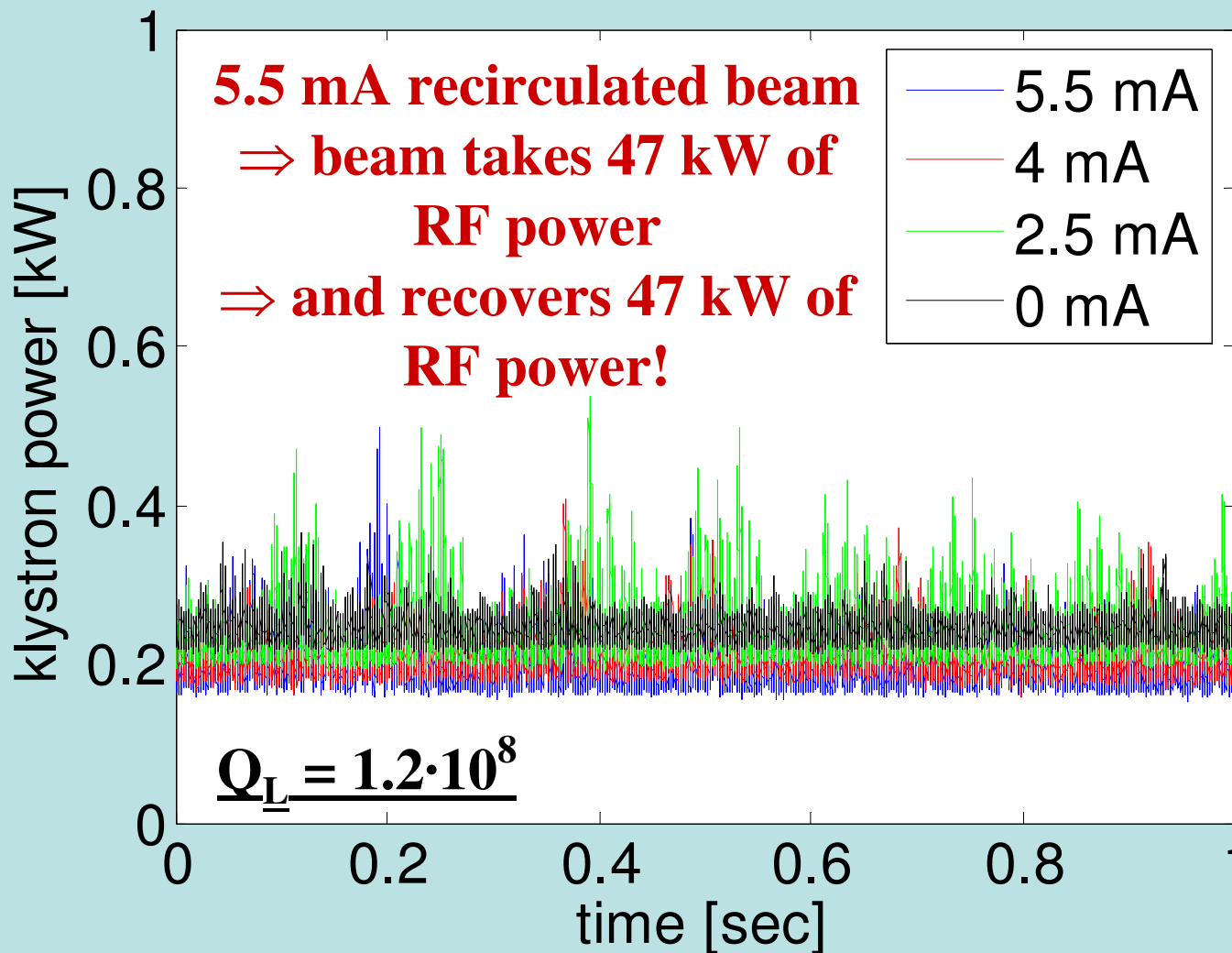
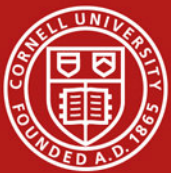

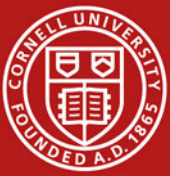

- Very exciting field with great potential to reduce microphonics. But: Needs well designed mechanical system to start with...
- First steps:

Work at Fermilab

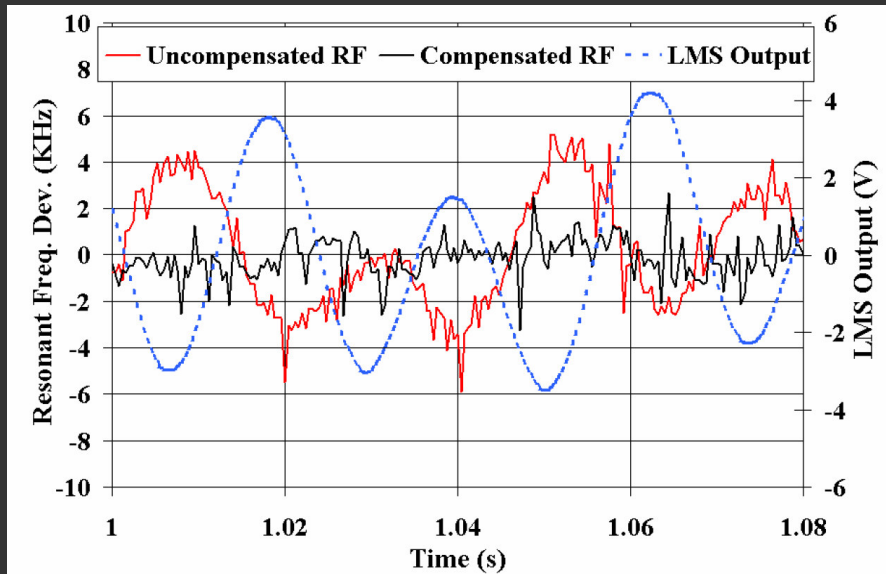

Work at MSU (RIA)

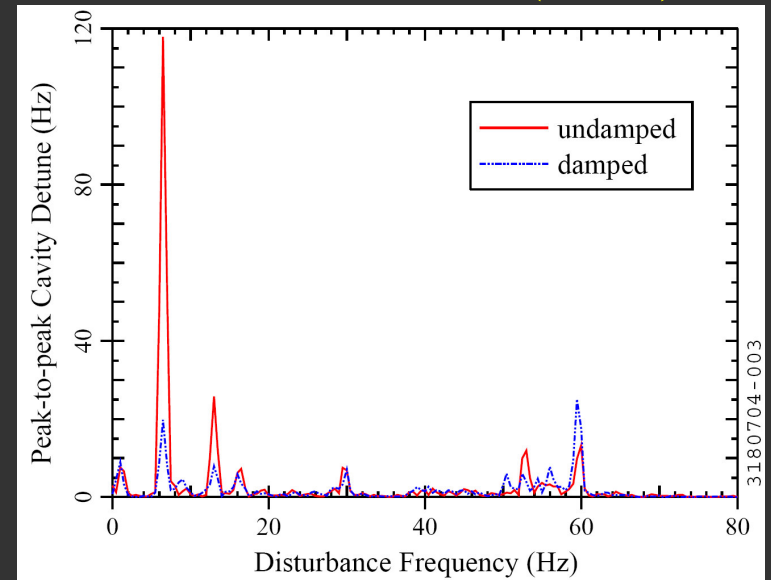



- **What is missing?**
 - **Need to demonstrate the control of “random” beam loading in main linac can be handled with a x00 mA beam**
 - **Need to demonstrate high beam loading control in injector**
 - **Active microphonics compensation; first steps have been done, but much more needs to be done. Has big potential!**
 - **Ultra stable reference signal distribution.**





Outlook

What does this mean?



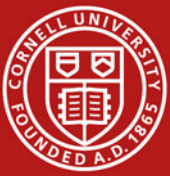

Outlook II

What does this mean?

- Could we build an x00 mA ERL linac today?

Maybe...

- Can we build an x00 mA ERL linac in a few years?

Sure!

Many ERL R&D opportunities exist/are coming up:

- JLAB IR ERL
- JLAB 100 mA / 1 A ERL
- BNL ERL prototype
- Daresbury ERL prototype
- Cornell ERL prototype

All we need is to work together and put the existing pieces together...that's why we are here, after all.



A sunset scene over the ocean. The sun is a bright yellow circle in the center, with its light reflecting on the water. A sailboat is silhouetted against the sun. The sky is a gradient of orange and yellow.

SRF 2005

ERL 2005

Stay tuned!

Thank you to all of you...

You did the work I showed!