

X-ray Detectors: State-of-the-art & Future Possibilities

Sol M. Gruner
Physics Dept. & Cornell High Energy Synchrotron Source (CHESS)
Cornell University
Ithaca, NY 14853
smg26@cornell.edu

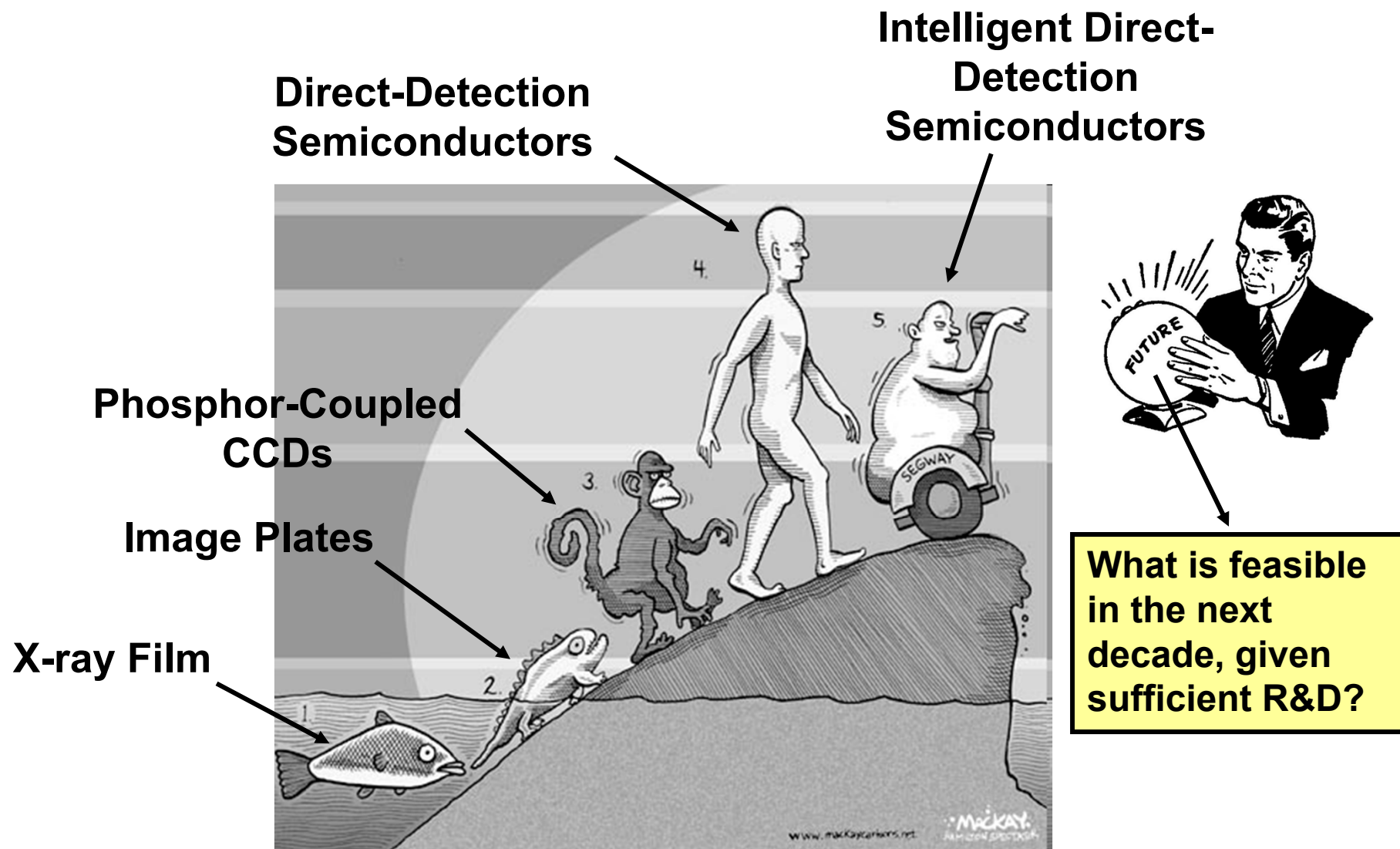

simplified view of the
Evolution of Imaging Synchrotron X-ray Detectors



Less prevalent imaging detectors are omitted for sake of time.



Limitations arise from fundamental physical properties of detector parts

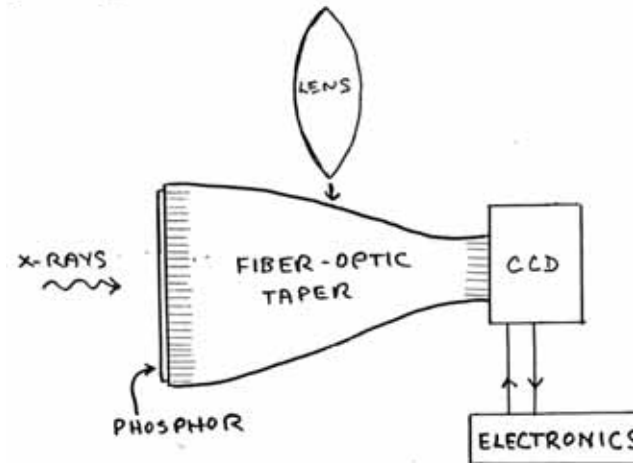

Phosphor: settled powder or single crystal garnet

- Speed (msec to μ s) vs. efficiency, even for single snapshots
- Resolution vs. efficiency

Light relay system: fiber optics bundle or lens

- Fiber optics limit resolution to several microns
- Lenses have higher resolution, but limit dynamic range

CCD

- Serial nature of readout limits frame time

Normal depletion thickness is only a few microns

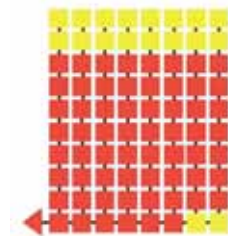

Direct Detection in Silicon

- Si is a superb x-ray to electrical signal converter.
- @ 10 keV, radius of e-h cloud ~ 1 micron.
- Number e-h pairs, N_{eh} : $E_{x-ray} / 3.64 \text{ eV}$
- $\sigma(N_{eh}) / N_{eh} = \sqrt{F / N_{eh}}$, where $F \equiv$ Fano Factor = 0.1.
- Hence, 10 keV yields $N_{eh} = 2740 \pm 20$.

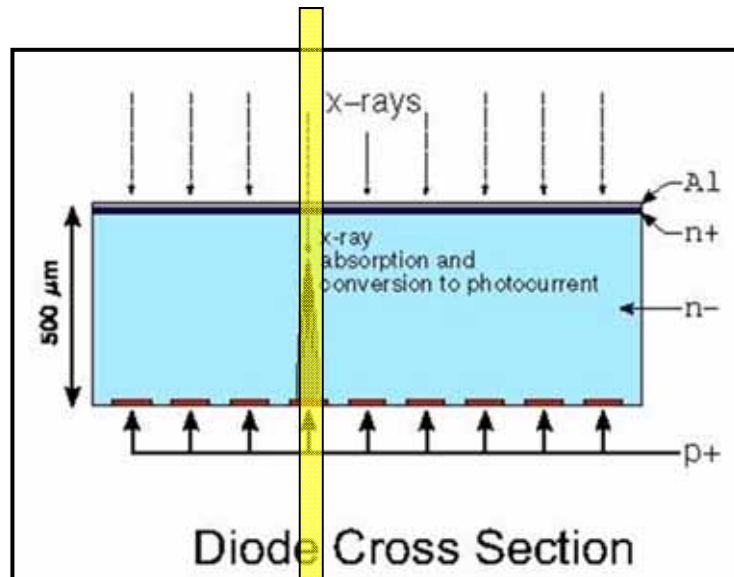

→ ← 20 – 40 μm, ~20 ns

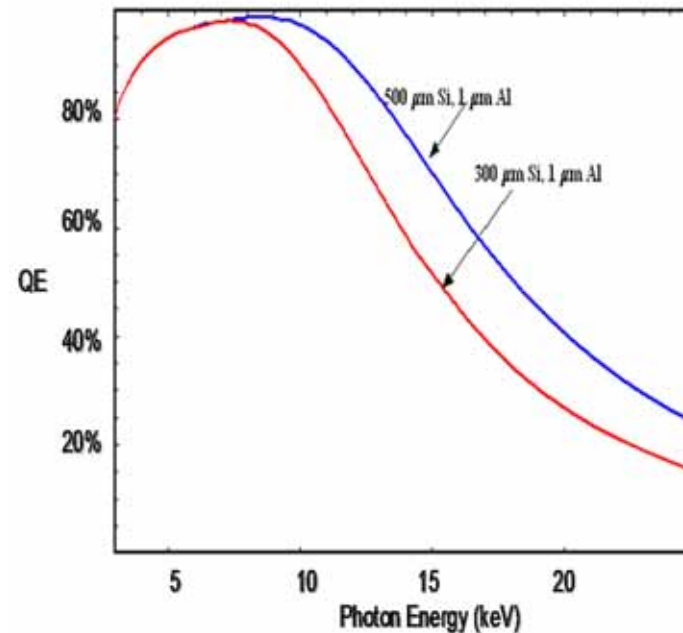



CCD output configuration

- CCDs are intrinsically slow
 - Single output CCD
 - Column parallel CCD
 - Almost column parallel CCD
- LBNL FCCD
 - Multiple outputs (ex. 48 per side)
 - Faster outputs (ex. 1MHz)
 - 200 fps

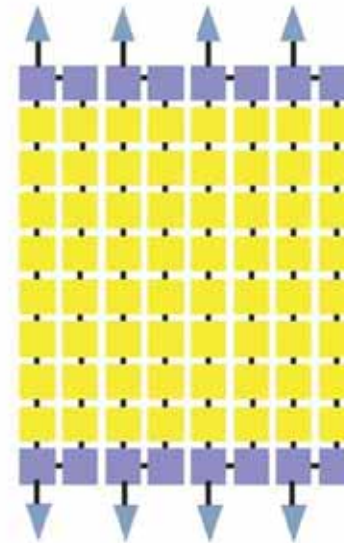

September 21, 2010

D. Doering, LBNL @ SRI 2010 Detector workshop

11





(New) R&D CCD – 1k Frame Store

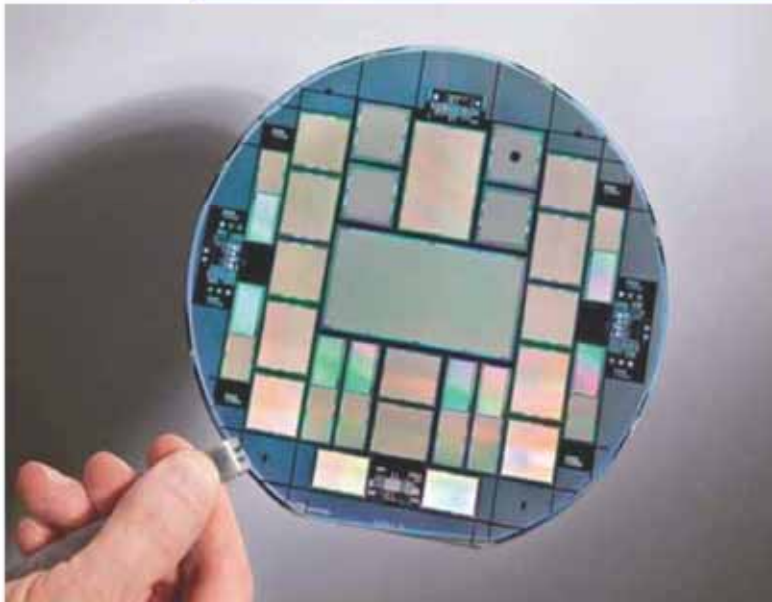

- 30 x 30 μm pixel
- 1920x960 pixels (8 times the area of cFCCD)
- Thick 200-650 μm
- 200fps
- Data volume \sim 400MB/s (HD 250GB \rightarrow \sim 10 min)

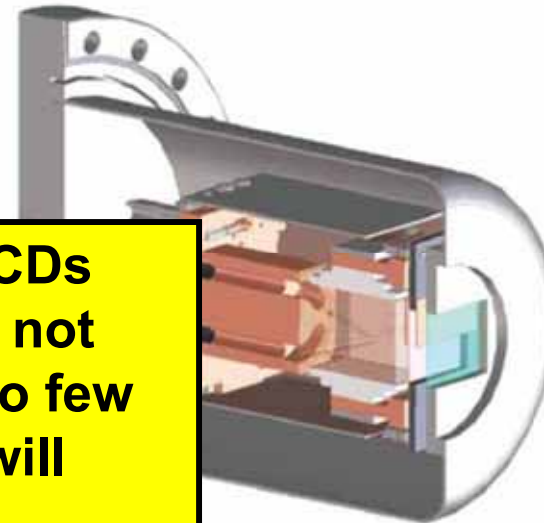

A number of direct x-ray conversion CCDs will soon be available, though perhaps not commercially. Well depths are limited to few hundred x-rays/pix and frame speeds will likely eventually top out at \sim 1KHz.

September 21, 2010

D. Doering, LBNL @ SRI 2010 Detector workshop

35



Semiconductors

Physical characteristics of the semiconductors

Semi-conductor	ρ [g/cm ³]	Z	E_{gap} [eV]	ϵ [eV]	T_{working} [K]	K-edge [keV]	ρ_c [Ω cm]	$\mu_{e,h} \tau_{e,h}$ [cm ² /V]
Si	2.33	14	1.12	3.6 [1]	300	1.8	$\approx 10^3$	0.42, 0.22
Ge	5.33	32	0.67	2.9 [3]	77	11.1	$\approx 10^2$	0.72, 0.84
GaSe	4.55	31, 34	2.03	4.5 [4]	300	10.3, 12.6		$10^{-7}, 10^{-7}$ $1.5 \times 10^{-6}, 2.5 \times 10^{-6}$
InP	4.78	49, 15	1.30	4.2 [6]	300	27.9, 2.1	$\approx 10^7$	$4.8 \times 10^{-6}, \leq 10^{-7}$
CdS	4.84	48, 16	2.60	7.3 [15]	300	26.7, 2.4		
GaAs	5.32	31, 33	1.43	4.3 [3]	300	10.3, 11.8	$\approx 10^7$	$8.6 \times 10^{-6}, 4.0 \times 10^{-7}$ $8.6 \times 10^{-5}, 4.0 \times 10^{-6}$
InSb	5.77	49, 51	0.20	0.6 [15]	4	27.9, 30.4		$10^{-5}, 7.5 \times 10^{-6}$
CdSe	5.80	48, 34	1.73	5.5 ^a	300	26.7, 12.6		$2.0 \times 10^{-5}, 1.5 \times 10^{-6}$
CdTe	6.20	48, 52	1.44	4.7 [3]	300	26.7, 31.8	$\approx 10^9$	$2.0 \times 10^{-3}, 4.0 \times 10^{-4}$
PbI ₂	6.20	82, 53	2.55	7.7 ^a	300	88.0, 33.2	$> 10^{13}$	$8.0 \times 10^{-6}, 2.0 \times 10^{-7}$
HgI ₂	6.40	80, 53	2.13	4.2 [7]	300	83.1, 33.2	10^{13}	$10^{-4}, 10^{-5}$
TlBr	7.56	81, 35	2.68	6.5 [18]	300	85.5, 13.5	$\approx 10^{12}$	$1.6 \times 10^{-5}, 1.5 \times 10^{-6}$

From Bencivelli et al., Nucl. Instr. Meth. Phys. Res. A310 (1991) 210-214

On a decade time scale x-ray sensors of “exotic” semiconductors are feasible, though probably only as bump-bonded sensors. High atomic number materials can extend detection to very hard x-rays.



Basic Pixel Array Detector (PAD)

Diode Detection Layer

- Fully depleted, high resistivity
- Direct x-ray conversion in Si

Connecting Bumps

- Solder, 1 per pixel

CMOS Layer

- Signal processing
- Signal storage & output

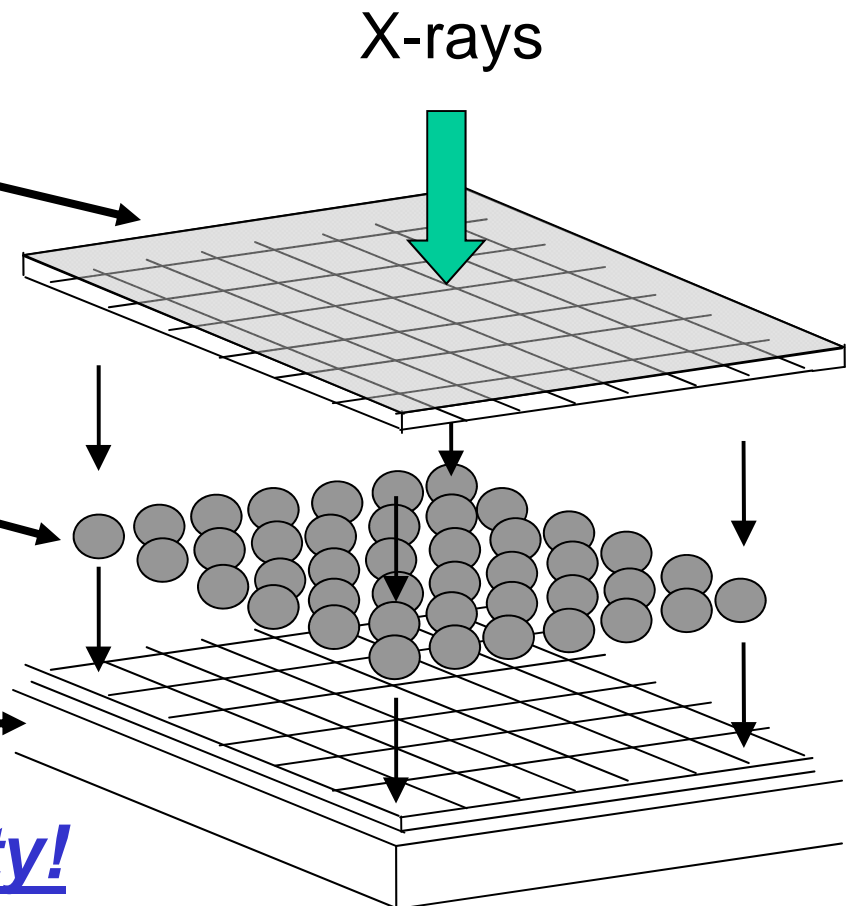

Gives enormous flexibility!



PADs come in two varieties

Photon counting PADs

- Front ends count each x-ray individually. (PILATUS, Medipix)
- Drawback for high-speed imaging: Count-rate limited by electronics to $\sim 10^6$ - 10^7 x-rays/pix/sec.



Integrating PADs

- Use an integrating front-end to avoid the count-rate bottleneck.
- Capable of handling enormous count-rate.
- Existing variants include LCLS, ADSC, Acrorad

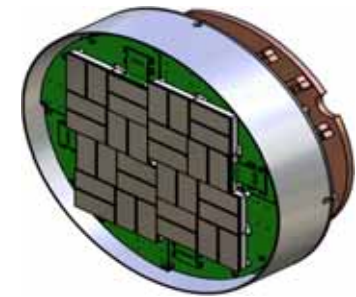

Cornell-SLAC LCLS

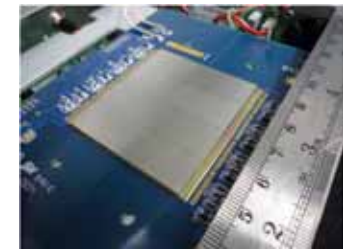

Acrorad CdTe



simplified view of the

Evolution of Imaging Synchrotron X-ray Detectors

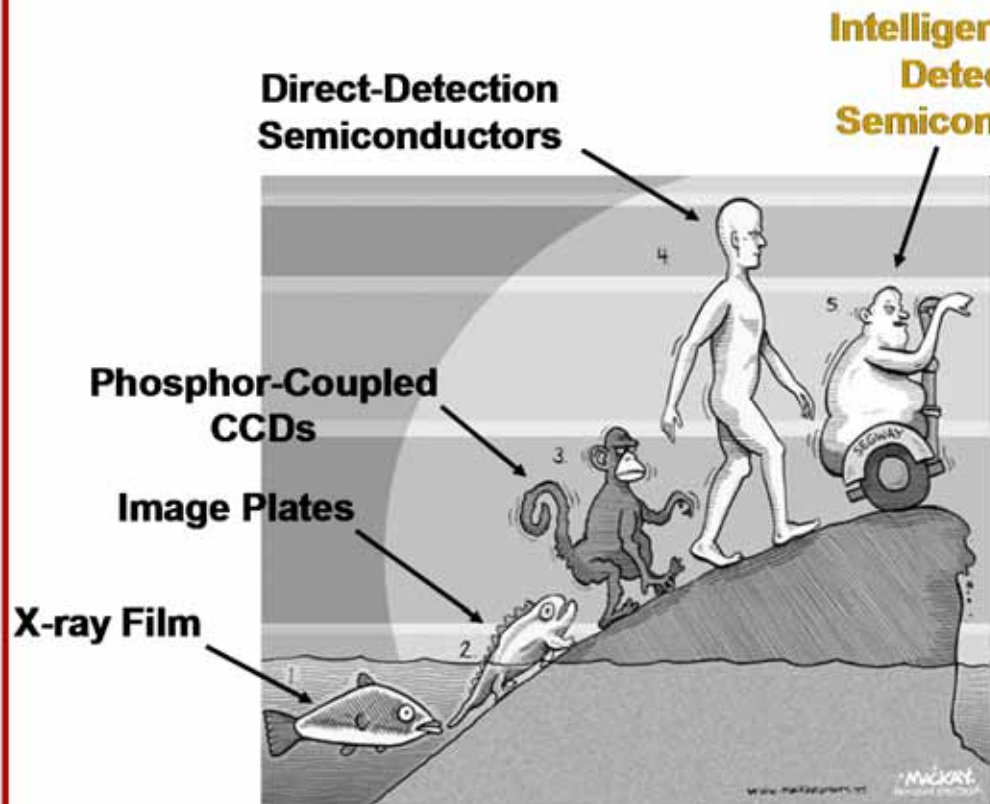

What is feasible in the next decade, given sufficient R&D?

Consider:

- Pixel size & complexity
- Spatial resolution
- Time resolution
- Analog dynamic range
- Energy resolution



simplified view of the

Evolution of Imaging Synchrotron X-ray Detectors

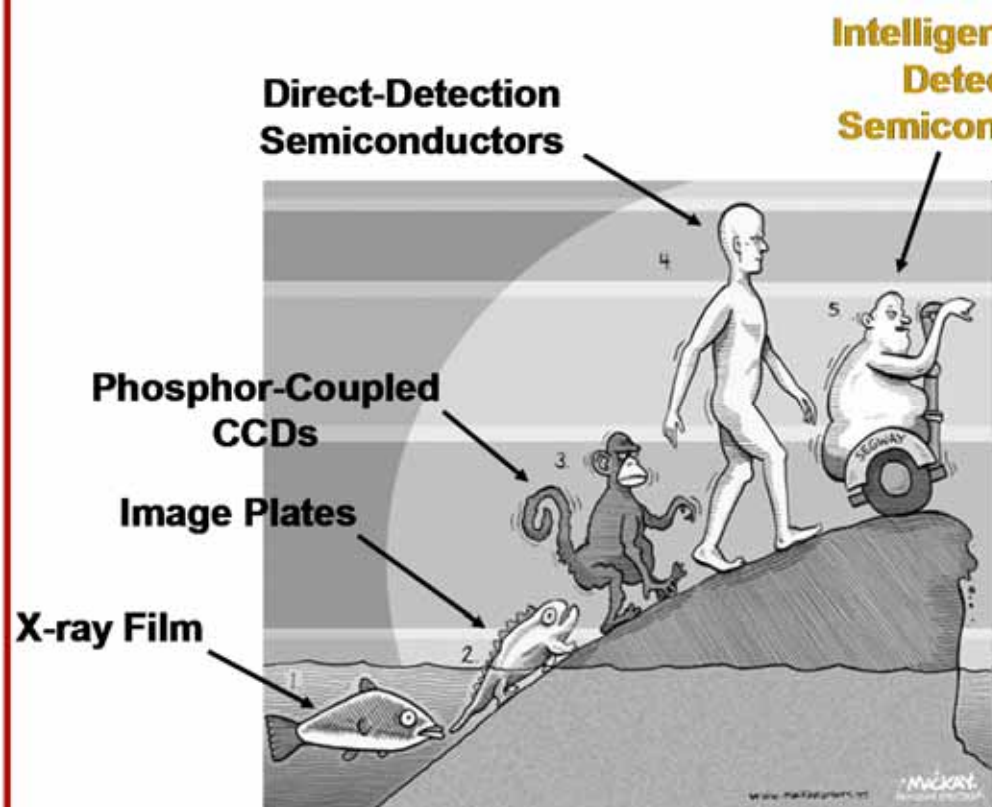

What is feasible in the next decade, given sufficient R&D?

Consider:

- Pixel size & complexity
- Spatial resolution
- Time resolution
- Analog dynamic range
- Energy resolution



KECK PAD	
Parameter	Target Value
Noise	< 0.5 x-ray/pixel/accumulation
Minimum exposure time	<150 ns for 12-bit imaging
Capacitor well depth	2000 – 4000 x-rays
Nonlinearity (% full well)	< 0.2%
Diode conversion layer	500 μm thick Si
Number of capacitor wells/pix	8
Full chip frame time	1 msec/frame, e.g., 8 msec for 8 capacitors
Radiation lifetime	> 50 Mrad at detector face @ 8 keV
Pixel size	150 μm on a side, or 128 x 128 pixels per IC
Detector chip format	2 x 4 chips = 256 x 512 pixels

Complexity at the level of 200 – 300 transistors/pixel. 0.25 μm process. Pixel sizes of 110 & 150 μm across.

LCLS PAD

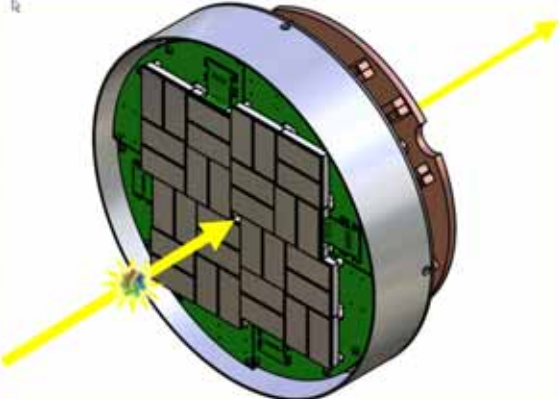
Mixed-Mode PAD (ADSC Collaboration)

PAD Tile Format	128 x 128 pixels
Pixel Size	150 μm x 150 μm
Frame Rate	Up to 1,000 Hz
Read Noise	0.3 X-ray [12 keV] / pix
Well Capacity	2.6×10^7 X-ray [12 keV]/pix/frame



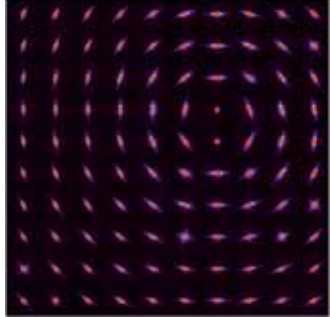

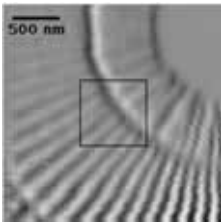
3D-ICs based on Silicon-on-Insulator (SOI) Wafers

“...Small prototypes of VIPs are extendable to sizes of 1024×1024 pixels, bearing the actual needs of the application. **The top tier** contains a gated charge integrator, a single ended AC-coupled offset corrected discriminator with capacitively injected threshold, an analog memory for reference sample, an analog memory for post discriminator sample, a pulse generator for time stamping lock and hit information lock, a receiving part of test-charge injection capacitance and a bonding pad to the detector. **The intermediate tier** features an analog memory cell for time stamping (distributed voltage ramp), a 7-bit SRAM-like digital time stamping memory with output enable control to read on the same lines on which time ticks in Gray code are distributed. The **bottom tier** hosts the sparsification system: token propagation logic, wiredOR line access logic for X-line/Y-line of a hit pixel address generator, test-charge injection logic and a peripheral serialization and output part.”

This is ~200 transistor level of complexity in 20 um pixel.

From: Deptuch et al, FERMILAB-CONF-10-401-PPD

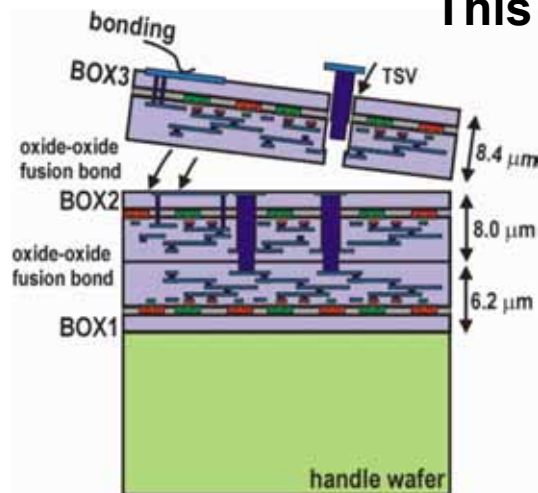

On a decade time scale pixels with reasonable levels of complexity and 10 – 20um pixel sizes are feasible.

Deptuch et al, FERMILAB-PUB-10-314-ppd



Cornell University
Physics Department & CHES

simplified view of the

Evolution of Imaging Synchrotron X-ray Detectors

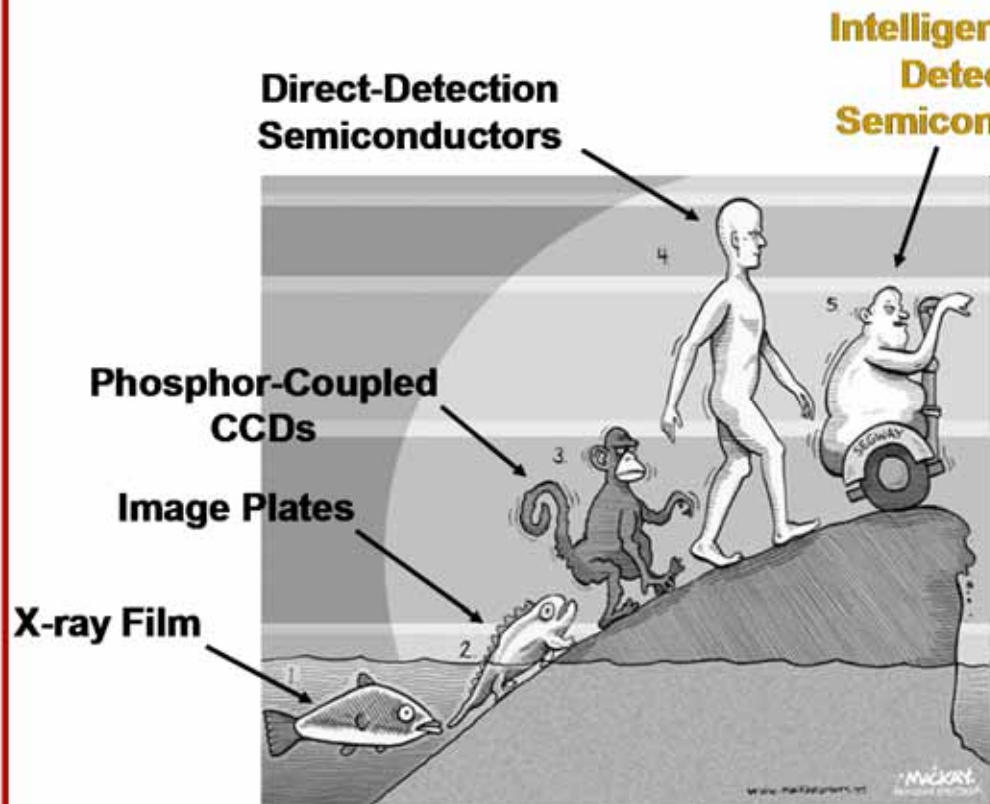

What is feasible in the next decade, given sufficient R&D?

Consider:

- Pixel size & complexity
- **Spatial resolution**
- Time resolution
- Analog dynamic range
- Energy resolution



High Spatial Resolution Using Doped Garnets

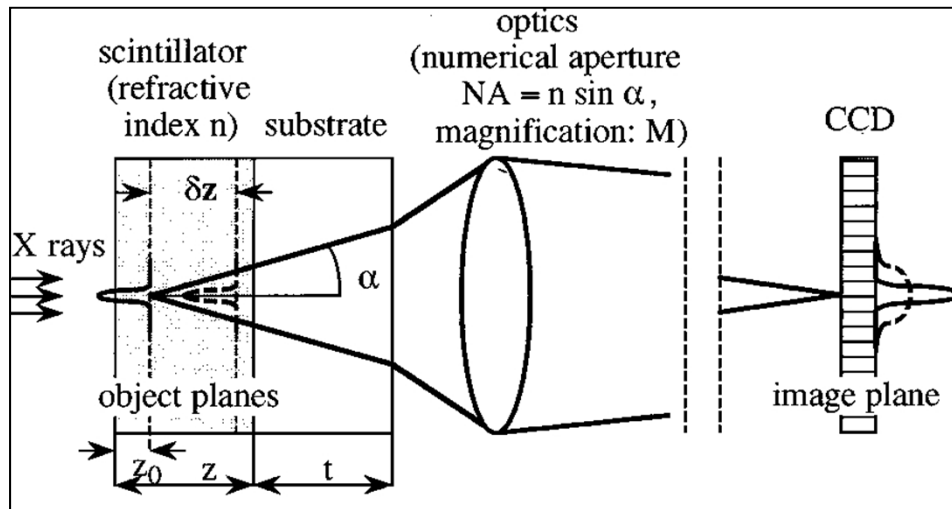

Single crystal YAG:Ce and GGG:Eu screens with doped layers microns thick are commercially available (e.g., ESRF; laser vendors).

Present spatial resolutions of $\sim 0.7\mu\text{m}$ are available with reasonable efficiencies. The wavelength of light and photoelectron emission will likely limit this to small digit improvements, at best.



simplified view of the

Evolution of Imaging Synchrotron X-ray Detectors

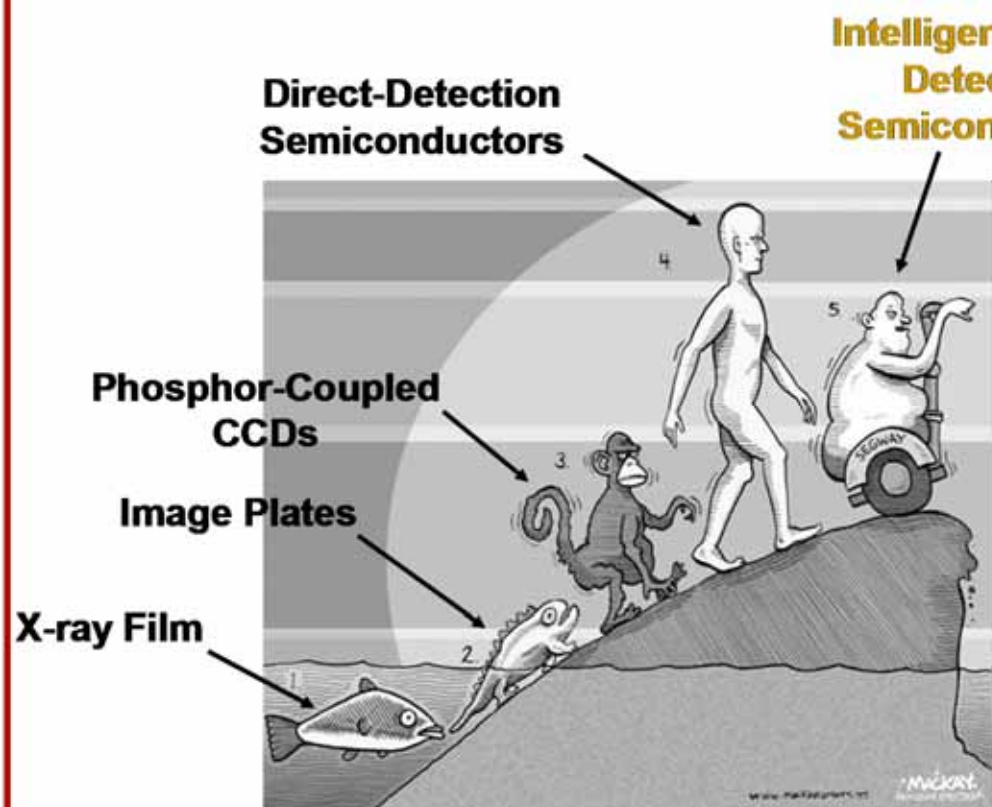

What is feasible in the next decade, given sufficient R&D?

Consider:

- Pixel size & complexity
- Spatial resolution
- **Time resolution**
- **Analog dynamic range**
- Energy resolution



Time Resolution

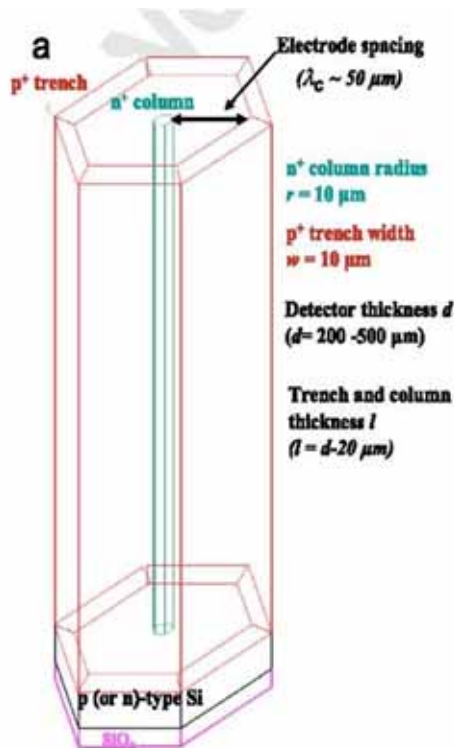
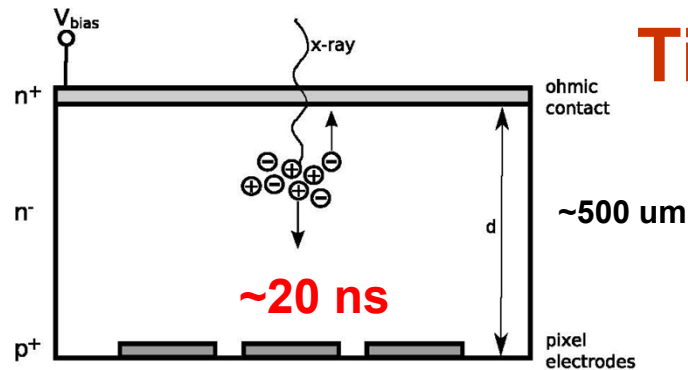

few ns
using Si

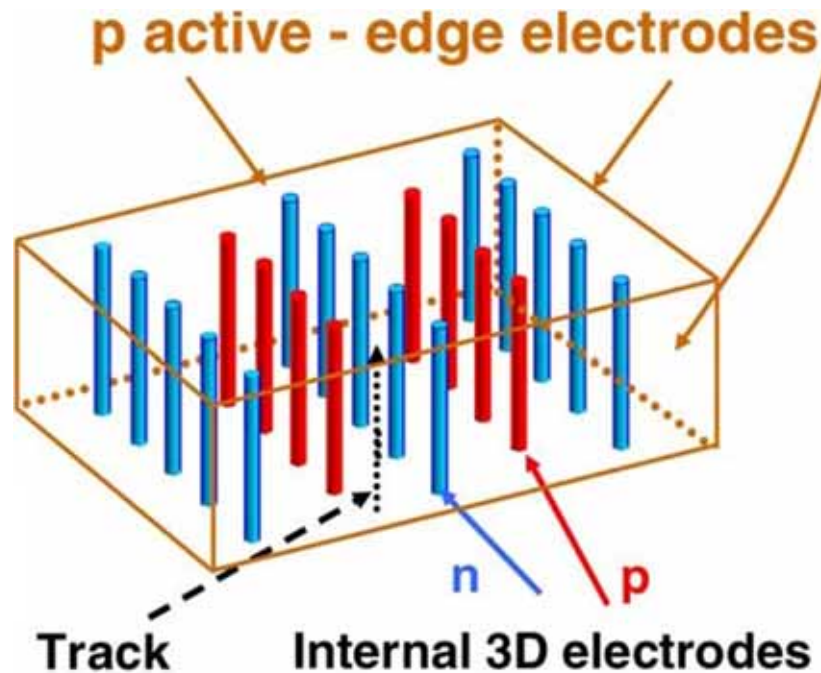

Parker et al., IEEE Trans. Nucl. Sci. 58 (2011) 404.

3D silicon sensors capable of a few ns response are in advanced R&D. On a decade time scale, use of “exotic” semiconductors and few hundred ps response may be feasible.

Z. Li, Nucl. Instr. and Meth. A (2011), doi:10.1016/j.nima.2011.05.003



Cornell University
Physics Department & CHESS

Time Resolution: Use Nanopillars

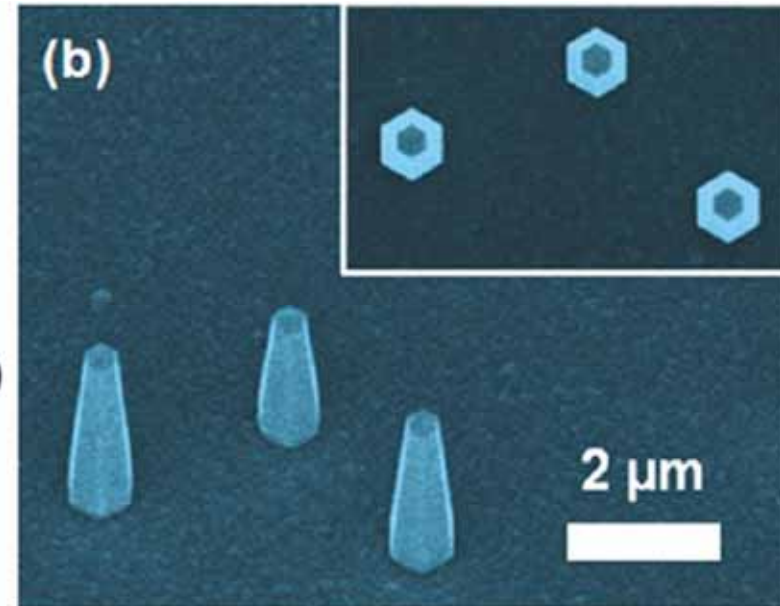
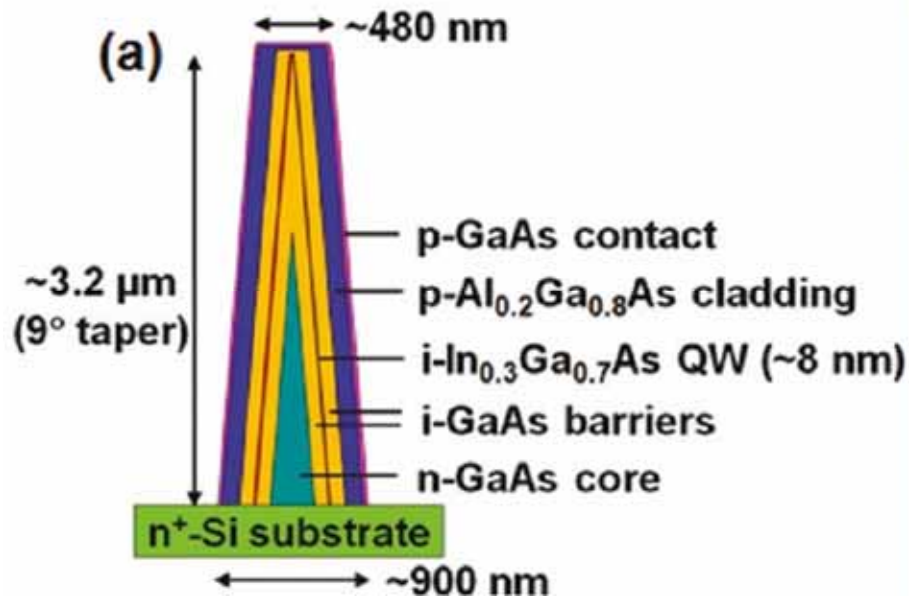

From: Chuang et al., NANO Letters 11 (2011) 385

This is an LED, but they also report on Avalanche Photodiodes (APD)

A dense forest of nanopillar APDs are in principle capable of few ps response. With sufficient R&D fill factors of $\sim 25\%$ may become feasible. Readout electronics then become limiting.



Frame Time

Considerations:

- Front-end amplifier settling time.
- Time to transfer data to off-ASIC digital memory. **Parallelize!**

KECK PAD	
Parameter	Target Value
Noise	< 0.5 x-ray/pixel/accumulation
Minimum exposure time	<150 ns for 12-bit imaging
Capacitor well depth	2000 – 4000 x-rays
Nonlinearity (% full well)	< 0.2%
Diode conversion layer	500 μm thick Si
Number of capacitor wells/pix	8
Full chip frame time	1 msec/frame, e.g., 8 msec for 8 capacitors
Radiation lifetime	> 50 Mrad at detector face @ 8 keV
Pixel size	150 μm on a side, or 128 x 128 pixels per IC
Detector chip format	2 x 4 chips = 256 x 512 pixels
Dark current	2 x-rays/pix/sec

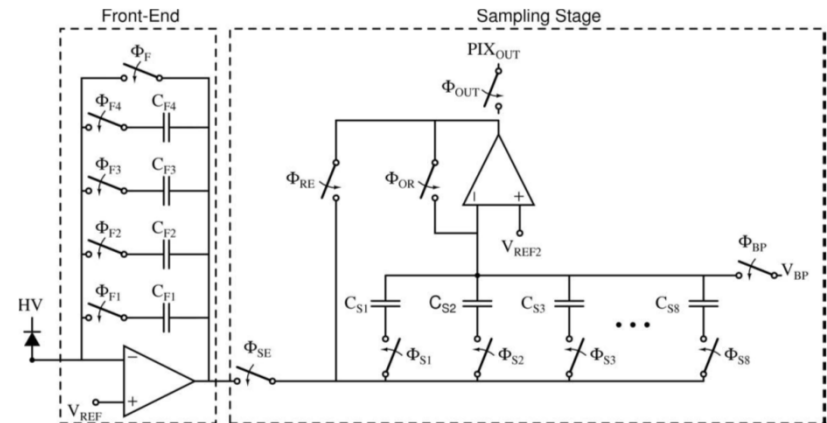

Koerner & Gruner, J. Synchro. Rad. 18 (2011) 157.

< 150 ns for 12 bit settling shown.
Equivalent to ~4000 8 keV x-rays.
Faster for fewer bits. A few bits in
10's of ns should be feasible.



The Adaptive Gain Integrating Pixel Detector

Basic parameters

- 1 Megapixel detector (1k × 1k)
- 200μm × 200μm pixels
- Flat detector
- Sensor: Silicon 128 × 512 pixel tiles
- Single shot 2D-imaging
- 5MHz frame rate
- 2×10^4 photons dynamic range
- Adaptive gain switching
- Single photon sensitivity at 12keV
- Noise $\leq 200e$ (50×10^{-3} photons @ 12keV)
- Storage depth ≥ 200 images
- Analogue readout between bunch-trains

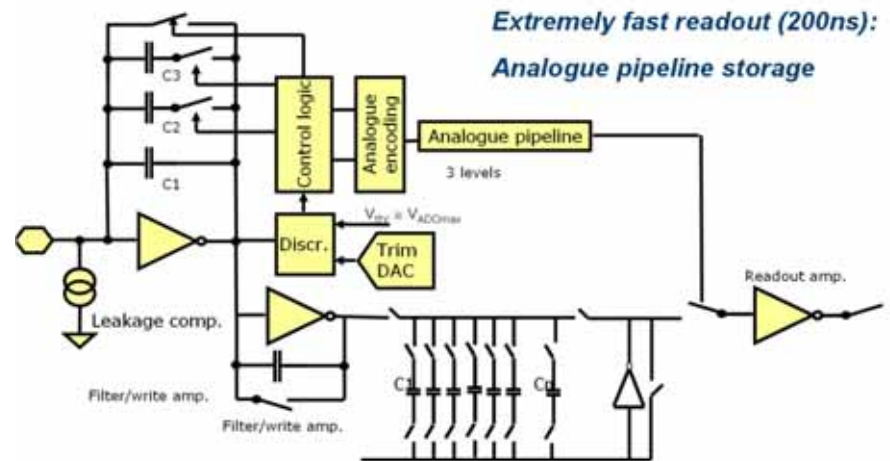
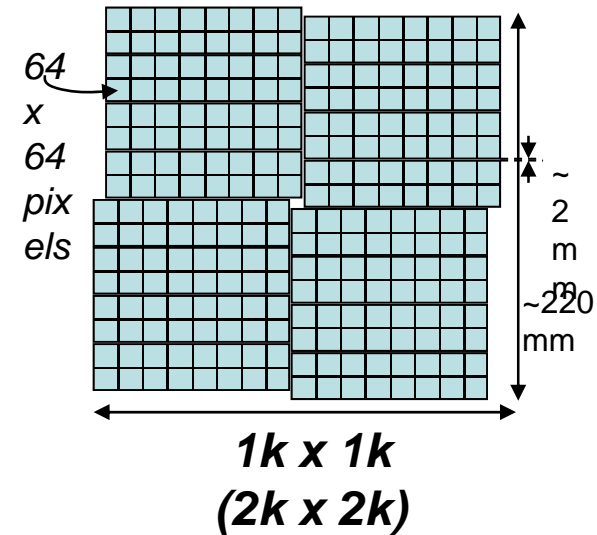
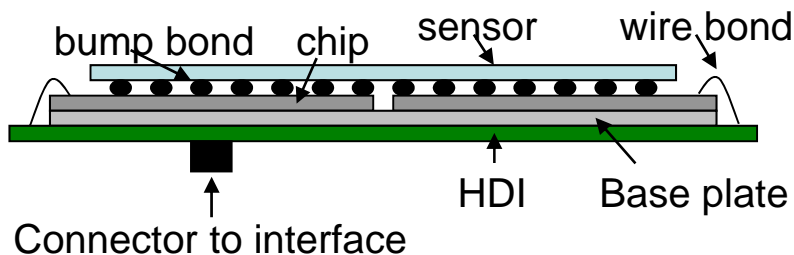

On the 10 year time scale, detectors of large format ($>10^6$ pixels), wide dynamic range ($>10^4$ 10 keV x-rays/pix/frame), frame rates of ~ 100 ns, and frame depths of hundreds of frames are likely feasible. If the dynamic range is reduced to ~ 10 's of x-rays/pix/frame, frame rates can likely fall to a few 10's of ns.



simplified view of the

Evolution of Imaging Synchrotron X-ray Detectors

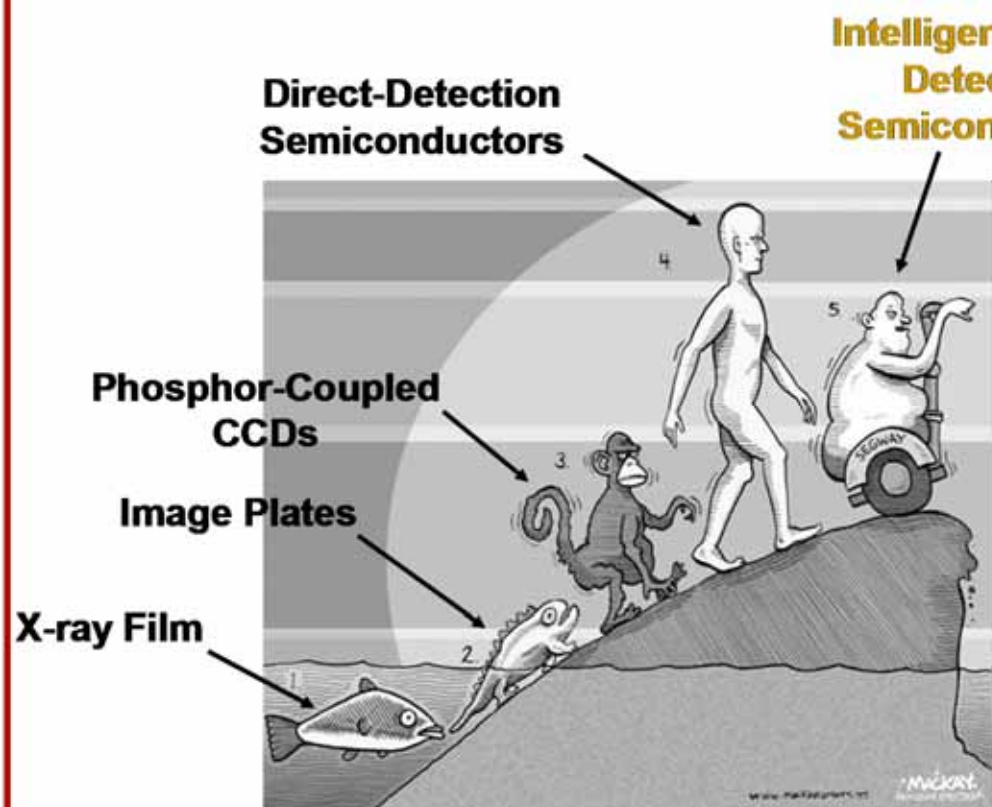

What is feasible in the next decade, given sufficient R&D?

Consider:

- Pixel size & complexity
- Spatial resolution
- Time resolution
- Analog dynamic range
- **Energy resolution**



Bolometers / Microcalorimeters

Slide from Kent Irwin of NIST, shown at SRI-2005 at ANL

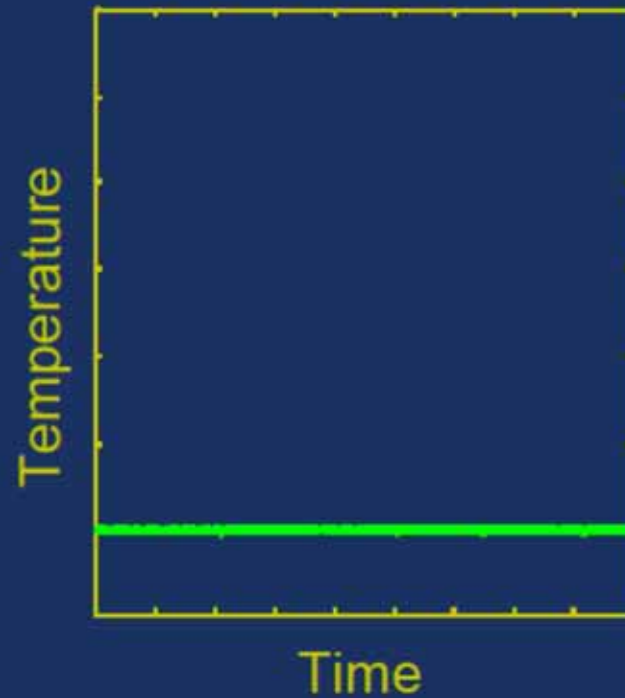
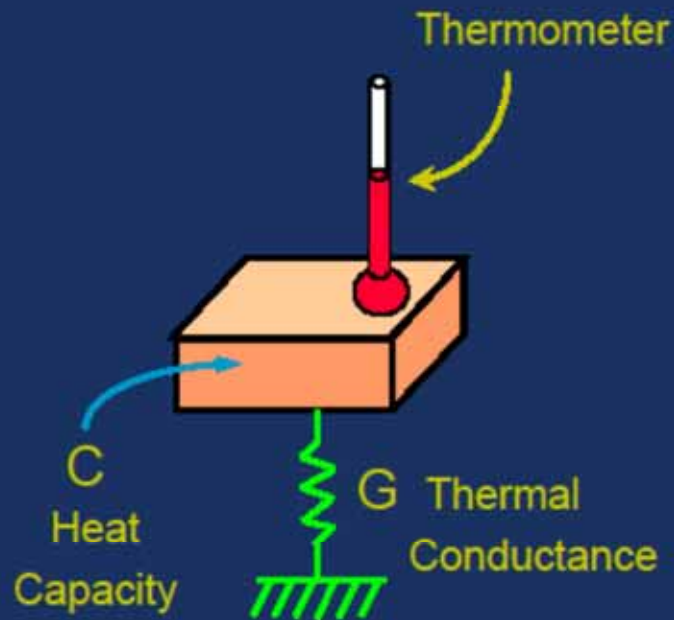

NIST National Institute of Standards and Technology • Technology Administration • U.S. Department of Commerce



Bolometers / Microcalorimeters

Slide from Kent Irwin of NIST, shown at SRI-2005 at ANL

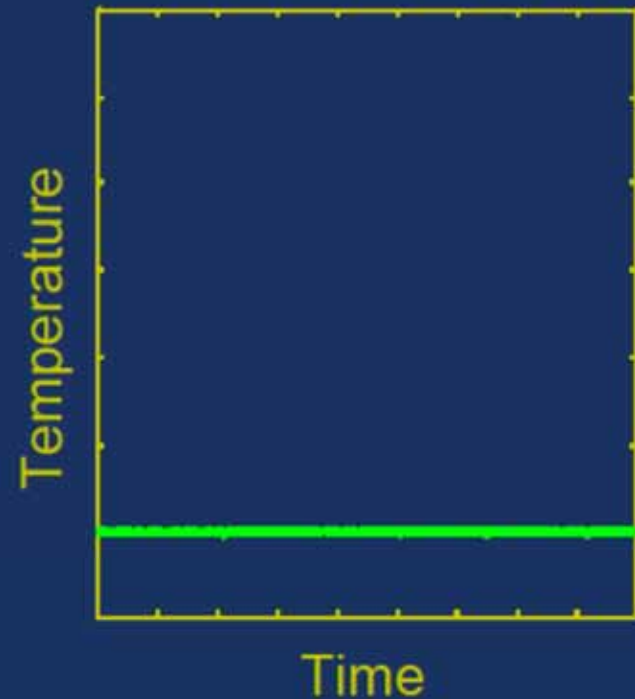
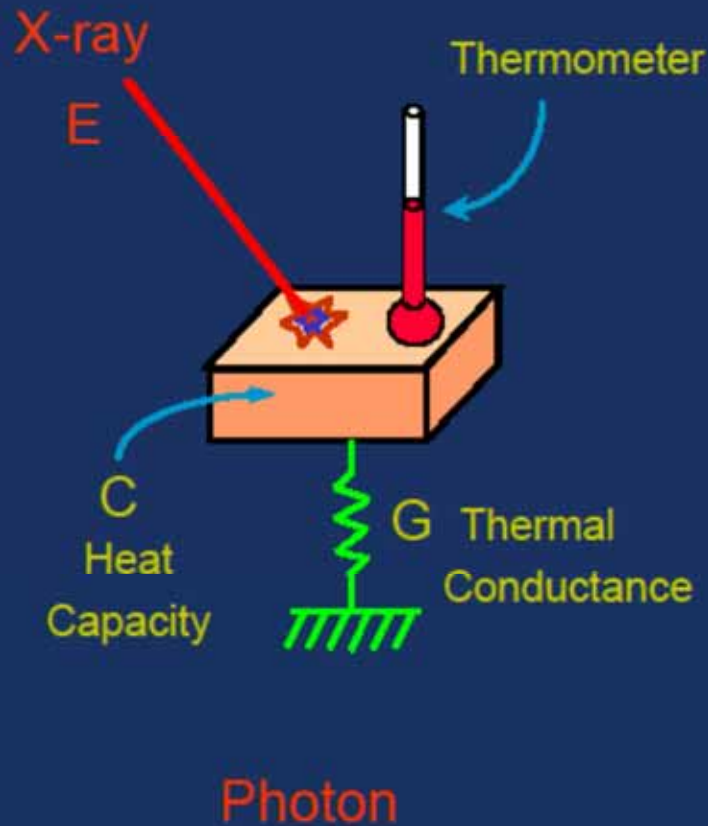

NIST

National Institute of Standards and Technology • Technology Administration • U.S. Department of Commerce



Bolometers / Microcalorimeters

Slide from Kent Irwin of NIST, shown at SRI-2005 at ANL

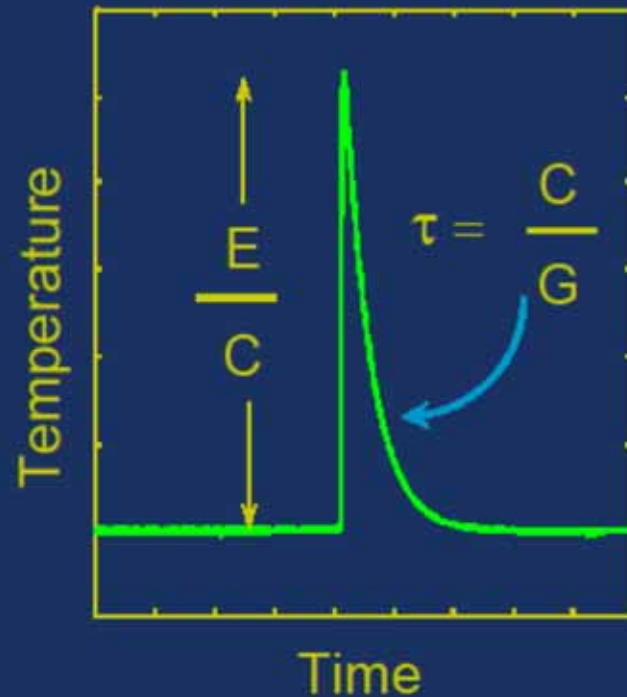
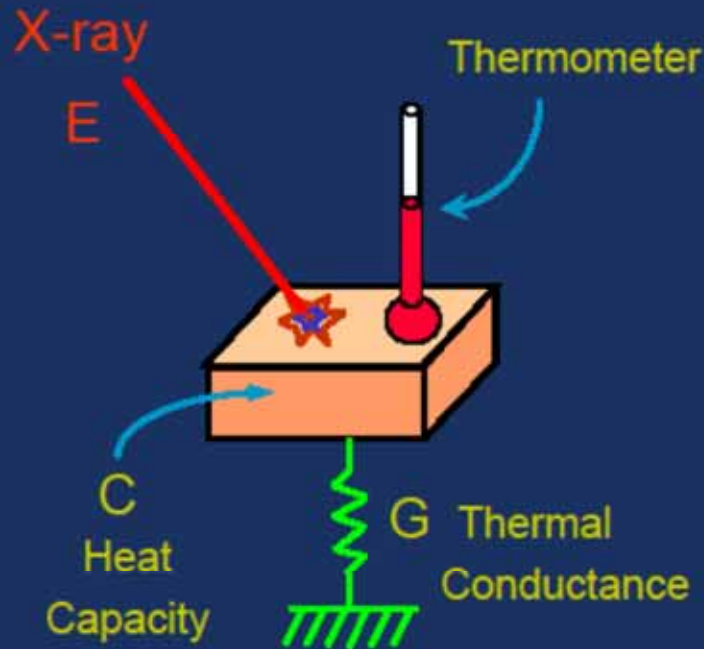

NIST

National Institute of Standards and Technology • Technology Administration • U.S. Department of Commerce



Development possible over 5-10 years

Slide from Kent Irwin of NIST, shown at SRI-2005 at ANL

All pixels 250 μm in size...

Optimization	E	ΔE_{FWHM}	array size	Array count rate	Timescale
Best resolution	0.1 – 10 keV	3 eV	32 \times 32	200 kHz	~ 3 years
Best count rate 1 keV	0.1 – 1 keV	6 eV	100 \times 100	20 MHz	~ 5 years
Best count rate 10 keV	0.1 – 10 keV	20 eV	100 \times 100	5 MHz	~ 5 years
Microwave	0.1 – 10 keV	5 eV	100,000	100 MHz	5 - 10 years

Can also make instruments for THz, IR, visible & UV, γ -ray

NIST National Institute of Standards and Technology • Technology Administration • U.S. Department of Commerce



Warnings!

1. **Difference between feasibility and reality: \$**
2. **No one detector will have all the characteristics discussed.**



Cornell PAD Group

- **Actively working on PAD projects at Cornell:**
 - Darol Chamberlain
 - Kate Green
 - Marianne Hromalik
 - Hugh Philipp
 - Mark Tate
 - Sol Gruner
- **PAD Design Collaborators:**
 - Area Detector Systems Corp.
 - SLAC
- **Past PAD Group Members:**
 - Dan Schuette
 - Alper Ercan
 - Tom Caswell
 - Matt Renzi
 - Guiseppe Rossi
 - Sandor Barna
 - Bob Wixted
 - Eric Eikenberry
 - Lucas Koerner
- **Support:**
 - U.S. Dept. of Energy
 - U.S. National Inst. Health
 - U.S. National Science Found.
 - Keck Foundation



END



The ideal detector

Should have:

- 10^9 pixels
- 1 μ m spatial resolution
- 1eV energy resolution
- 1 fs time resolution
- count rates up to 10^9 / pixel
- Efficient from 100eV out to 100keV
- **And it should be free!**

Shamelessly stolen from Peter Siddons

