



Frequency Map Calculation for the Advanced Light Source

David Robin
Advanced Light Source

work done in collaboration with

Christoph Steier (ALS), Ying Wu (Duke), Weishi Wan (ALS), Winfried Decking (DESY), James Safranek (SLAC/SSRL), Jacques Laskar (BdL), Laurent Nadolski (SOLEIL), Scott Dumas (U. Cinc.)

with help from

Alan Jackson (LBNL), Greg Portmann (SLAC/SSRL), Etienne Forest (KEK), Amor Nadji (SOLEIL), Andrei Terebilo (SLAC/SSRL)



Outline

Motivation

- Beam Lifetime
- Injection Efficiency

Single Particle Beam Dynamics in the ALS

- Importance of Periodicity
- Example of Frequency Map with Lattice Errors

Frequency Map and Particle Loss

Injection

- Superbend Example

Summary

Motivation



Performance of the Advanced Light Source (ALS) is **limited by the single particle electron beam dynamics**

- Injection efficiency
- Beam lifetime

Continue to strive for better understanding of the beam dynamics in order to

- Improve the performance of the ALS
- Accurately predict what will happen when the ALS is upgraded to include
 - Superbends, narrow gap insertion devices, elliptically polarizing undulators, femtoslicing modifications, ...

Dynamics of the ALS



The ALS is an interesting machine for studying the particle beam dynamics:

1. Simple → Simple Magnetic Lattice
2. Very Nonlinear

In terms of single particle beam dynamics, the ALS is one of the most extensively studied storage rings

1. Theoretical investigations of the ALS began in the mid 1980s (Nishimura, Forest, Ruth, Bengtsson, ...)
2. The ALS was used as the first example of frequency map analysis applied to accelerators (Laskar and Dumas in 1993)

Dynamics in the ALS: Lattice

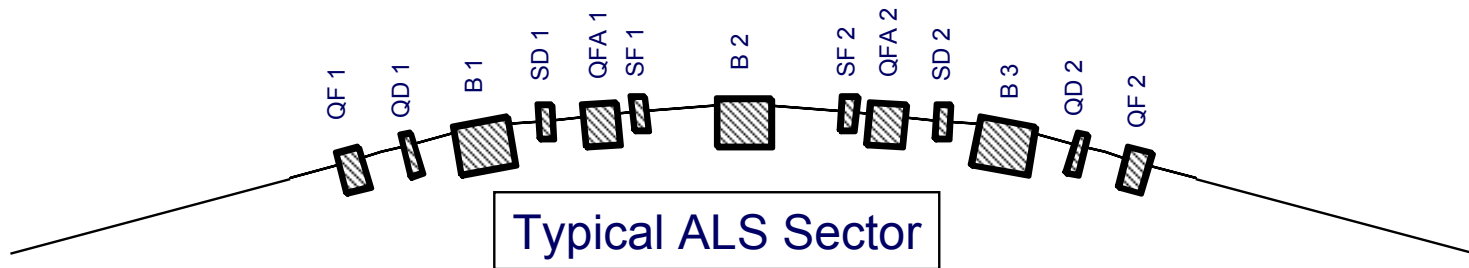

ALS consists of 12 sectors

- 12-fold periodicity → *Suppression of resonances*

$$mv_x + nv_y = 12 \times q$$

where m , n , and q , are integers

Resonance Excitation



Resonances can lead to irregular and chaotic behavior for the orbits of particles which eventually will get lost by diffusion in the outer parts of the beam.

Rule of thumb → Avoid low order resonances

Benefits of Periodicity



Tune plane - resonances up to 5th order

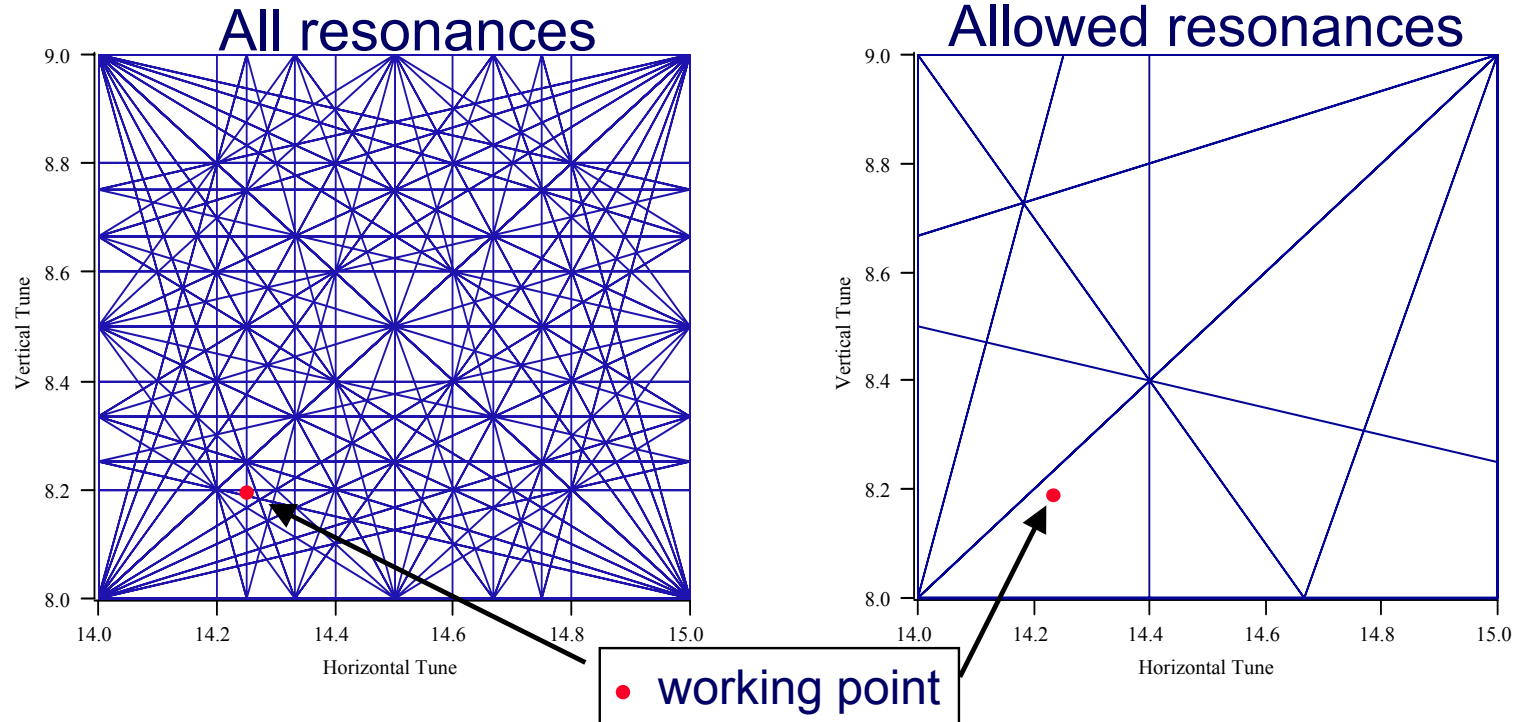

Unfortunately there is no simple way to forecast the real strength of a resonances without a realistic model of the ring and a tracking code.

ALS : Ideal Lattice versus Calibrated Model

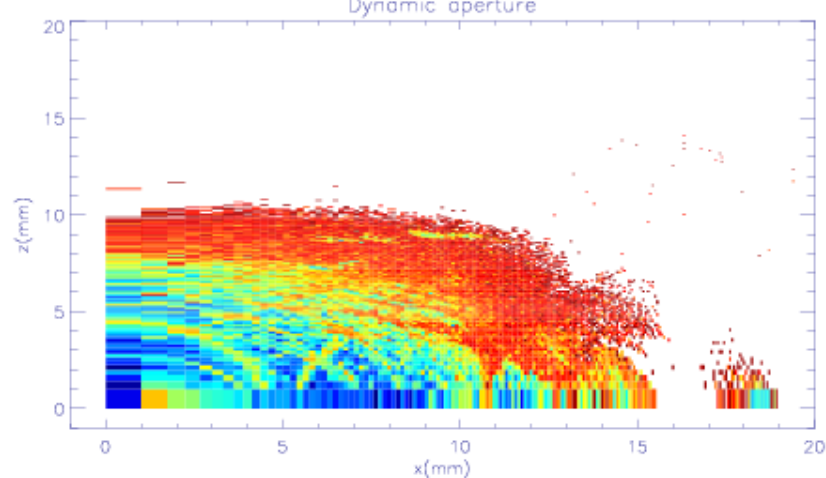
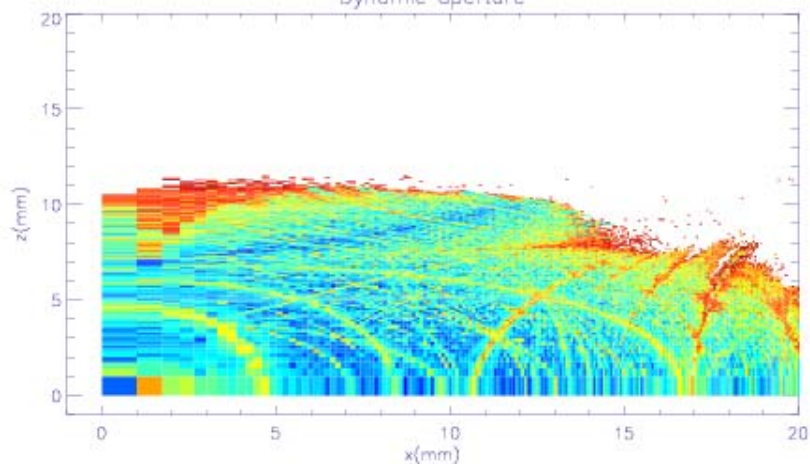
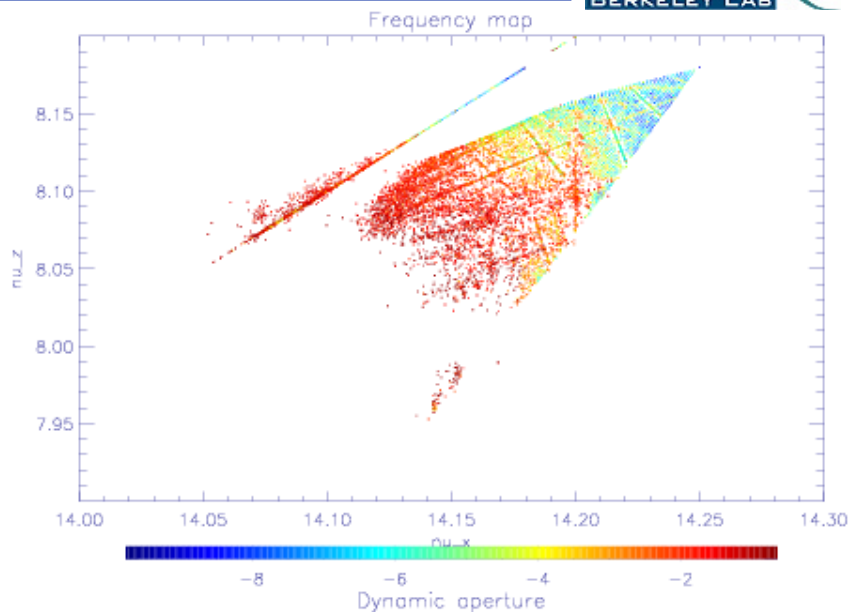
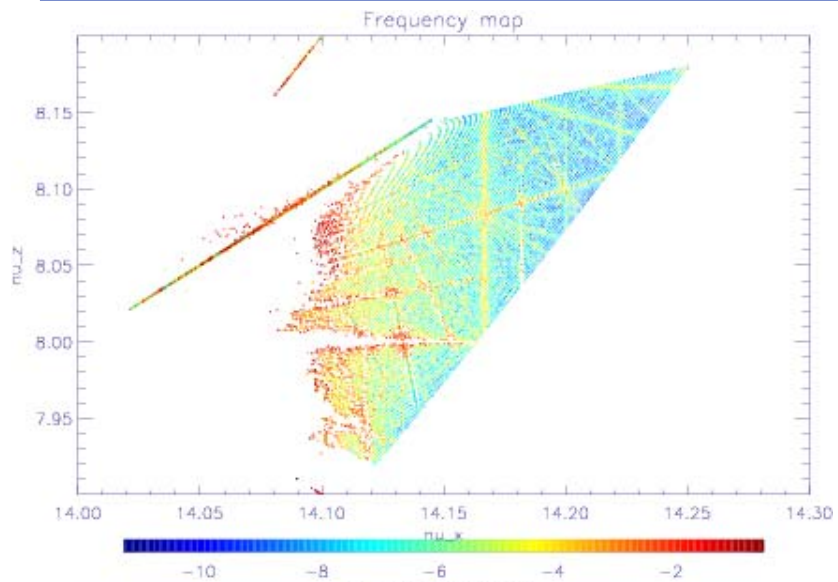



Ideal versus Calibrated Model

Introducing linear errors fundamentally changes the beam dynamics

Ideal ring

- The dynamic aperture is large
- Small chaotic zone at large amplitudes
- Particle loss is fast
- Particle loss is due to high order resonances

Ring with calibrated linear errors

- Dynamic aperture is smaller
- Large chaotic zone at large amplitudes
- Particle loss is slow
- Particle loss is due to lower order unallowed resonances



Ideal versus Calibrated Model

Introducing linear errors fundamentally changes the beam dynamics

Ideal ring

- The dynamic aperture is large
- Small chaotic zone at large amplitudes
- Particle loss is fast
- Particle loss is due to high order resonances

Ring with calibrated linear errors

- Dynamic aperture is smaller
- Large chaotic zone at large amplitudes
- Particle loss is slow
- Particle loss is due to lower order unallowed resonances

Vertical orbit diffusion – On-energy example

Particle are **lost in the vertical plane**

- **via nonlinear coupling and diffusion of the trajectory.**

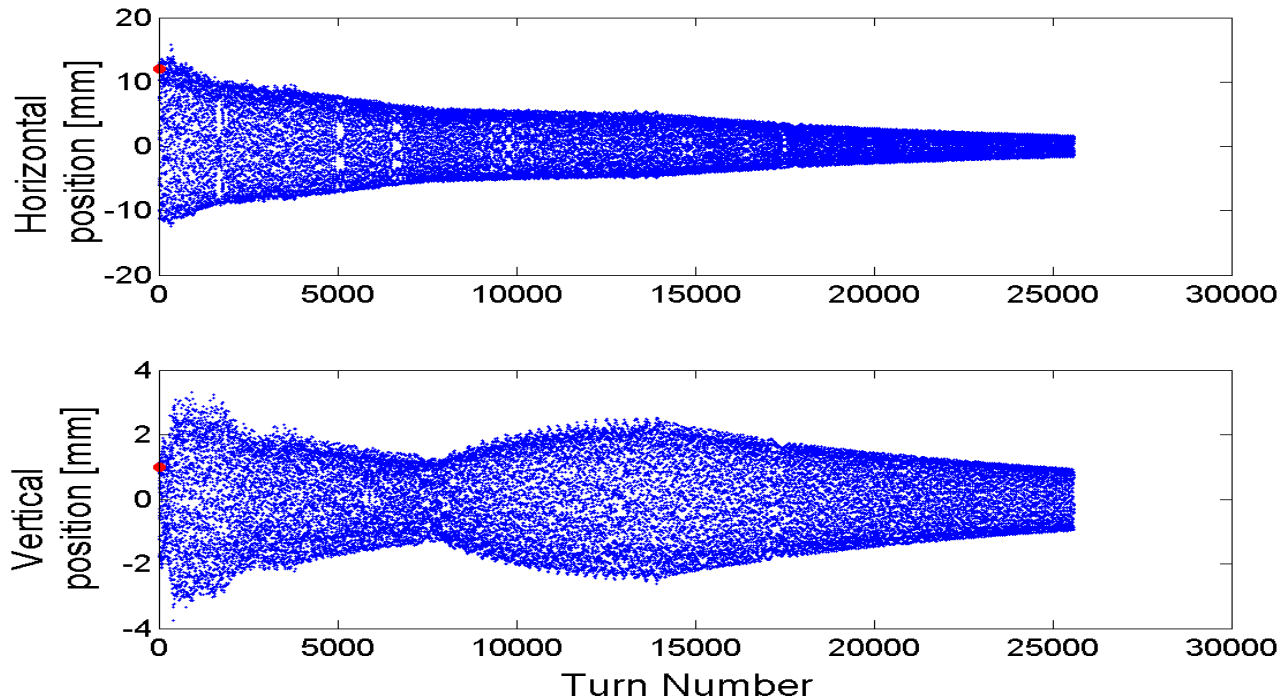

Example : Particle launched at 12 mm horizontally and 1 mm vertically and tracked with damping and synchrotron oscillations.

Frequency Map Analysis



Frequency Space

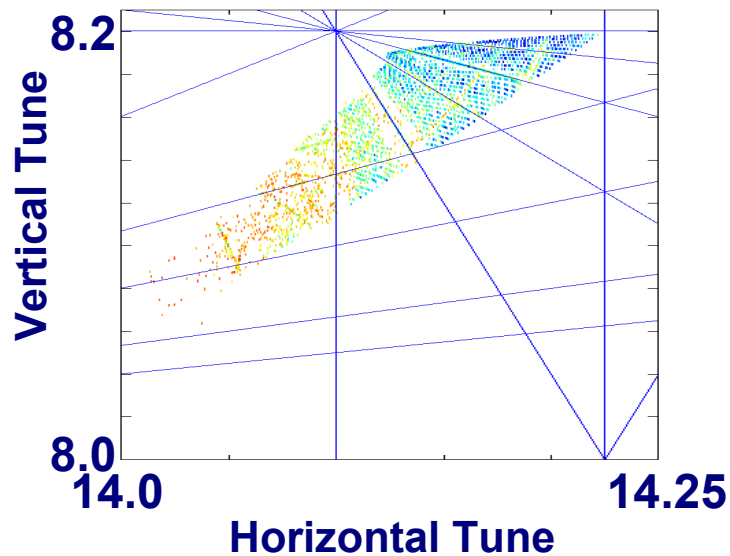

Amplitude Space

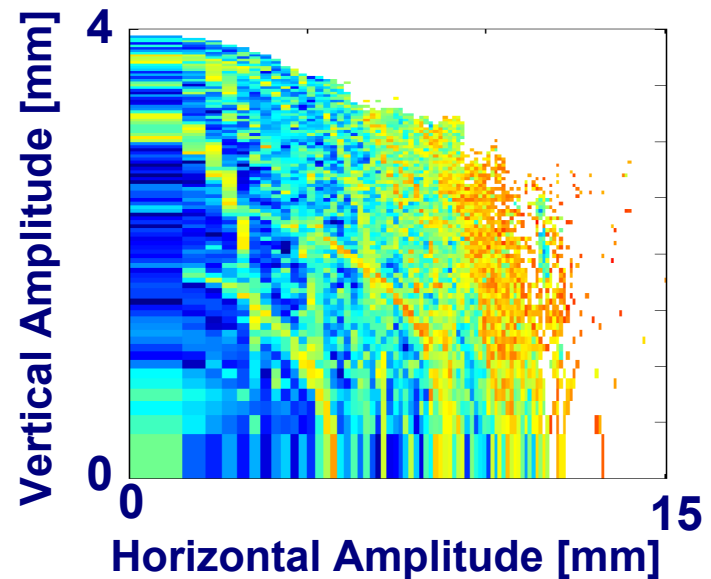

Frequency Map Analysis



Frequency Space

working point

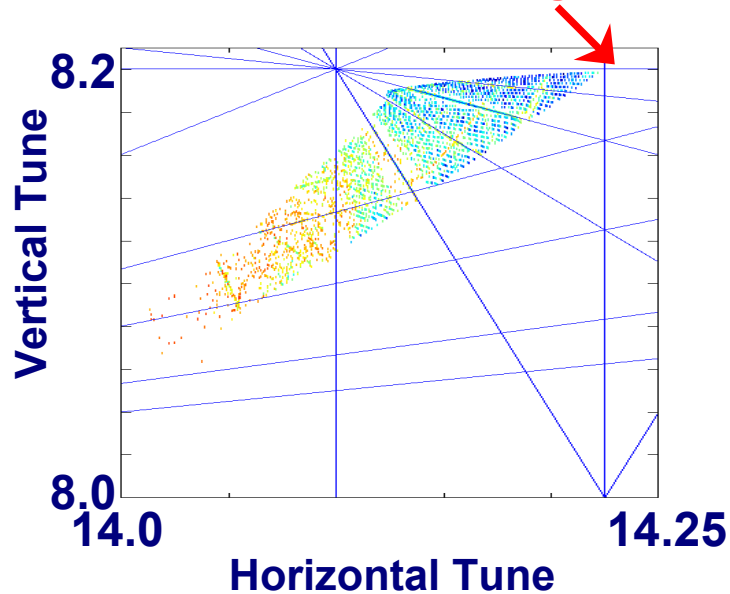

Amplitude Space

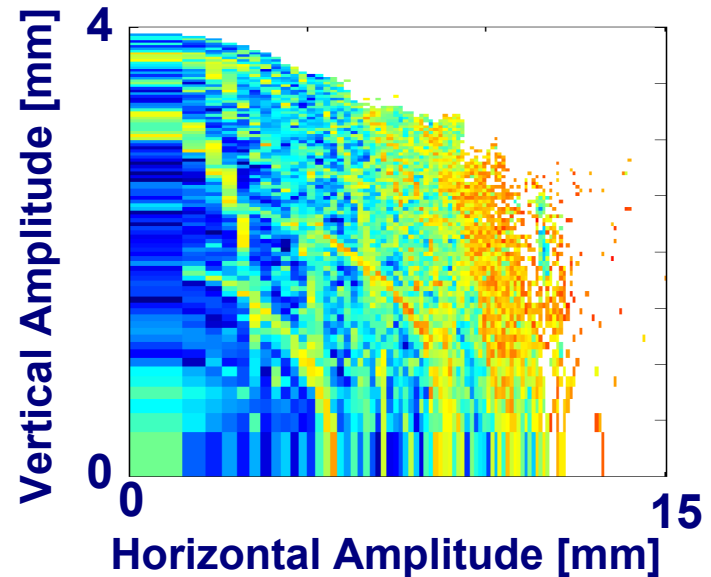

Tools and Techniques

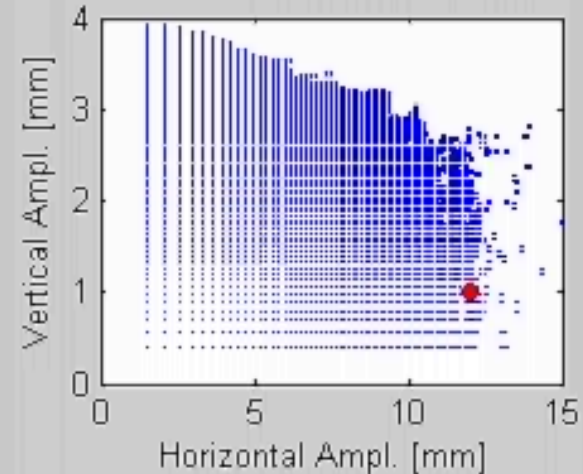
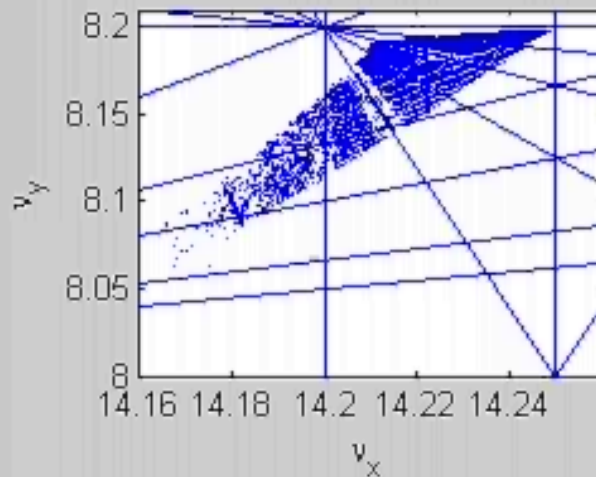
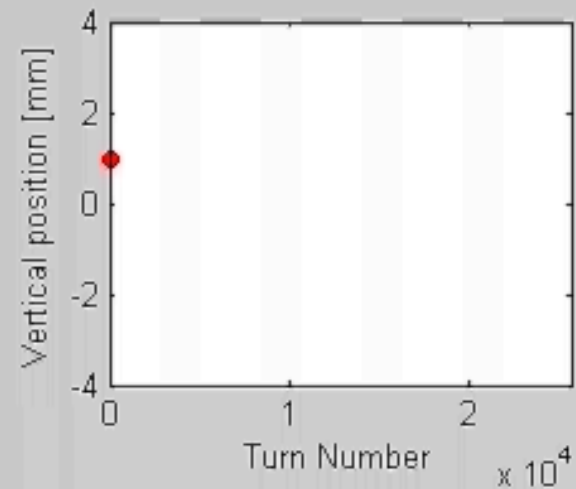
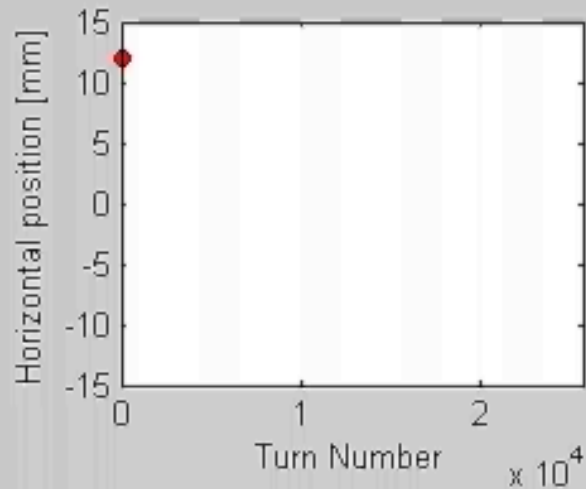

Tools and Techniques

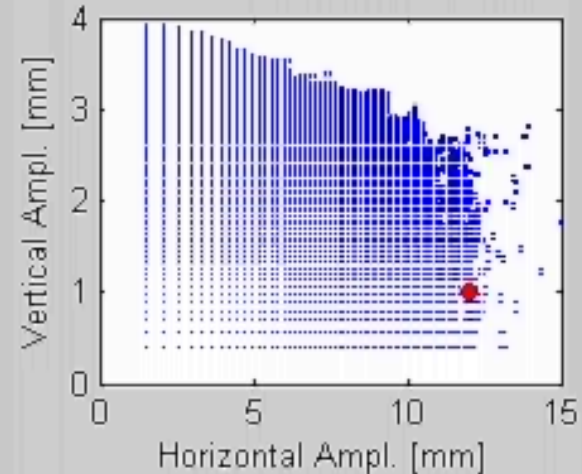
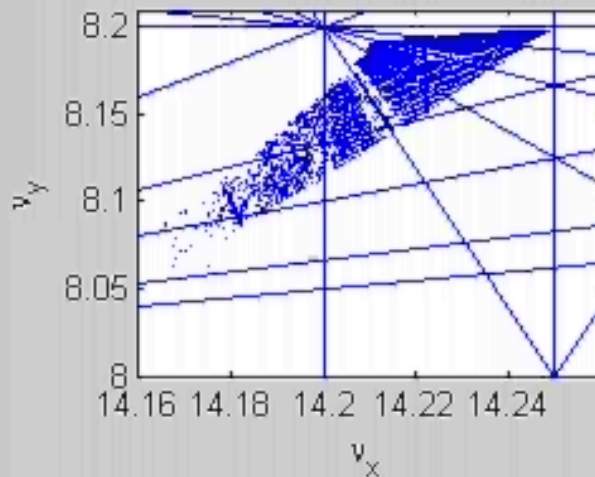
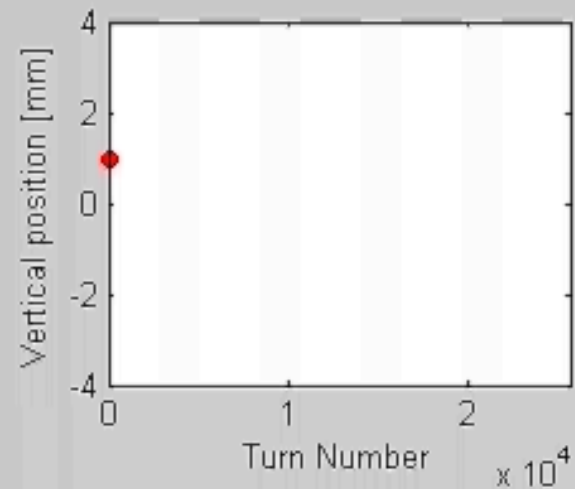
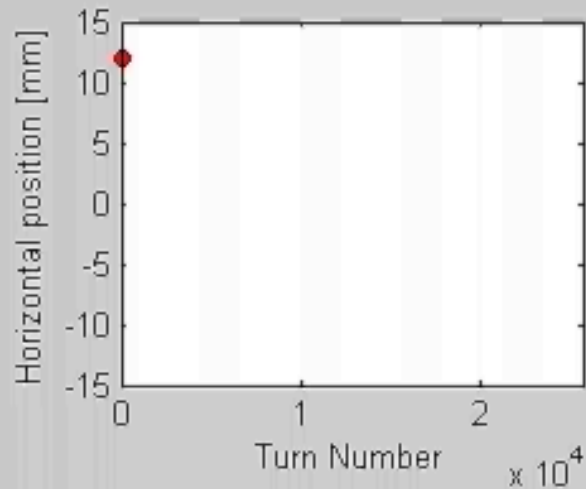

Frequency Map Analysis



Frequency Space

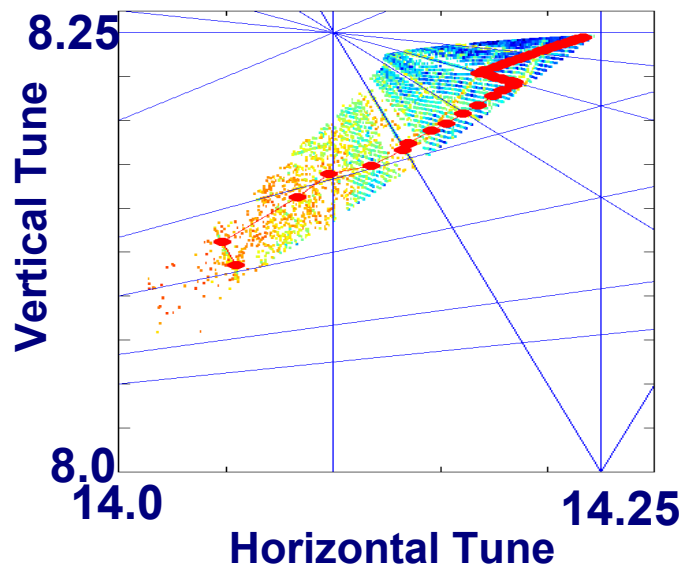

Amplitude Space

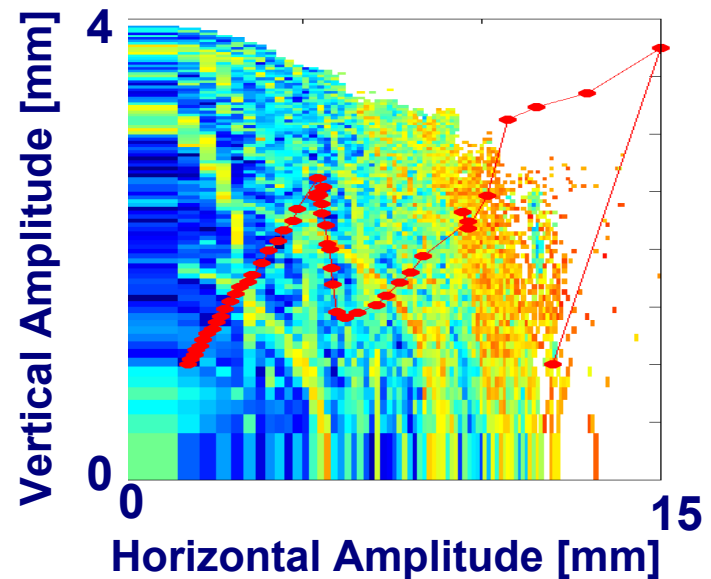

On-energy dynamic aperture - frequency map (left) versus induced amplitude (right)



Frequency Map

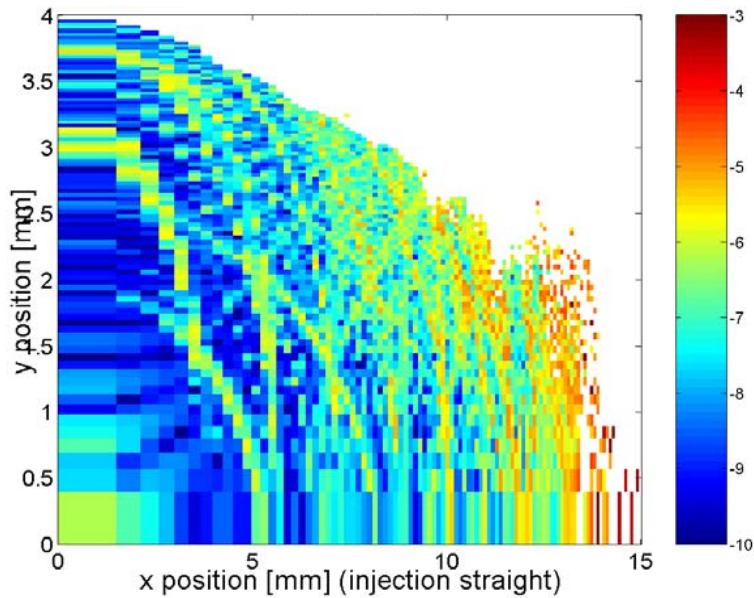

Induced Amplitude

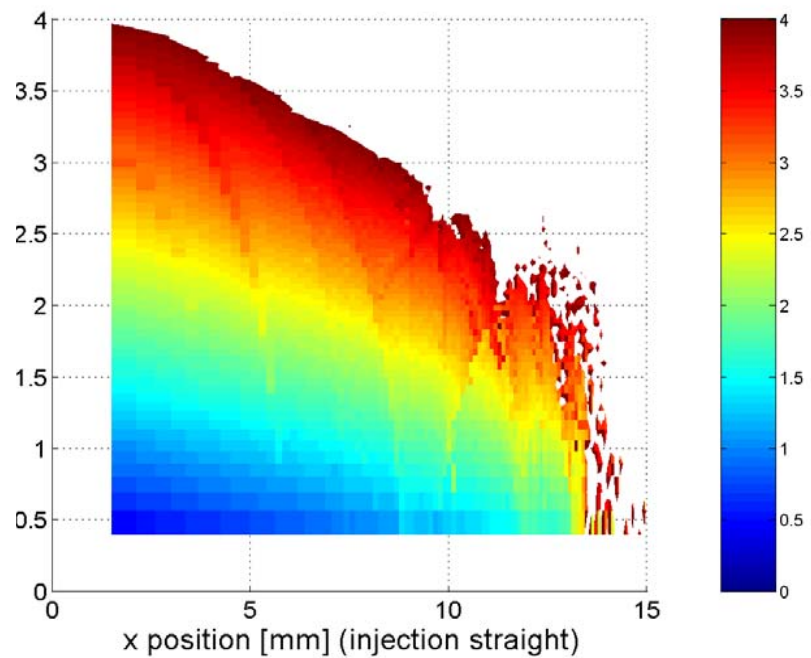

Injection efficiency



- Like to have a good injection efficiency
 - Minimize fill times
 - Minimize radiation levels
 - Top-off
 - Insertion devices
- At the ALS the injected beam is horizontally offset by $\sim 10\text{mm}$ from the stored beam when it enters the ring.
- The injected beam oscillates about the stored beam and slowly damps down.
- If particles in the injected beam encounter regions of high diffusion they can be lost.

**Goal is to ensure that the particle motion is stable
in the region where injected particles may travel**

Example : Superbend Upgrade

In three of the twelve ALS Sectors

- Replaced the central **combined function dipole** with a **Superbend** and **two quadrupoles**

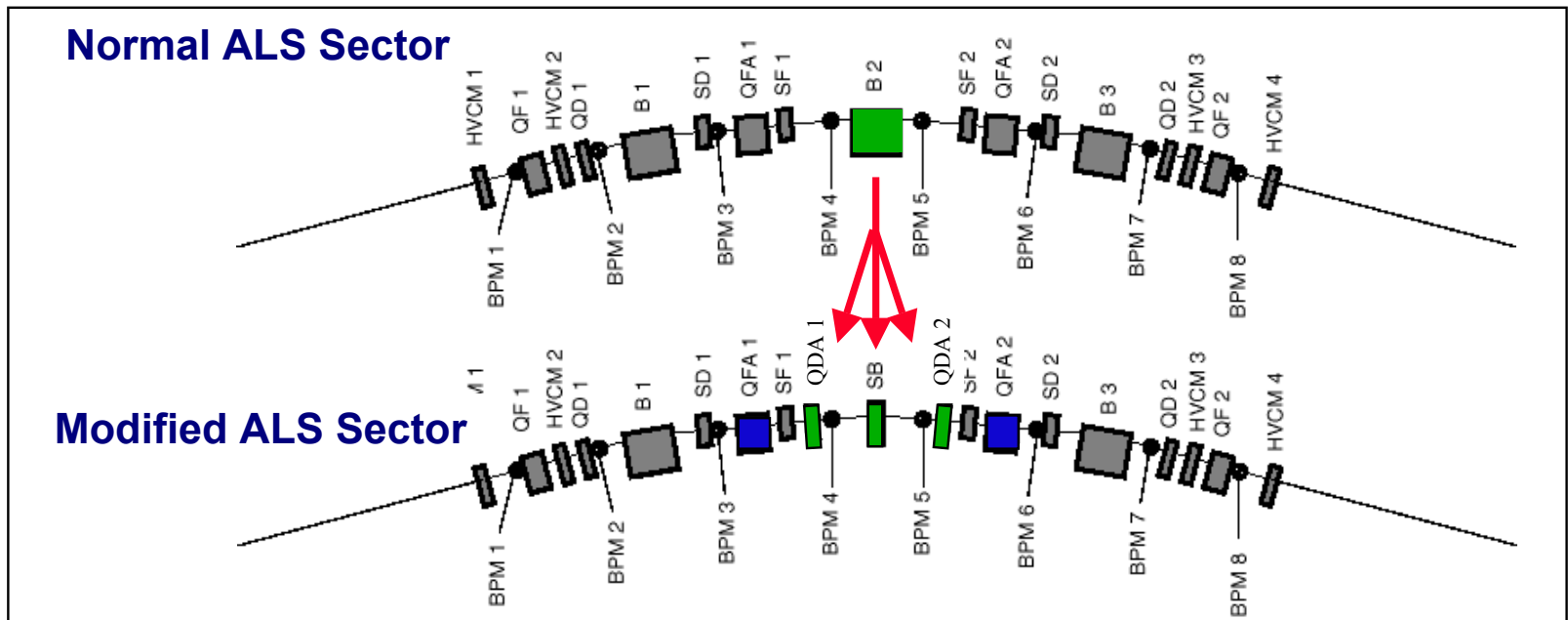

Frequency Maps without Superbends (Top) versus with Superbends (Bottom)



Amplitude Space

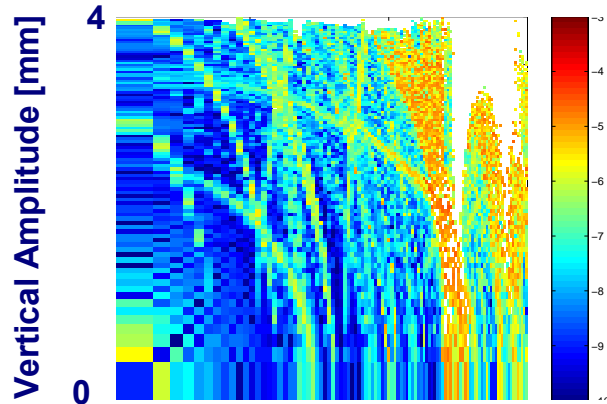

Frequency Space

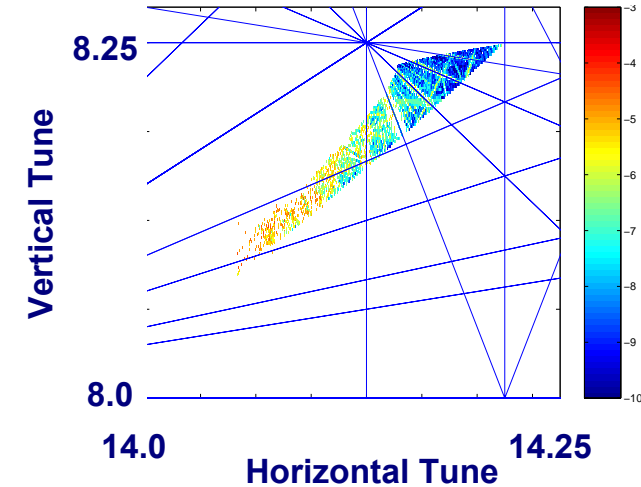
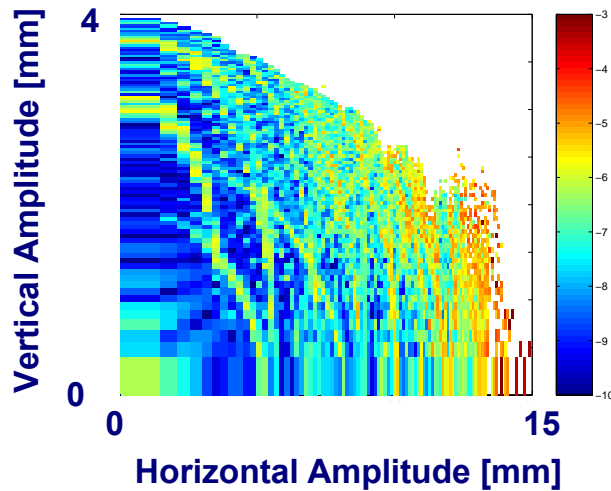
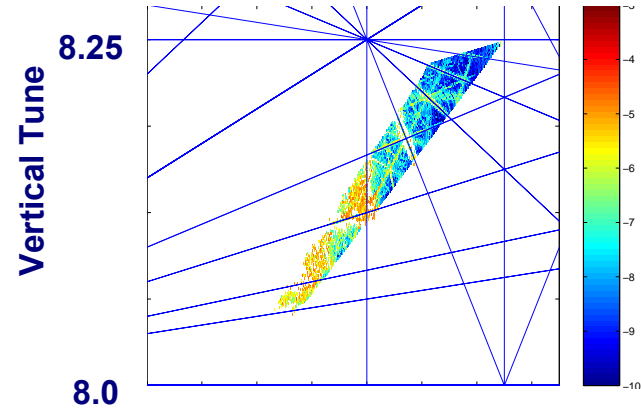

Momentum Aperture and Lifetime



Frequency Map Analysis has been extended to study the momentum aperture and the effect on lifetime

In the case of the Superbends the predictions agreed with the result to within 5%

The off energy frequency maps will be discussed in the next talk.

Other Results



Frequency Map Analysis has been an important technique for optimizing and predicting the performance of future upgrades

In addition to the Superbend Upgrade we have used FMA for studying

- Effect of Insertion Devices with Complicated Field Profiles
- Smaller Gap Insertion Devices
- Femtosecond Slicing Upgrade
- Higher Tune Lattice
- ...

Some References



1. H. Dumas and J. Laskar, Phys. Rev. Lett. 70, 2975-2979
2. J. Laskar and D. Robin, "Application of Frequency Map Analysis to the ALS", Particle Accelerators, 1996, Vol 54 pp. 183-192
3. D. Robin and J. Laskar, "Understanding the Nonlinear Beam Dynamics of the Advanced Light Source", Proceedings of the 1997 Computational Particle Accelerator Conference
4. D. Robin, J. Safranek, and W. Decking, "Realizing the benefits of restored periodicity in the advanced light source", PRST, Vol 2, 044001 (1999)
5. D. Robin, C. Steier, J. Laskar, and L. Nadolski, "Global Dynamics of the Advanced Light Source Revealed through Experimental Frequency Map Analysis", Phys. Rev. Lett. Vol. 85, No. 3 (2000)
6. C. Steier, et. al., "Measuring and optimizing the momentum aperture in a particle accelerator", Phys. Rev. E. Vol. 65, 056506
7. D. Robin and C. Steier, W. Wan, and A. Wolski, "Impact of Narrow Gap Undulators on the Advanced Light Source", Proceedings of the 2003 Particle Accelerator Conference
8. D. Robin, "Superbend Upgrade of the Advanced Light Source", Proceedings of the 2003 Particle Accelerator Conference
9. Y. Wu, E. Forest, and D. Robin, "Explicit symplectic integrator for s-dependent static magnetic field", Phys Rev. E. Vol 68 046502 (2003)