

# Cornell Linear Collider Detector Research

## Cornell Interests:

The Cornell group proposes to contribute to development of charged particle tracking for the the N. American “Large Detector” design.

**Detector Development** (in collaboration with Purdue University )  
(funding requested through UCLC)

Personnel: R. S. Galik  
J. Miyamoto (Purdue)  
D. Peterson  
I. P. J. Shipsey (Purdue)  
& students

**Event Reconstruction, Pattern Recognition**  
( funding through the LEPP base grant)

# Charged Particle Tracking at the Linear Collider

## The challenges:

### Momentum resolution

$$\delta p_t/p_t = 4 \times 10^{-5}/\text{Gev} \dots$$

(can be achieved with)

- 2 meter outer radius detector, 3 Tesla →
- 120  $\mu\text{m}$  spatial resolution
- 10  $\mu\text{m}$  intermediate detector at  $R=0.4$  m
- 10  $\mu\text{m}$  vertex detector

### Track density, Reconstruction efficiency

100 tracks/steradian ...

“full” efficiency for “energy flow”

5% occupancy goal requires

1/2000 ster. segmentation

example: 1.25cm( $r-\phi$ ) x 1cm( $z$ ) at 50cm( $R$ )

### Noise density

“1% by volume”

requires more segmentation

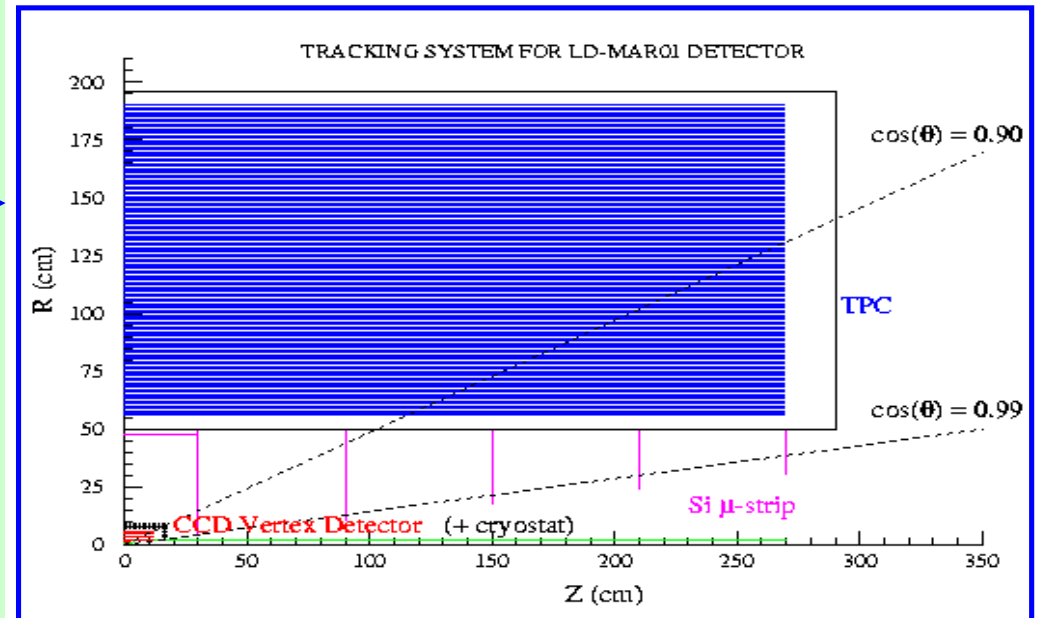

Schematic quarter-section of the N. American “Large Detector” including a 2 m radius Time Projection Chamber.

# Detector Development, issues

**GEM/MicroMegas amplification read-outs are expected to have advantages over traditional anode-amplification read-outs.**

Signals are due to **electron transport**, rather than induction.

The signal width is narrow, **typically 1 mm**, or less, providing improved **segmentation** and **resolution**.

**ExB effects**, present with anode-wire-amplification, are minimized; an improvement in resolution is expected.

**But, there are many outstanding issues.**

**Resolution:** How do we balance resolution with the size of the readout ?

GEM/MicroMegas signals may be small compared to the pad width.  $\Rightarrow$  **minimal charge sharing**

e.g. **5mm** ( $\phi$ ) x 1cm (r) pads ( 500 thousand pads )

The resolution, without charge sharing, is **1.4mm** (require  $< 120 \mu\text{m}$ ).

e.g. **1mm** ( $\phi$ ) x 1cm (r) pads ( **2.4 million pads !** )  $\Rightarrow$  **provides charge sharing**

The resolution **may** be sufficient but number of channels is prohibitive.

*While the electron transport signal is fundamentally narrower than the induction signal, sufficient ( anticipated ) resolution, in a TPC, has not been demonstrated.*

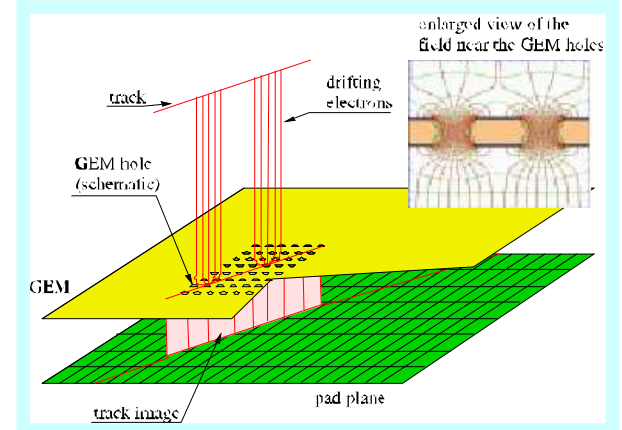

GEM readout: amplification is localized in the GEM holes. Signal is due to electron transport.

# Detector Development, Cornell/Purdue Program

Systematic study **spatial resolution** and **signal width** using **GEM/MicroMegas TPC readout** devices

amplification device,  
details of spacings and gain,  
pad size and shape  
gas

applied signal isolation/spreading (Signal may require spreading in  $\phi$  and isolation in R.)

**Signal spreading must be optimized for segmentation and resolution.**

Spatial resolution and signal width studies using **traditional anode-wire-amplification read-out** devices

Investigate a readout using smaller wire spacing to reduce the **ExB** effects.

**Ion Feedback** measurements

Instrument the high voltage plane, or an intermediate grid.

Tracking studies in a **high radiation environment**

Studies of signal distortion and electric-field break-down.

Tracking studies in a **magnetic field**

Cornell has the expertise and utilities to build and operate a superconducting test magnet.

# Currently Active/Funded R&D TPC with GEM/MicroMEGAS

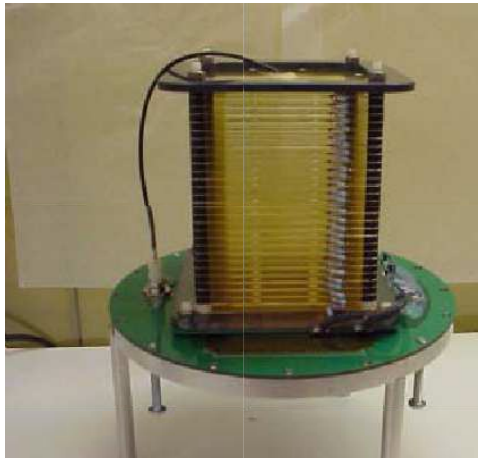

Carleton  
(GEM)

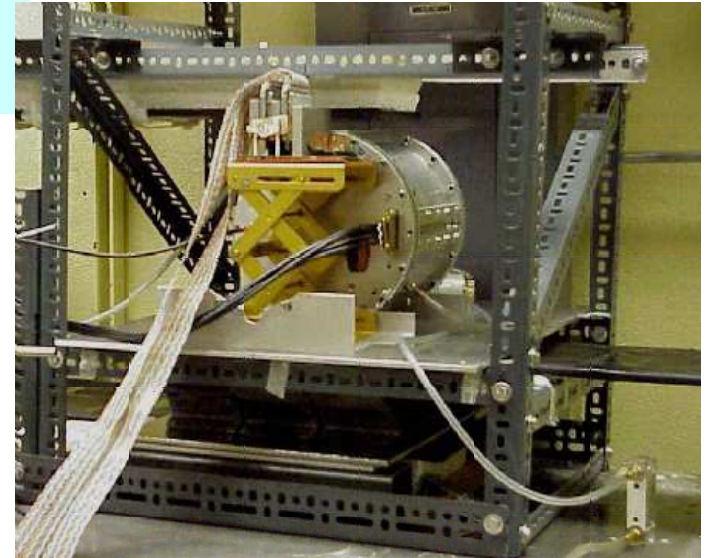
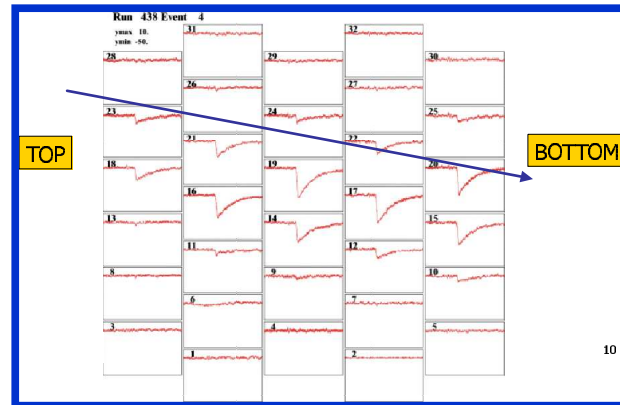

DESY (GEM)  
(printed cage)

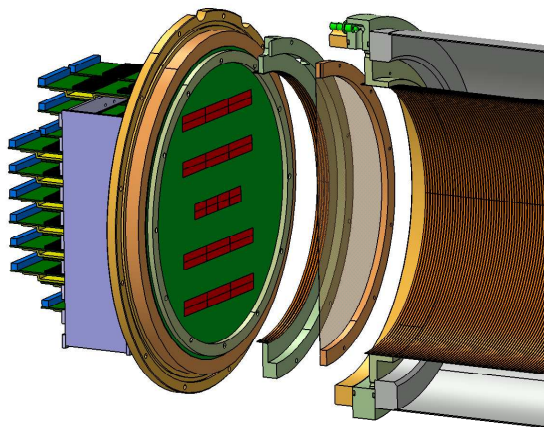

Saclay/Orsay  
(MicroMegas)



Currently Active/  
Funded R&D  
TPC with  
GEM or  
MicroMEGAS



Victoria (GEM)



Karlsruhe (fits in DESY magnet)

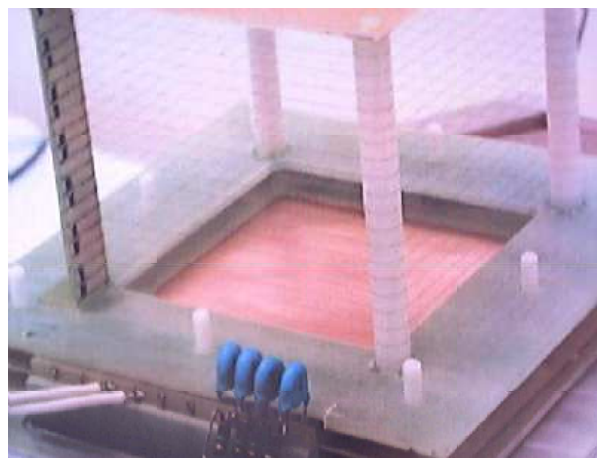

NIKHEF (GEM)

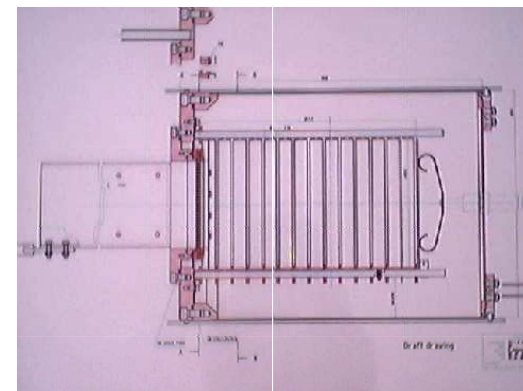

MPI Munich (wire ampl.)

# Currently Active/Funded R&D TPC with GEM/MicroMEGAS



DESY



Saclay

# what Cornell can offer

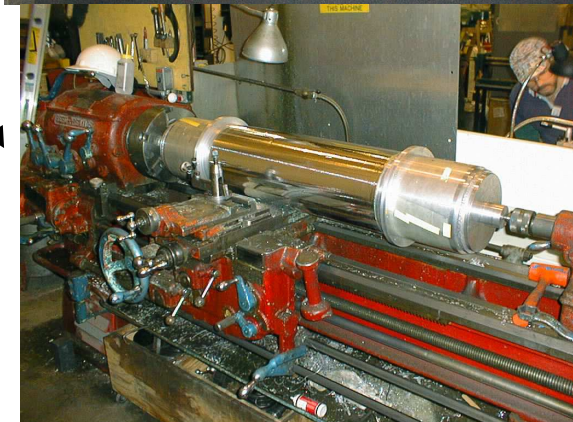
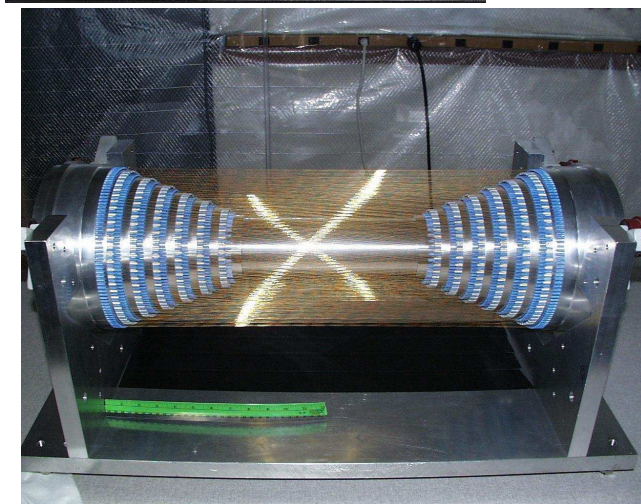
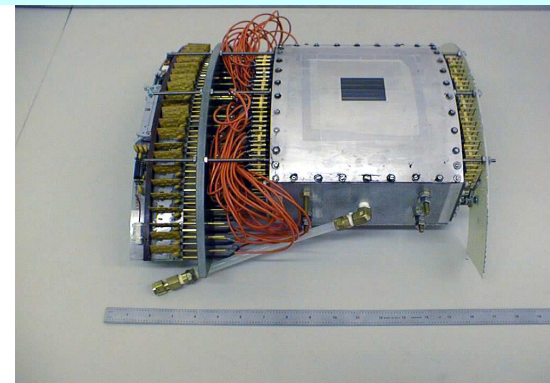
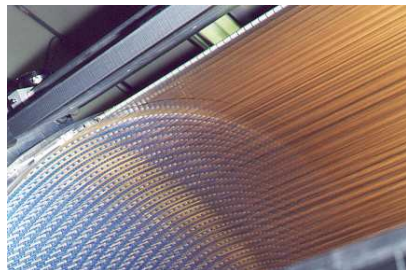
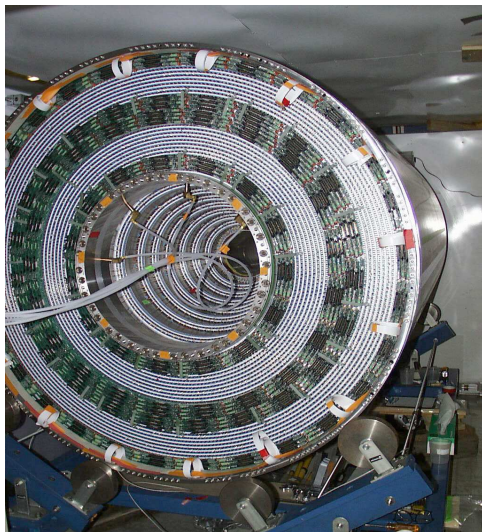

Experience with ...  
Large drift chambers for CLEO  
Test chambers  
Manufacturing  
Small drift chambers  
Innovative construction  
calibration

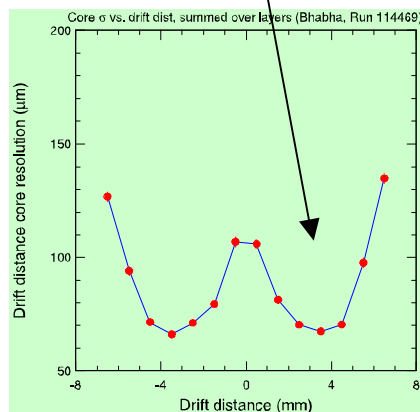



# what Purdue can offer

Years of experience with MPGDs,  
preparation and radiation hardness measurements

## Micro Pattern Detector Aging (Radiation Hardness)

Example: triple GEM with PCB readout

Gas Ar/CO<sub>2</sub> 70/30 (99.99%)

GEM1= 400 V

GEM2= 390 V

GEM3 =380 V

PCB as e<sup>-</sup> collector

Cr X-rays (5.4 KeV)

@ 6 x 10<sup>4</sup> Hz/mm<sup>2</sup> for 750hrs

Gas gain 6,000

Detector performance

small (~15% gain loss) after

~ 8 years @LHC 10 cm from IP.

Minimal signs of aging.

Best result obtained with a GEM.

Similar result obtained with

a MicroMEGAS + GEM

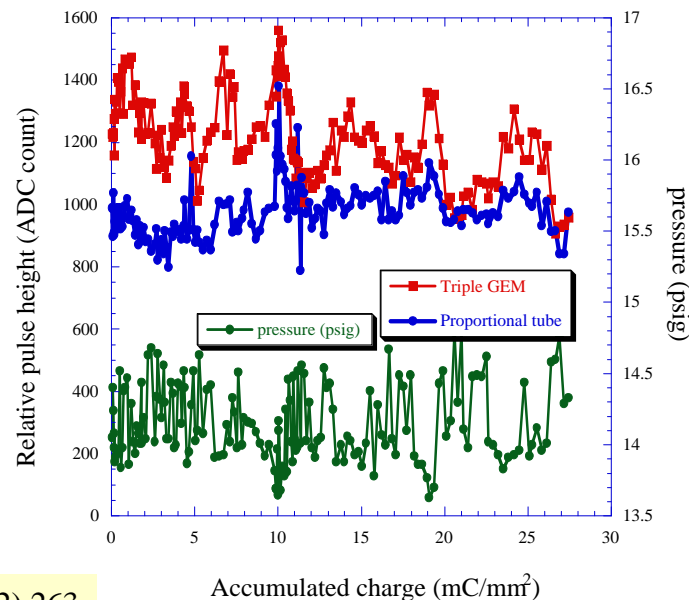

Stolen from I. Shipsey, NIM A 478 (2002) 263

# TPC Test Chamber R&D at Cornell University and Purdue University Three Year Plan

	Plan	Purchases	
(at Cornell)	1 <sup>st</sup> Year	track definition scintillator trigger small drift chambers test device, TPC power supplies data acquisition	VME crate Computer and LabView controller discriminators for drift chambers TDCs for drift chambers FADCs for TPC (limited) power supply frame power supplies electronics boards \$ 52,000 equipment
	2 <sup>nd</sup> Year	expanded TPC superconducting magnet	expanded DAQ \$ 121,000 equipment
	3 <sup>rd</sup> Year	expanded TPC superconducting magnet	expanded DAQ \$ 74,000 equipment
(at Purdue)	1 <sup>st</sup> Year	MPGD readout modules	printed circuit pad readout planes GEMs, MicroMegas \$ 10,000 equipment \$ 16,000 student support
	2 <sup>nd</sup> Year	advances in MPGD readout modules	\$ 10,000 equipment \$ 16,000 student support
	3 <sup>rd</sup> Year	advances in MPGD readout modules	\$ 10,000 equipment \$ 16,000 student support

# Short Term Activities

Cornell:

Purchases of electronics,  
set-up and testing of electronics,

are delayed until we receive UCLC funding from NFS.

*(That will be late spring 2003 under the absolute best conditions.)*

construction of a first TPC device

construction of telescope drift chambers and trigger scintillators

We can start when technical staff and machine shop staff are available,  
at the completion of the CESR-Wiggler/CLEO-inner-chamber installation,  
~ June 2003 .

Purdue:

may be ready to construct a readout module