



Ivan Bazarov
for the ERL team

Initial Beam Results from the Cornell
High-Current ERL Injector Prototype



- Parameters
- ERL phase 1a timeline
- Main technical areas
- DC gun commissioning
- Laser & photocathodes
- Space charge limit
- RF effects on the beam
- Present status and outlook



- ERL as alternative to storage rings as a continuous source of hard x-rays
- Electron (primary beam) brightness $\propto \frac{I_{avg}}{\epsilon_x \epsilon_y} = \gamma^2 \frac{I_{avg}}{\epsilon_{nx} \epsilon_{ny}}$
- E.g. modern storage rings: 200 mA
3 / 0.03 nm-rad horizontal / vertical emittances
- ERL with $I_{avg} = 100 \text{ mA}$, need $\epsilon_{x,y} = 0.2 \text{ nm-rad}$, or assuming $\gamma = 10^4$, $\epsilon_{nx,y} = 2 \text{ mm-mrad}$ normalized rms (source) emittance for comparable performance
- Short pulses desired (by some): $\sim 1 \text{ ps}$ at GHz rate



Table 1: ERL parameter list.

Parameter	Value	Unit
Beam Energy	5-7	GeV
Average Current	100 / 10	mA
Fundamental frequency	1.3	GHz
Charge per bunch	77 / 8	pC
Injection Energy	10	MeV
Normalized rms emittance	$\leq 2 / 0.2$	mm-mrad
Energy spread (rms)	0.02-0.3	%
Bunch length in IDs (rms)	0.1-2	ps
Total radiated power (typical)	400	kW
X-ray brilliance	10^{22}	**

** Photon / (sec·mrad²·mm²·0.1% BW)

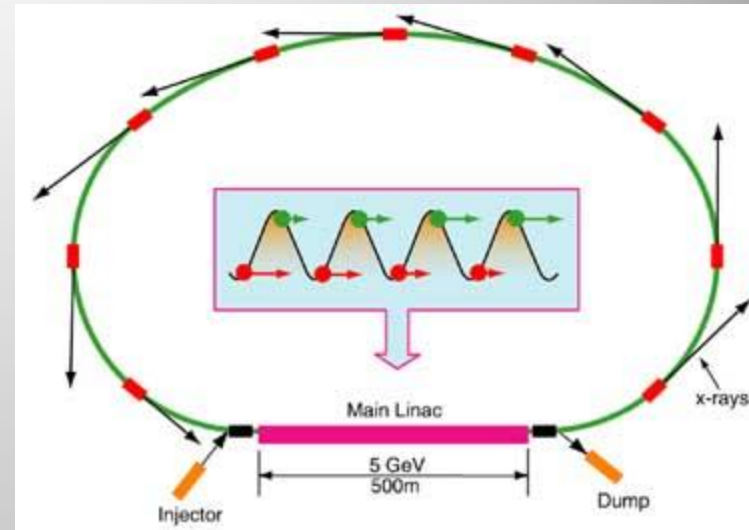

- No suitable electron source exists to drive an ERL
- Cornell ERL prototype proposed in 2001: to address outstanding source and high avg current issues



ERL Phase 1a: source R&D

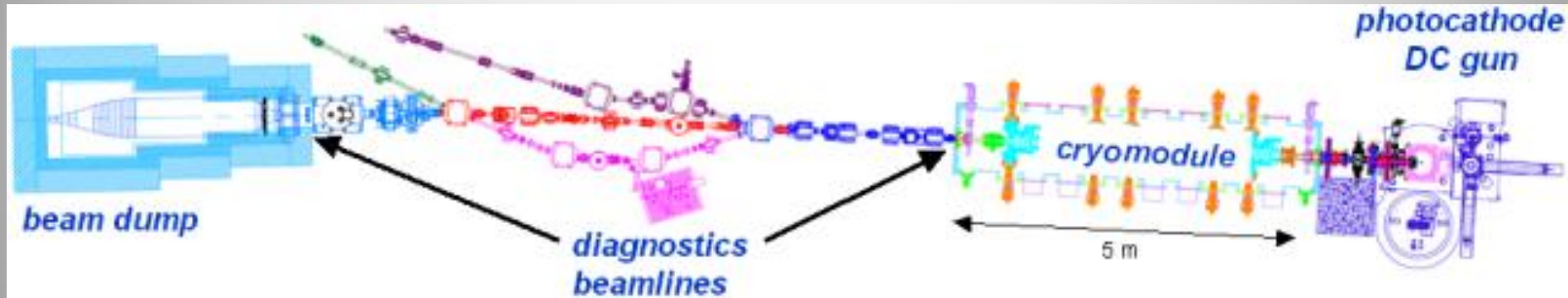

Beam energy	5-15MeV
Max average current	100 mA
RMS norm. emittance	≤ 2 mm-mrad
Max beam power	0.5 MW
RMS pulse duration	2-3 ps



- 2001: ERL prototype proposal submitted
- 2005: NSF funds the injector part (~45%) of the proposal, \$\$\$ received on Valentine's day
- 2006: Sept 7, 1st beam time out of DC gun
- 2007-8: Photocathode studies and space charge characterization underway using 50MHz laser
- 2008: Spring. Completion of the SRF injector cryomodule
- 2008: Summer. Accelerator installation finished. July 9, 1st beam with all SRF cavities on

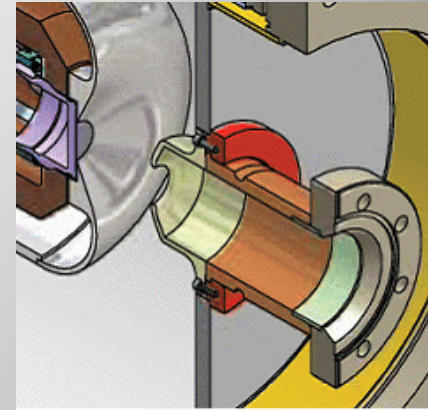

- Three photogun types: DC, normal conducting RF, superconducting RF
- **DC**: 10mA max, 5 mm-mrad (100 pC)
good vacuum (low gradient ≤ 10 MV/m, breakdn.)
- **RF**: 32mA max, 5-10 mm-mrad (1-7nC), some vacuum issues (26MV/m cathode gradient, heating)
- **SRF**: promises 30MV/m or more cathode field, good vacuum, no experience with high current (yet)
- *No fundamental reason* to choose one or the other: we picked DC gun because of expertise available



- Beam studies after the DC gun till 03/2008
- Thereafter, commissioning the 10MeV injector

10 MeV photoinjector

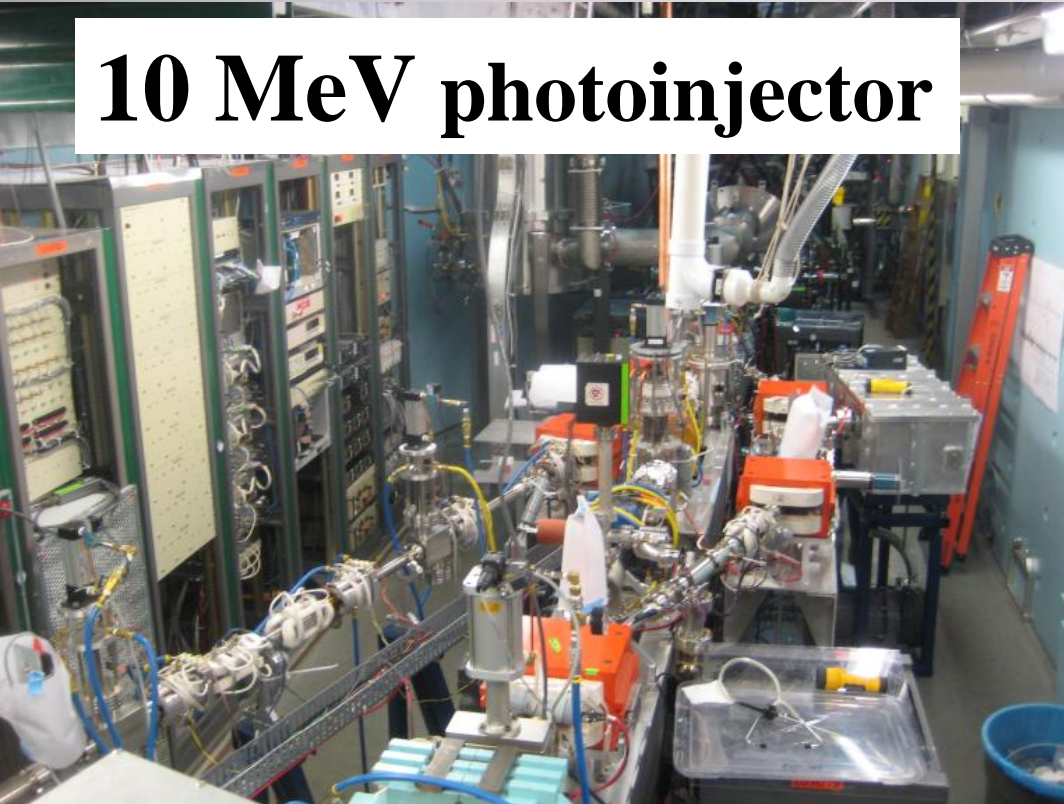

before 03/2008

gun dev. lab





- *DC photogun* operational for over 3 years
- Strong points: quick photocathode removal & activation, excellent vacuum (good lifetime)
- Major issue: *field emission & ceramic puncture* (425→250 kV)
- *Laser system*: individual pulse characteristics demonstrated at $\times 26$ lower rep. rate
- Ran into several (thermal handling) difficulties when trying to extend avg power to 20W green (>50 W IR)

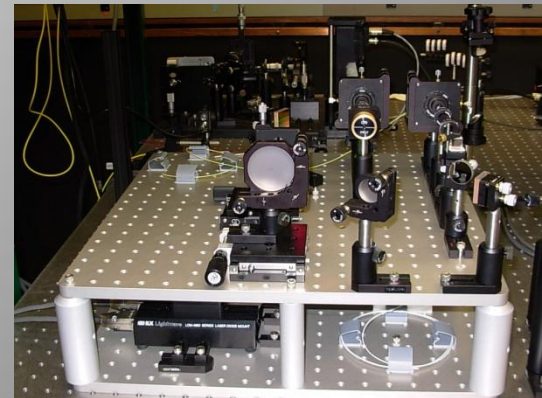
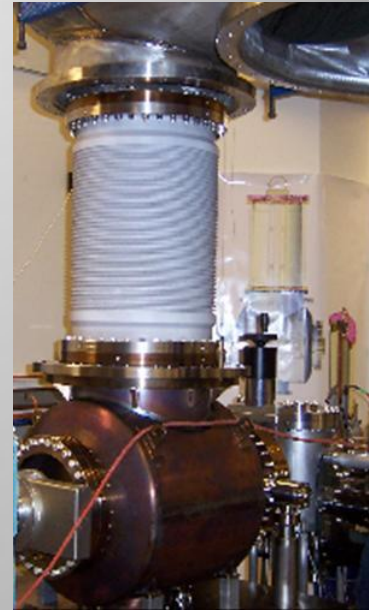



- Talk next week by Matthias
- RF installation beam ready as of May 2008
- SRF cavities processed to allow 10MeV operation, further processing underway to reach 15MeV (some issues with low Q_0 's)
- Good field stability
- Tricky to setup 1st cavity due to $V_{\text{gun}} = 250 \text{ kV}$
- Discovered problems with stray magnetic fields inside the module





Beam instrumentation to characterize 6D phase space

Emittance measurement

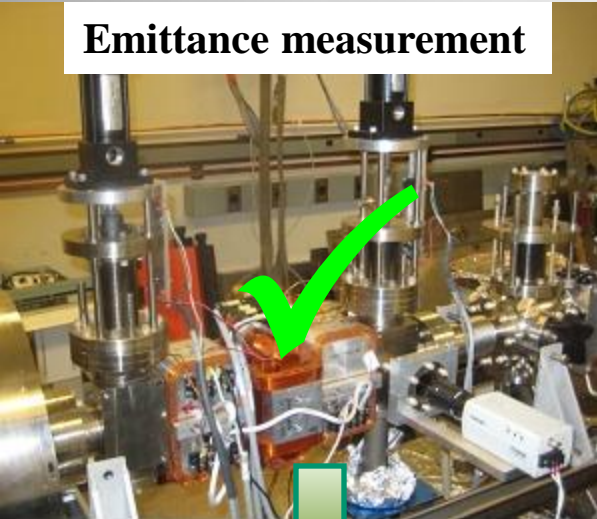

Time domain (<0.1ps)

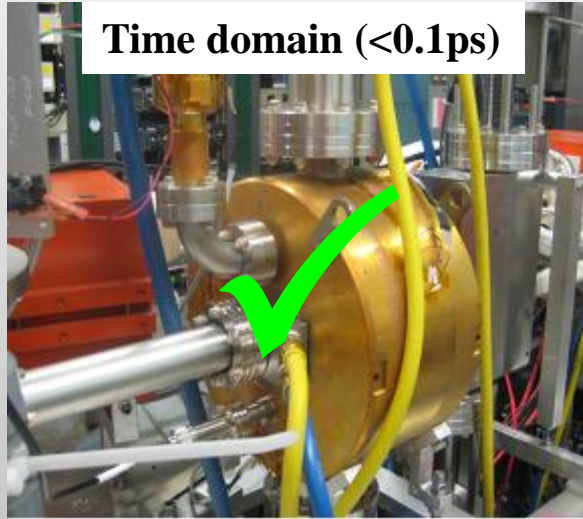

'Flying wire' ~MW beam transverse profile

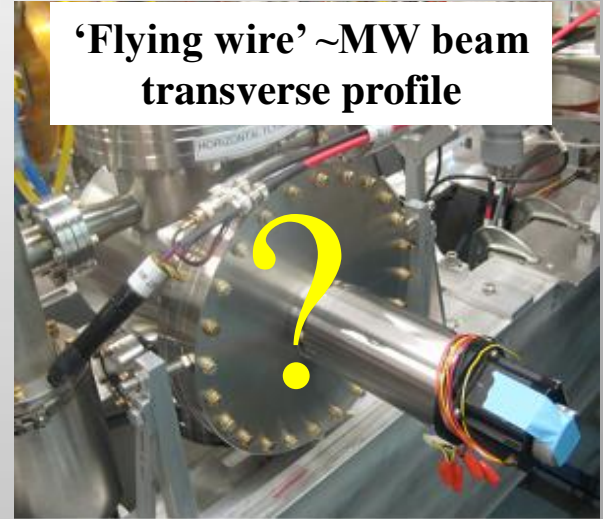

$\Delta\theta \uparrow$

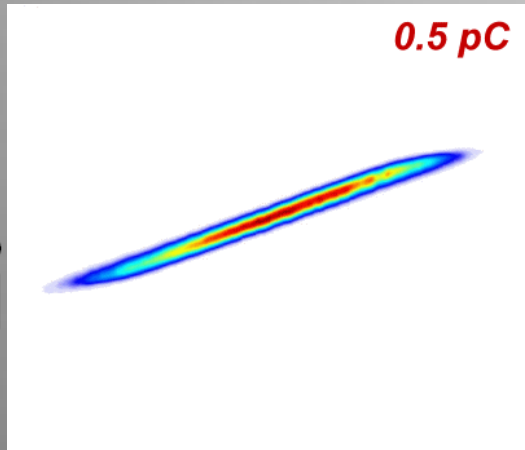

$\Delta x \rightarrow$

BPMs, Timing & Control System

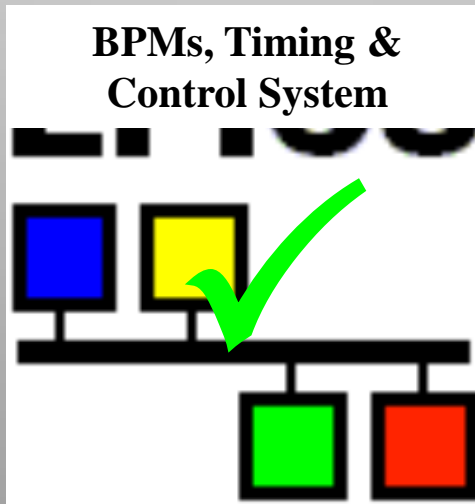

THz interferometer for bunch profile characterization

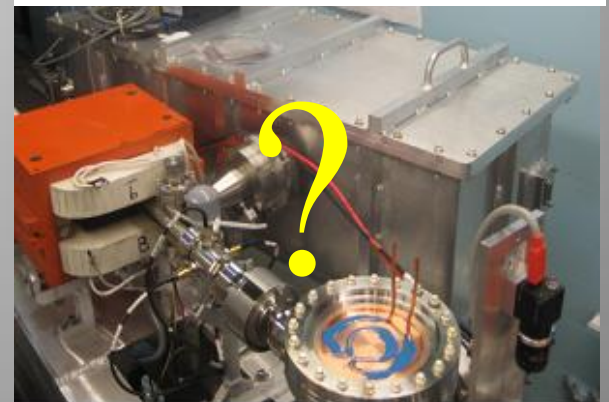



Space charge brightness limit

- For *short* laser pulse (pancake beam after emission), *max charge density* is defined by E_{cath}
- Solid angle is set by transverse momentum spread of photoelectrons characterized by *trans. temperature*
- Combining these two leads to normalized brightness and emittance limits

$$\frac{B_n}{f} \Big|_{\text{max}} = \frac{\epsilon_0 m c^2}{2\pi} \frac{E_{\text{cath}}}{kT_{\perp}} \quad \epsilon_{n\perp} = \sqrt{\frac{3}{10\pi\epsilon_0 m c^2}} q \frac{kT_{\perp}}{E_{\text{cath}}}$$

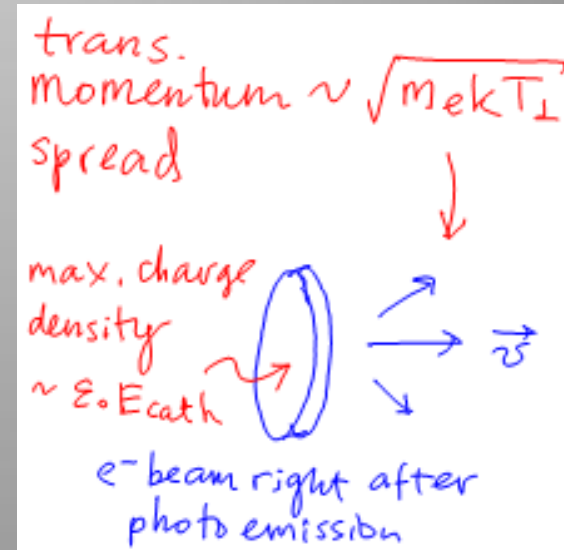



- Space charge forces must be controlled at all stages in the injector (*space charge dominated*)
- Virtual cathode: quenching of accelerating gradient due to excessive charge extraction
- Stay away from this limit ($q/q_{vc} < 1/2$) to avoid brightness degradation at the photocathode



- *Pack a bunch smartly*: putting as many electrons in each bunch as possible does not work...

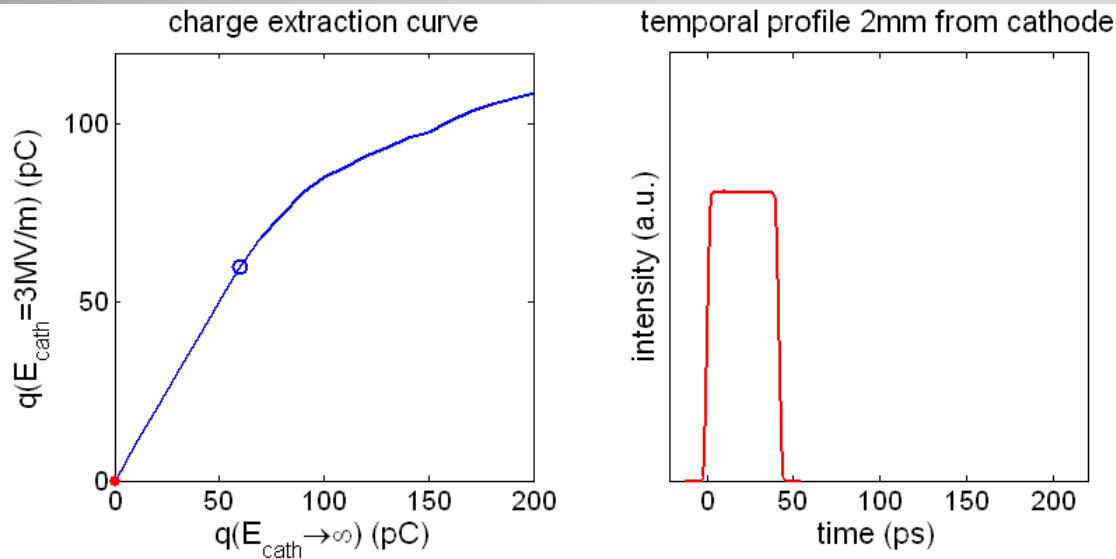



- *Pack a bunch smartly*: putting as many electrons in each bunch as possible does not work...

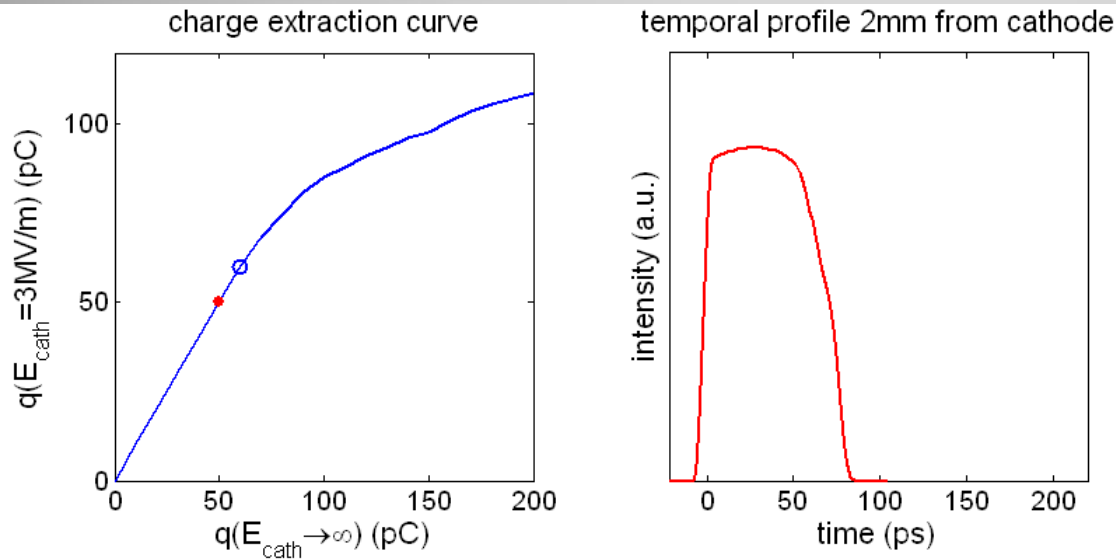



- *Pack a bunch smartly*: putting as many electrons in each bunch as possible does not work...

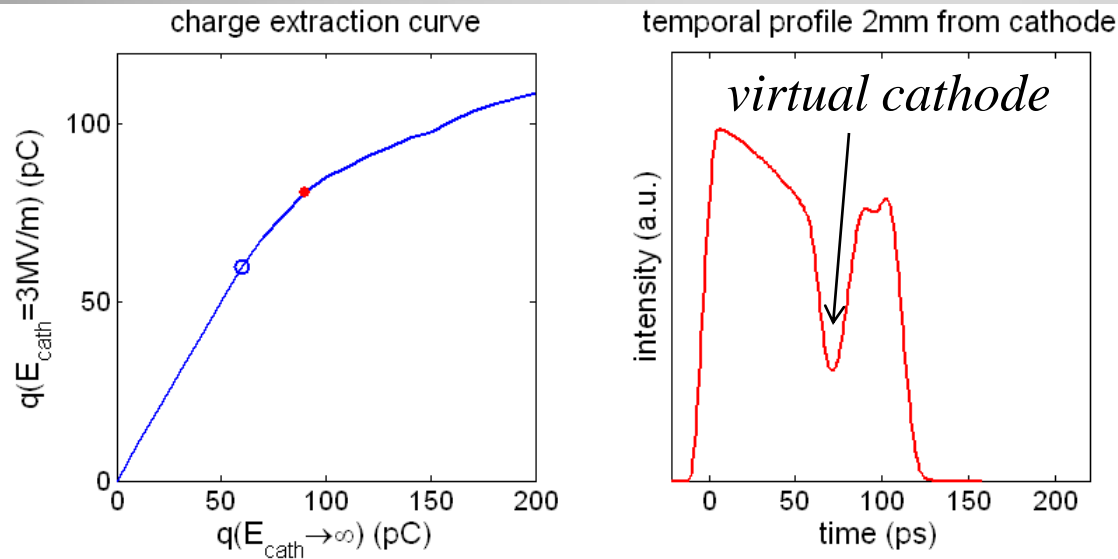



- *Pack a bunch smartly*: putting as many electrons in each bunch as possible does not work...

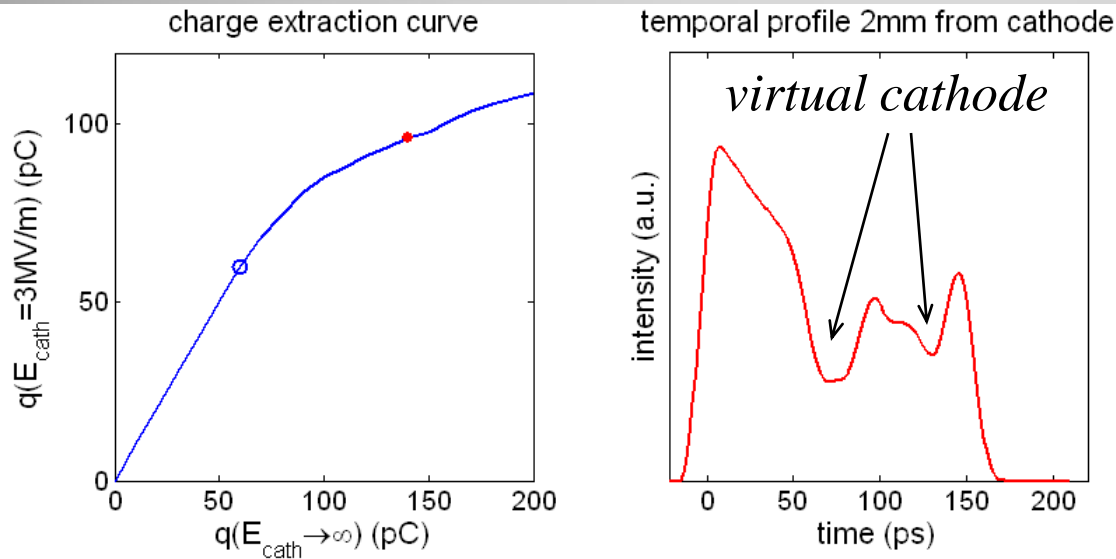



$80 \text{ pC}, \epsilon_{nx} = 1.8 \pm 0.2 \mu\text{m}$

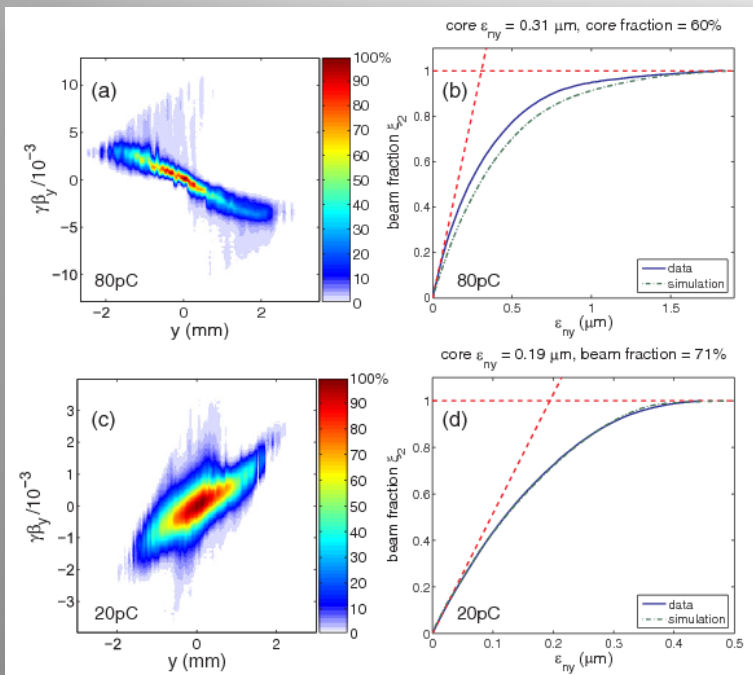

$20 \text{ pC}, \epsilon_{nx} = 0.43 \pm 0.05 \mu\text{m}$

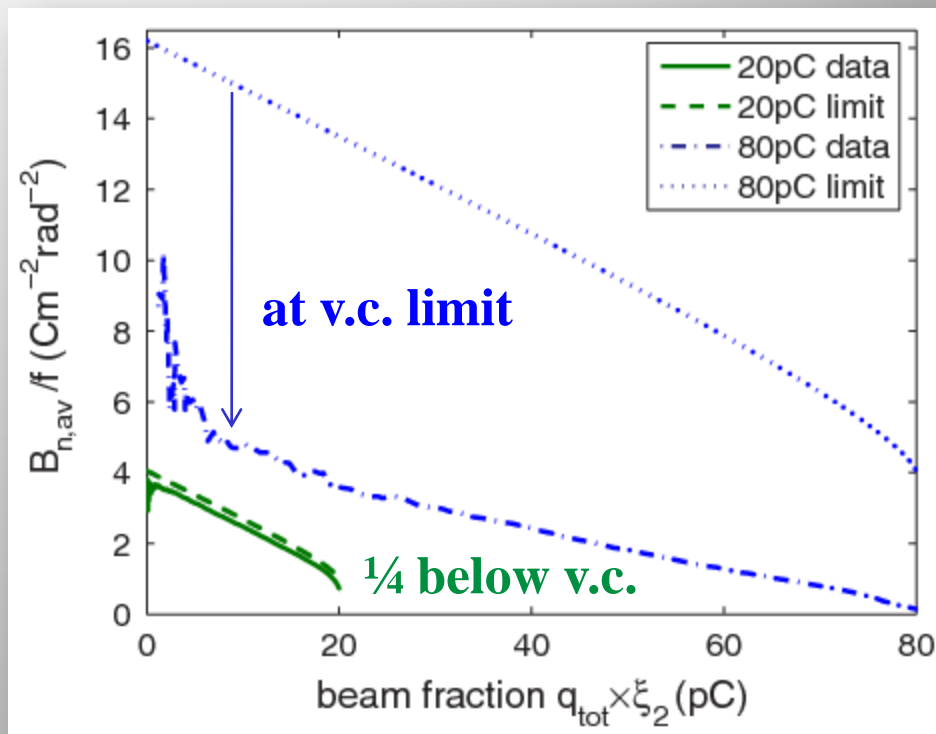

PRL, 102 (2009) 104801



Gun beamline studies

- Benchmarking space charge codes
- Photocathode characterization
- Laser shaping and temporal characterization

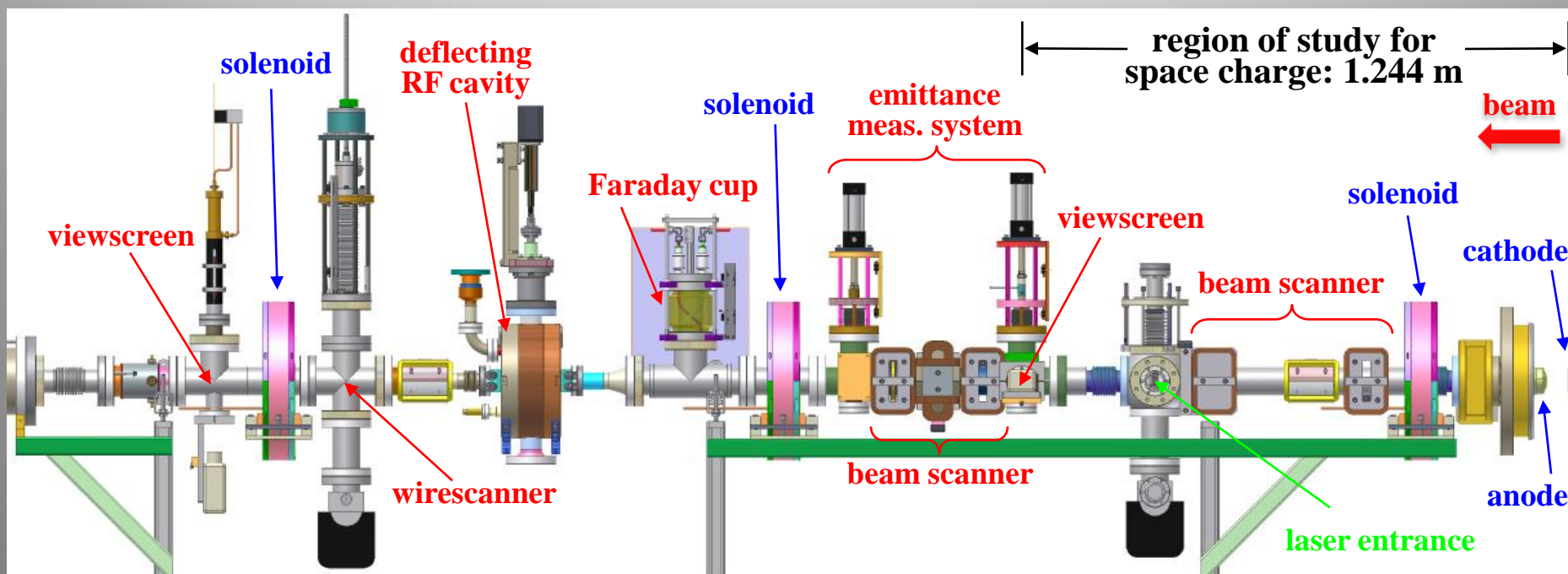
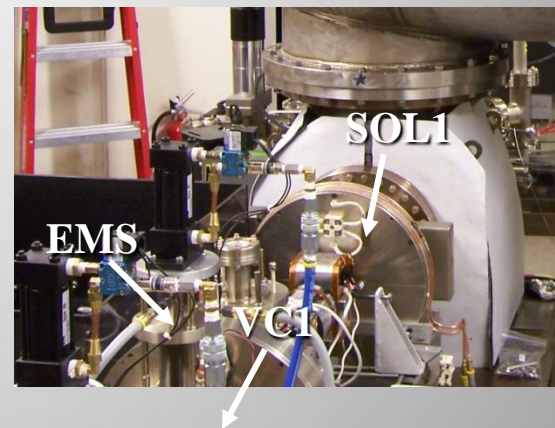



Space charge code validation

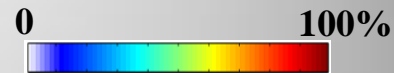

20 pC/bunch

$z = 1.244\text{m}$

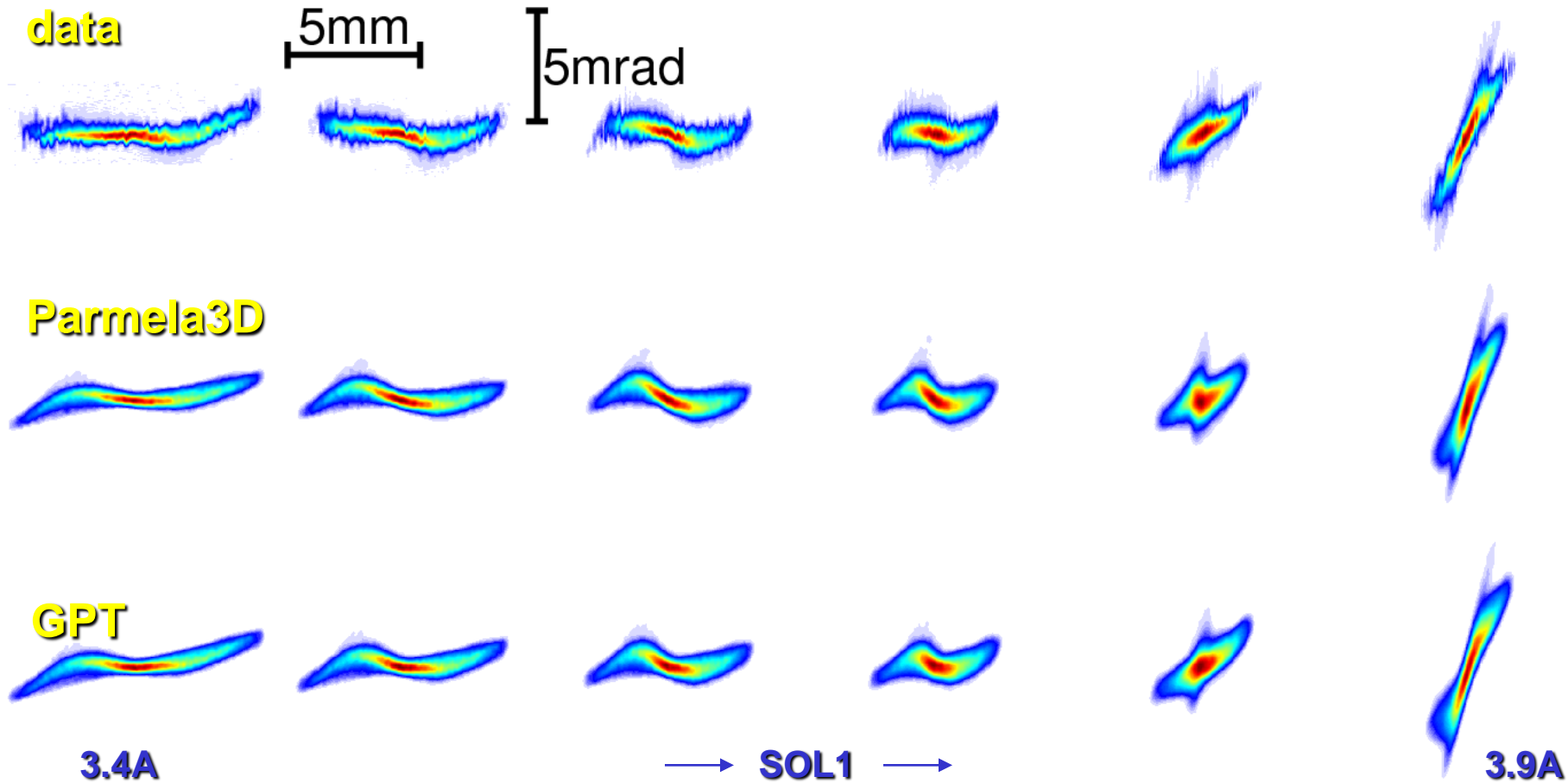

PRSTAB, 11 (2008) 100703



- Beam quality-wise, two important figures of merit
 - Effective transverse thermal energy → brightness limit
 - Response time → one's ability to shape laser and linearize space charge forces
- Limiting our study to NEA photocathodes: GaAs, GaN, and GaAsP
- GaAs remains the best out of what we looked into (no perfect photocathode)



kT vs. wavelength

relates spot size to emittance

$$\epsilon_{n,th} = \sigma_{\perp} \sqrt{\frac{kT}{mc^2}}$$

JAP, 103 (2008) 054901
JAP, 105 (2009) 083715

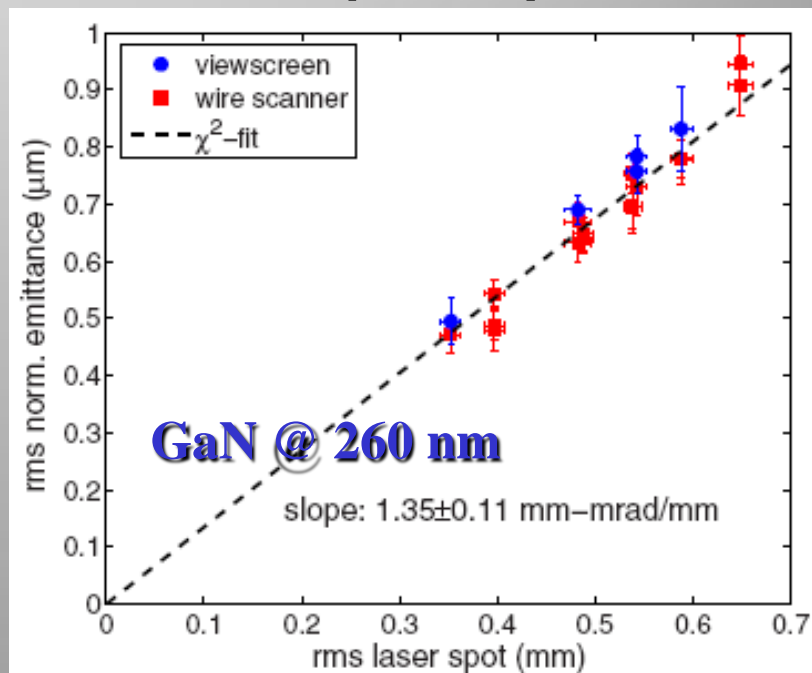
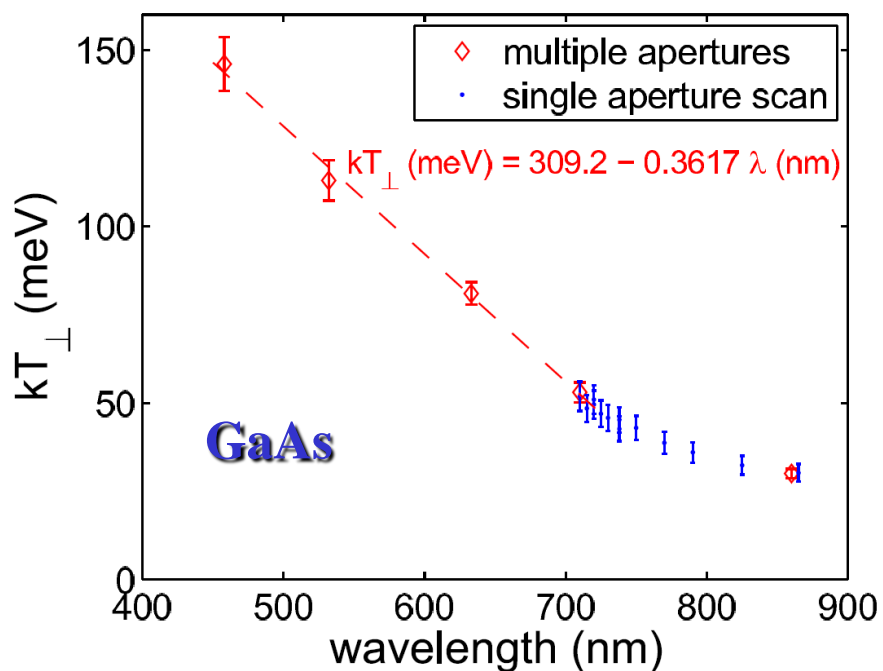
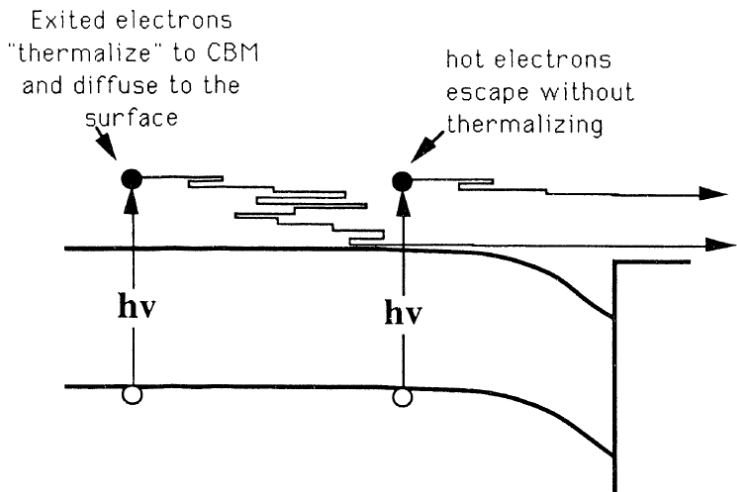



- Desired 3D distribution in free space is a uniformly filled ellipsoid \rightarrow linear space charge forces
- Actual ideal laser shape is convoluted by
 - The boundary condition of the cathode
 - Nonrelativistic energy / bunch compression

desired laser shape

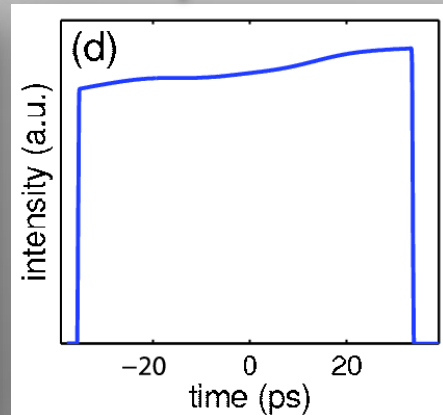
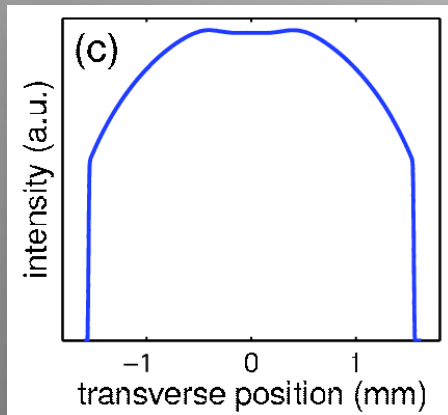

shape after the gun

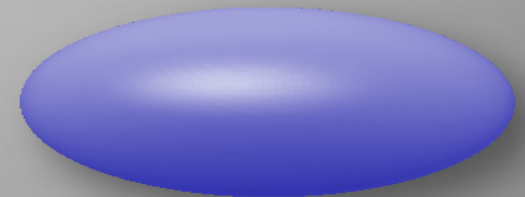



One robust method

App Opt, 46 (2007) 8488

PRSTAB, 11 (2008) 040702

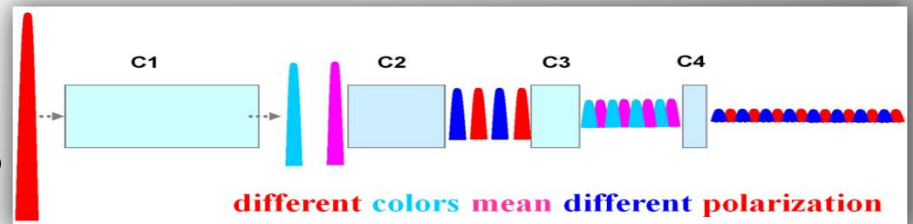

One crystal

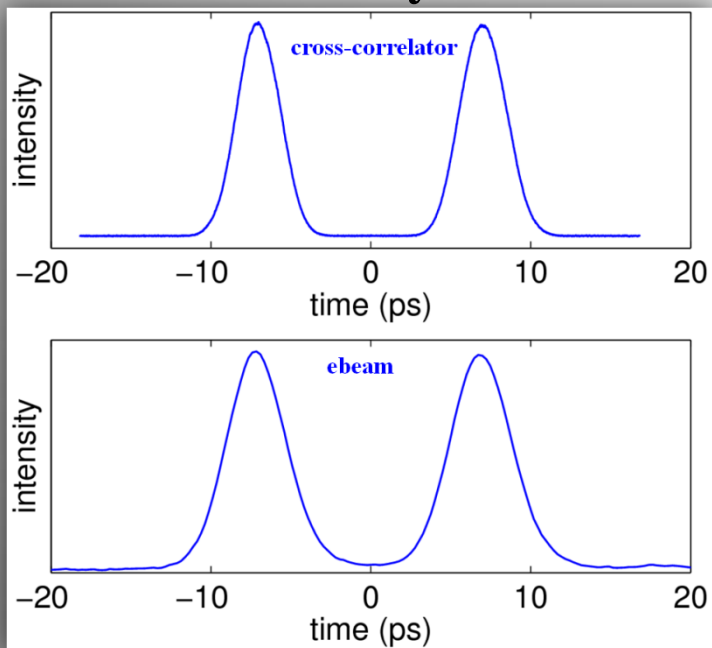

Three crystals

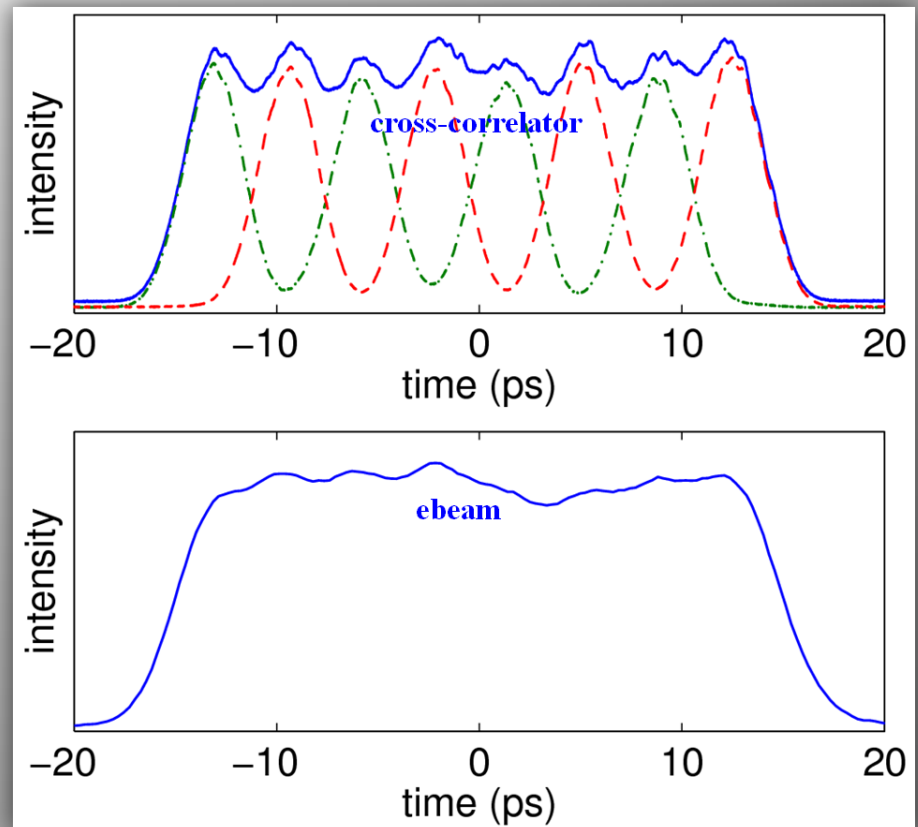

useful diagnostics tool with RF on



$$\varepsilon_n = \frac{1}{mc} \sqrt{\langle x^2 \rangle \langle p_x^2 \rangle - \langle xp_x \rangle^2}$$

$$p_x(x, z) = p_x(0,0) + \underbrace{\frac{\partial p_x}{\partial x} x}_{\text{kick}} + \underbrace{\frac{\partial p_x}{\partial z} z + \frac{\partial^2 p_x}{\partial x \partial z} xz}_{\text{focusing}} + \dots$$

kick

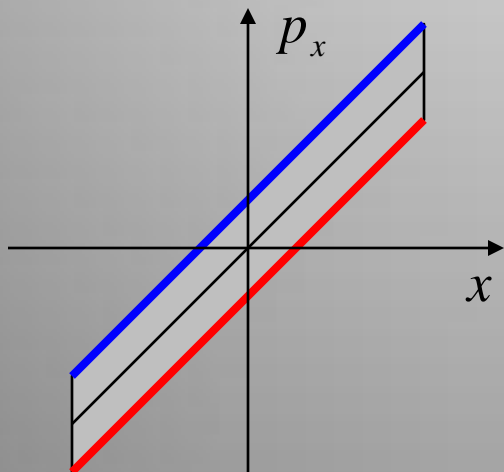

tail head



focusing

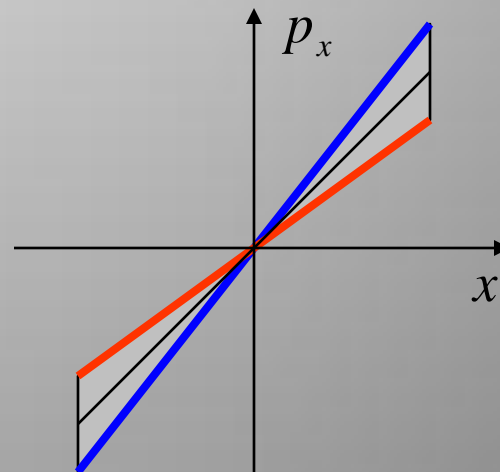

- If space charge is kept in check (force is linear), RF induced emittance dominates
- RF cavities focus or defocus the beam depending on phase, kinetic energy and gradient

$$\epsilon_{rf} = \frac{1}{mc} \left| \frac{\partial^2 p_x}{\partial z \partial x} \right| \sigma_x^2 \sigma_z$$

Before 1st cavity

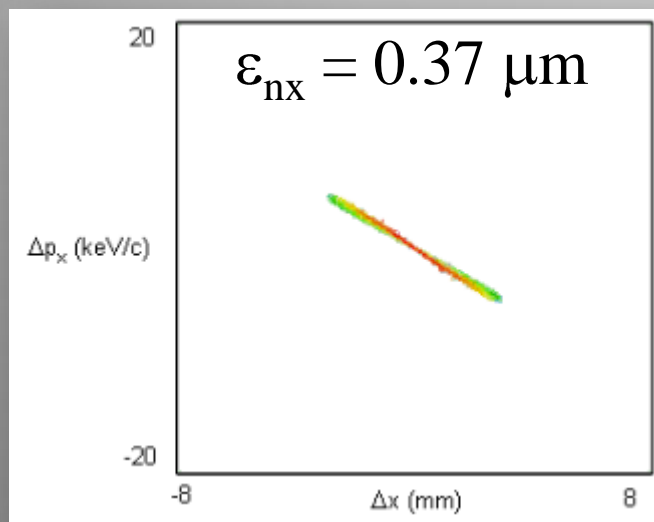

rf emittance growth "bow-tie" pattern

After 1st cavity

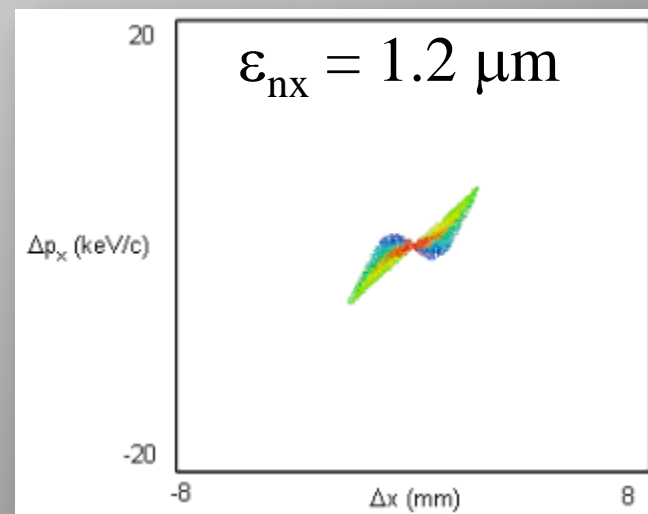



- RF induced emittance growth can be cancelled (yet to be demonstrated with beam)

$K.E. = 0.5 \text{ MeV}$

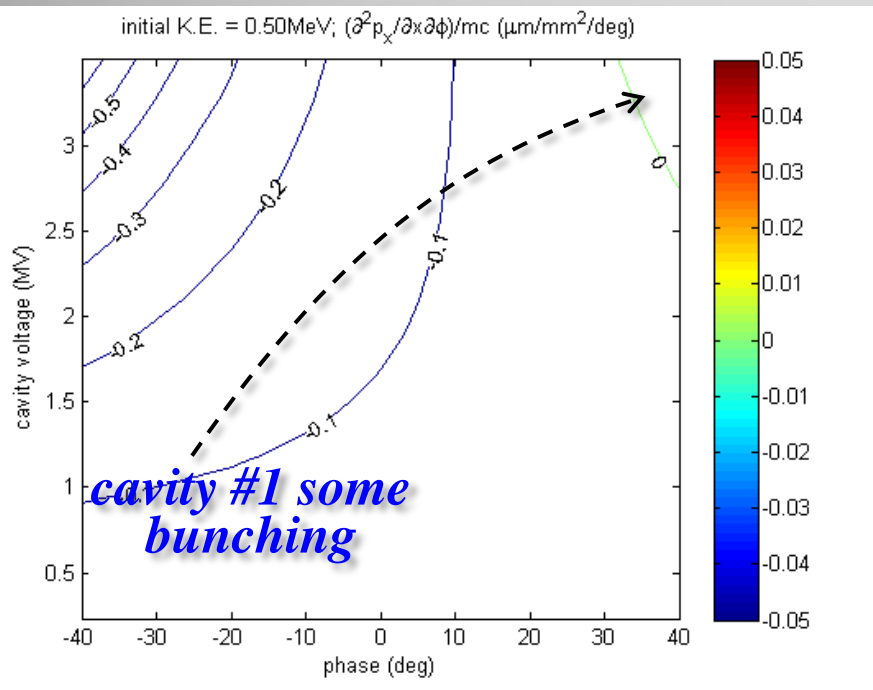

$K.E. = 3 \text{ MeV}$

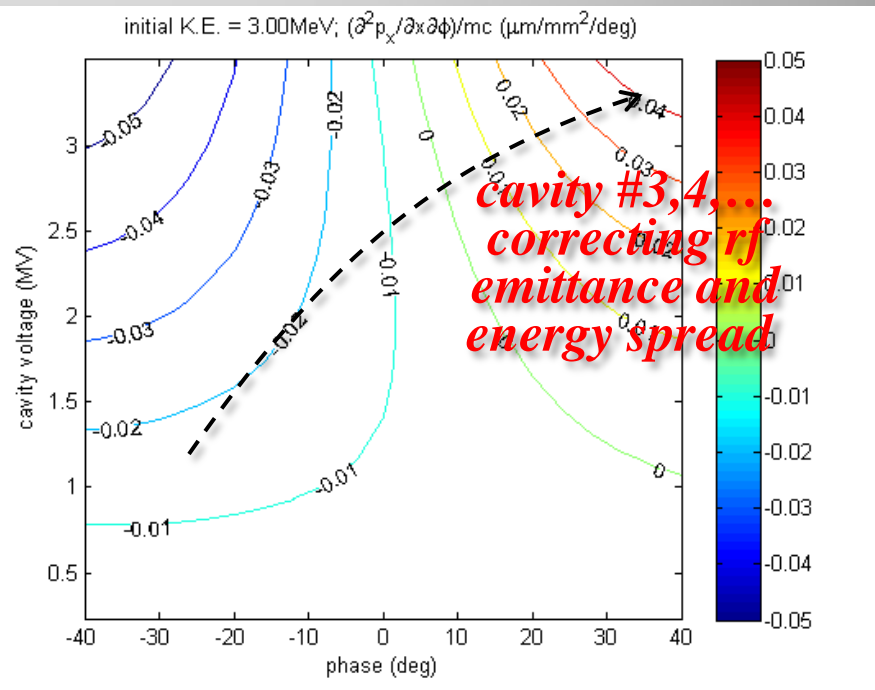



Low gun voltage implications

- Low gun voltage introduces several challenges in the 1st cavity
 - Energy gain is transverse position dependent
 - 1st cavity acts as a phase shifter
- Time & energy diagnostics proves very useful

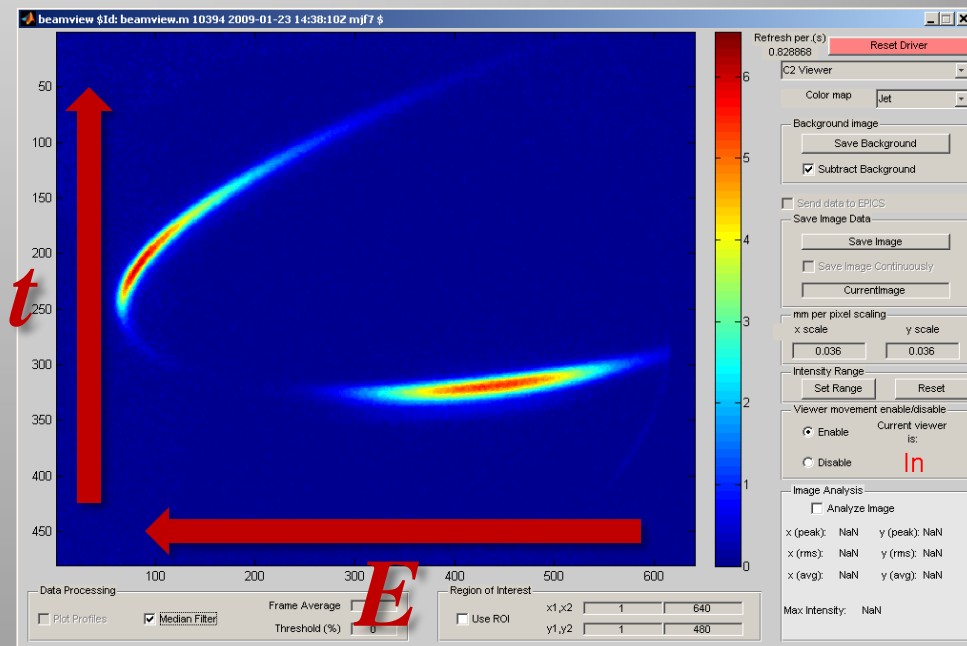
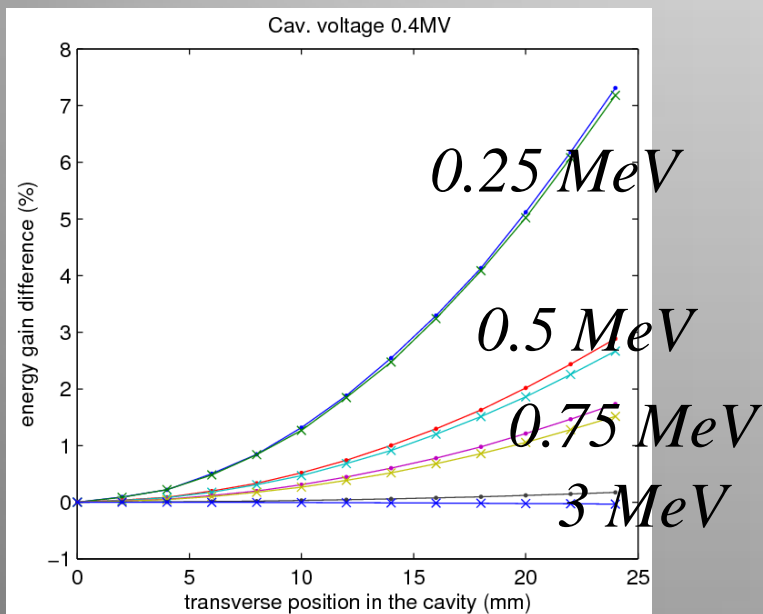



gas backstream from the dump

- 20 mA DC current demonstrated from the gun as limited by gas backstream from the dump (~5m away)

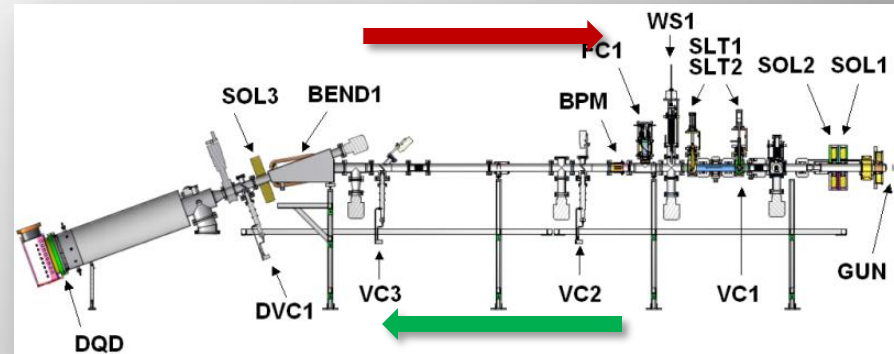

beam direction

- 5MeV beam running so far reached 4mA as limited by our ability to setup a clean beam (radiation losses)



Problem with the cryomodule

- Stray magnetic fields inside the cryomodule increase losses and thwart beam based alignment
- Planning to open the cryomodule to eliminate the problem

Grid pattern downstream

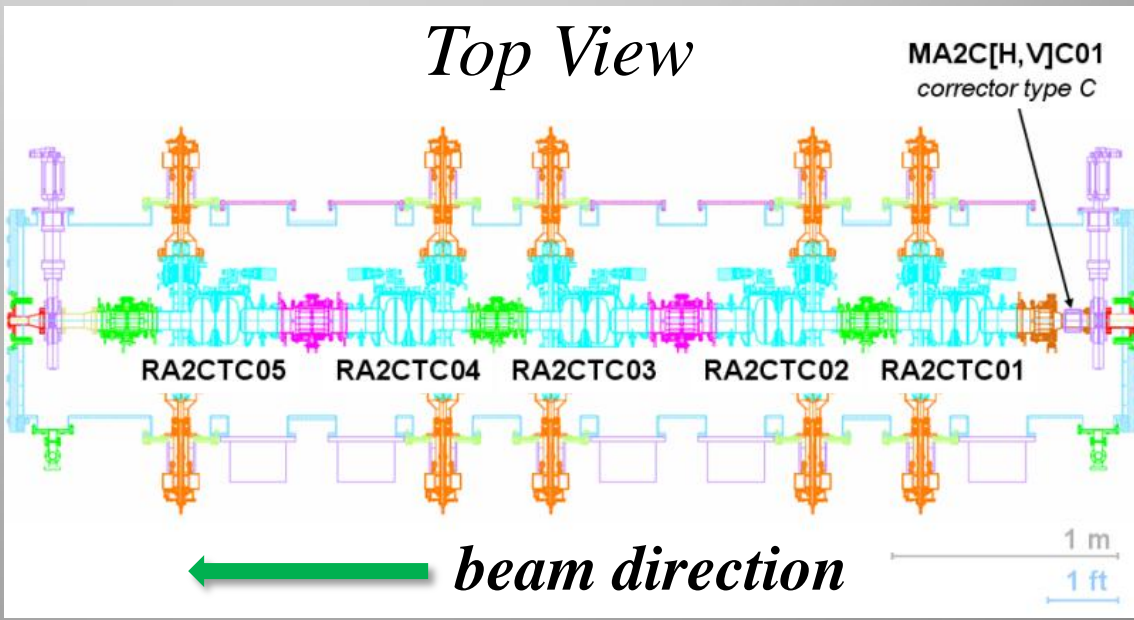
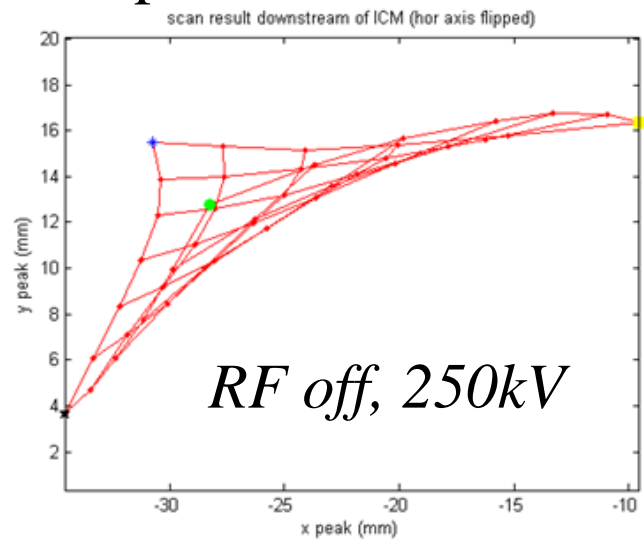



Localizing stray fields

- Using RF couplers with DC voltage applied to localize the bad field region

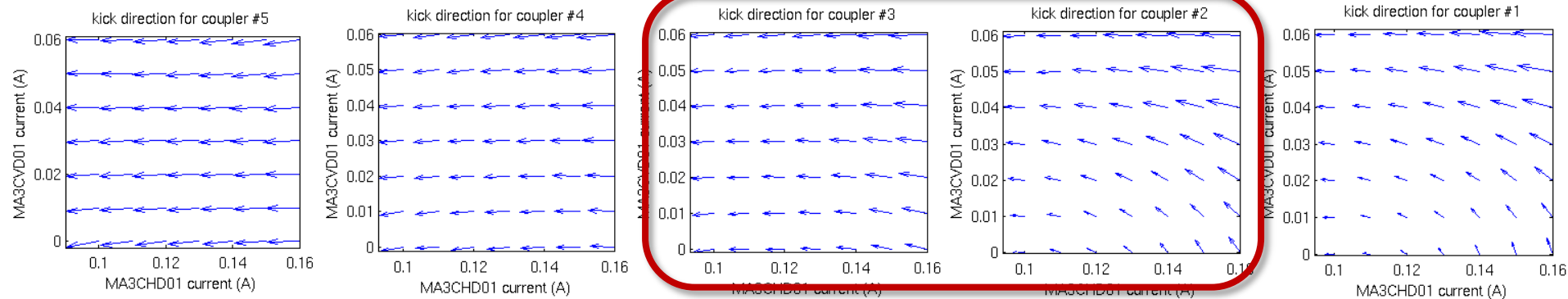
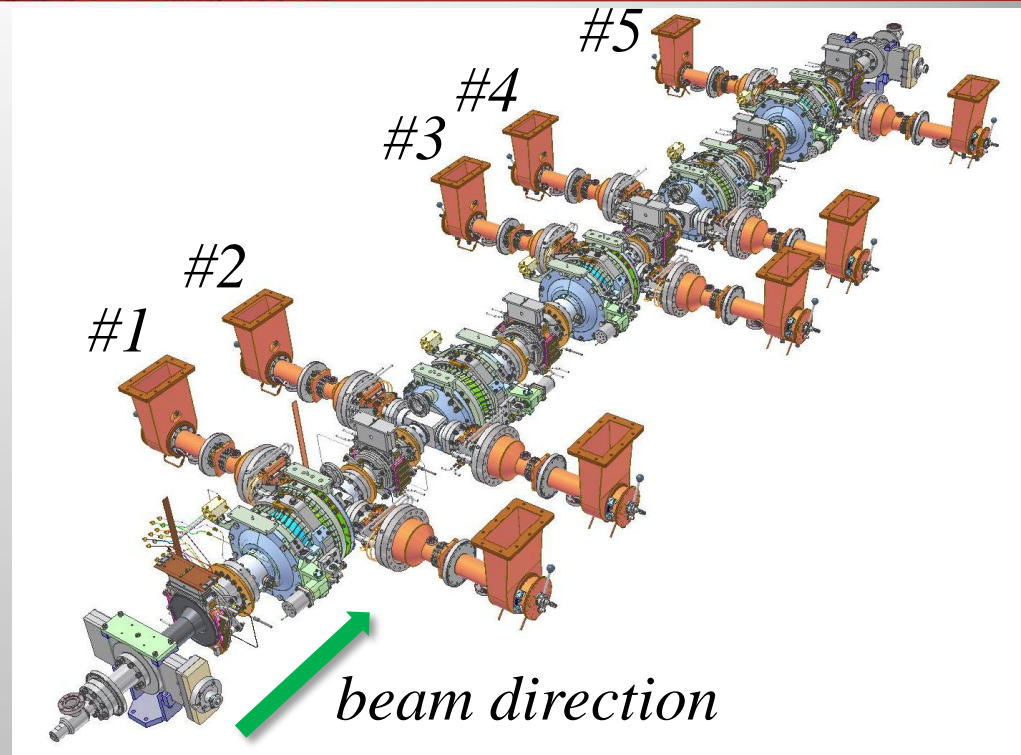



- RF emittance compensation
- Merger: chromatic effects with space charge
- High current: ion effect
- High current: long range wake fields



- Learned many valuable lessons from the gun operation despite low voltage & ceramic woes
- 11 months after 10 MeV injector installation complete and 10 months of initial beam running we are in the thick in commissioning
- Found some problems that require action
- Work in parallel on several new ceramics (an improved ceramic to arrive end of April) and second gun to reach 500kV



- John Barley, Sergey Belomestnykh, Mike Billing, Eric Chojnacki, John Dobbins, Bruce Dunham, Richard Erhlich, Mike Forster, Steve Gray, Colwyn Gulliford, Georg Hoffstaetter, Heng Li, Yulin Li, Matthias Liepe, Xianghong Liu, Florian Loehl, Valery Mejdizade, Dimitre Ouzounov, Hasan Padamsee, Peter Quigley, David Rice, Hisham Sayed, Valery Shemelin, Charles Sinclair, Eric Smith, Karl Smolensky, Charlie Strohman, Maury Tigner, Alexander Temnykh, Vadim Vescherevich, Frank Wise, and more...