



Wavefront sensing *or why do stars twinkle?*

Ivan Bazarov

Cornell Physics Department / CLASSE

Outline

- **Connection between optical phase & ray direction**
- **Complex index of refraction**
- **Shadowgraphy**
- **Shlieren imaging**
- **Phase contrast imaging**



Phase front in geometrical optics

Constant phase wavefront – by the eikonal equation, the **direction** of the rays is given by its gradient

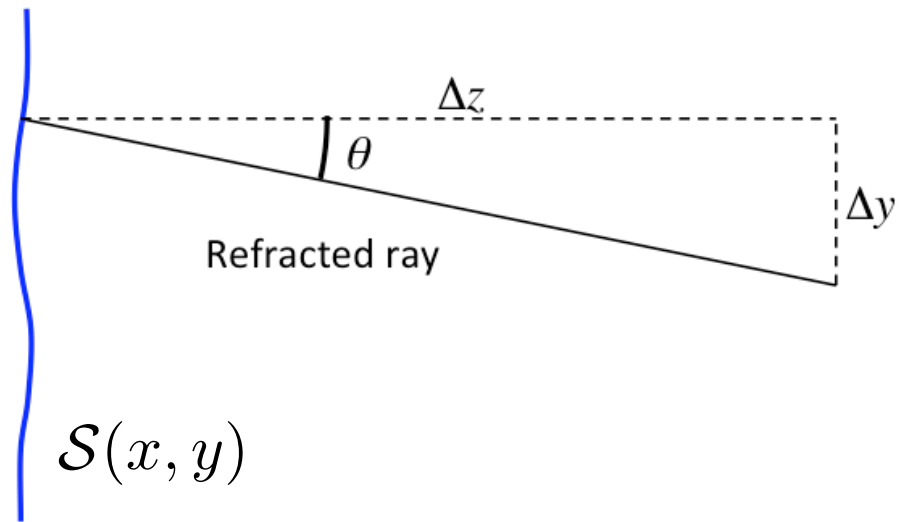
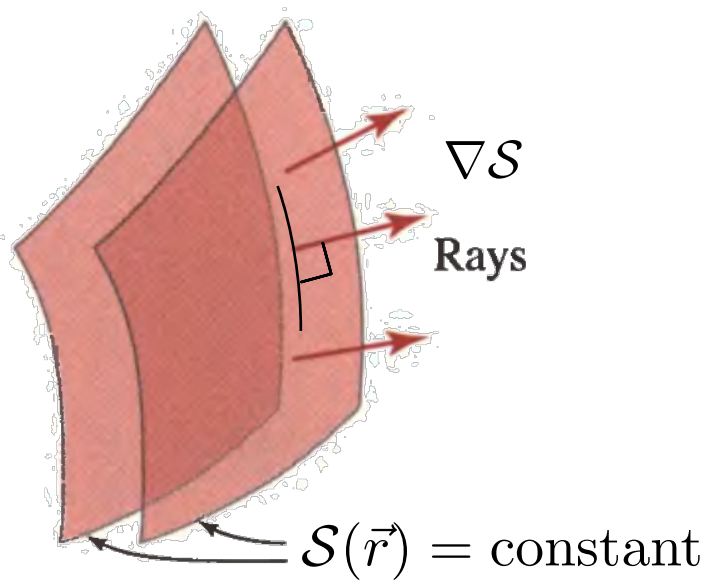

$$\theta_y \approx \frac{\Delta y}{\Delta z} \approx \frac{\partial S}{\partial y}$$



Phase vs. amplitude changes

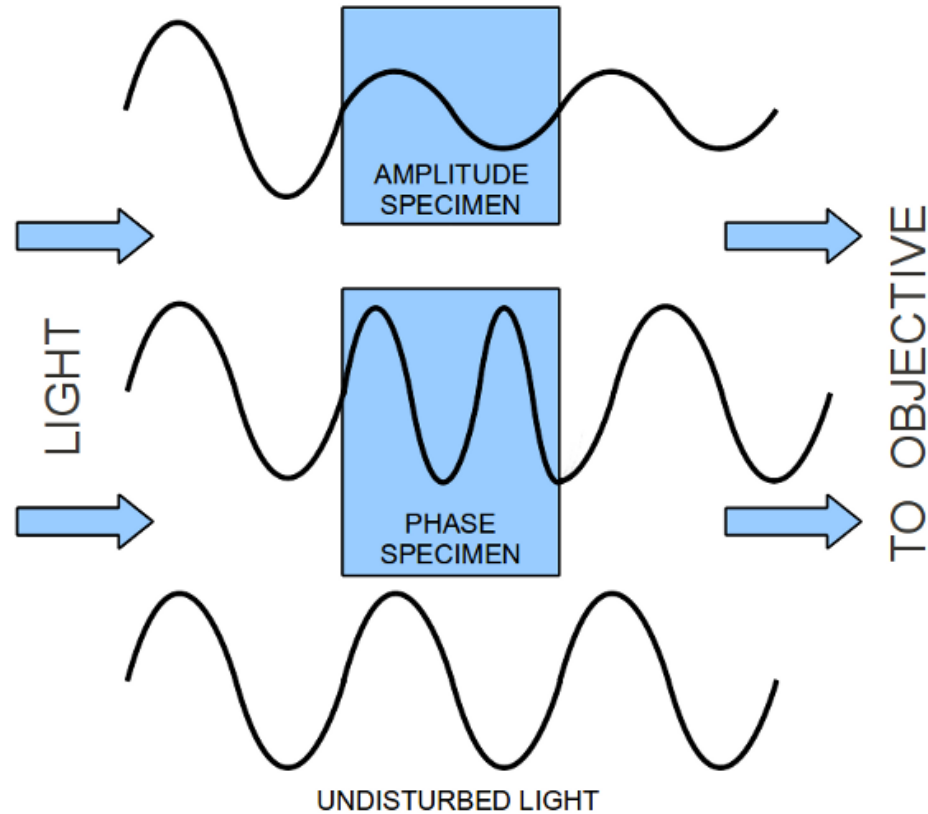

complex index
of refraction

amplitude

$$\tilde{n} = n + i\kappa$$

phase modulation



Complex index of refraction

$$\mathbf{E}(z, t) = \mathbf{E}_0 e^{i(\tilde{k}z - \omega t)} = \underbrace{e^{-2\pi\kappa z / \lambda_0}}_{\text{amplitude}} \mathbf{E}_0 e^{i(\underbrace{kz - \omega t}_{\text{phase}})}$$

$\tilde{k} = \frac{2\pi\tilde{n}}{\lambda_0}$

Thus, the intensity change is given by: $\frac{4\pi\kappa}{\lambda_0} \Delta z$

And the phase change (in rad) given by: $\frac{2\pi(n - 1)}{\lambda_0} \Delta z$

Fact of nature: for most transparent dielectrics $(n - 1) \gg \kappa$



Phase object: $(n-1) \gg \kappa$

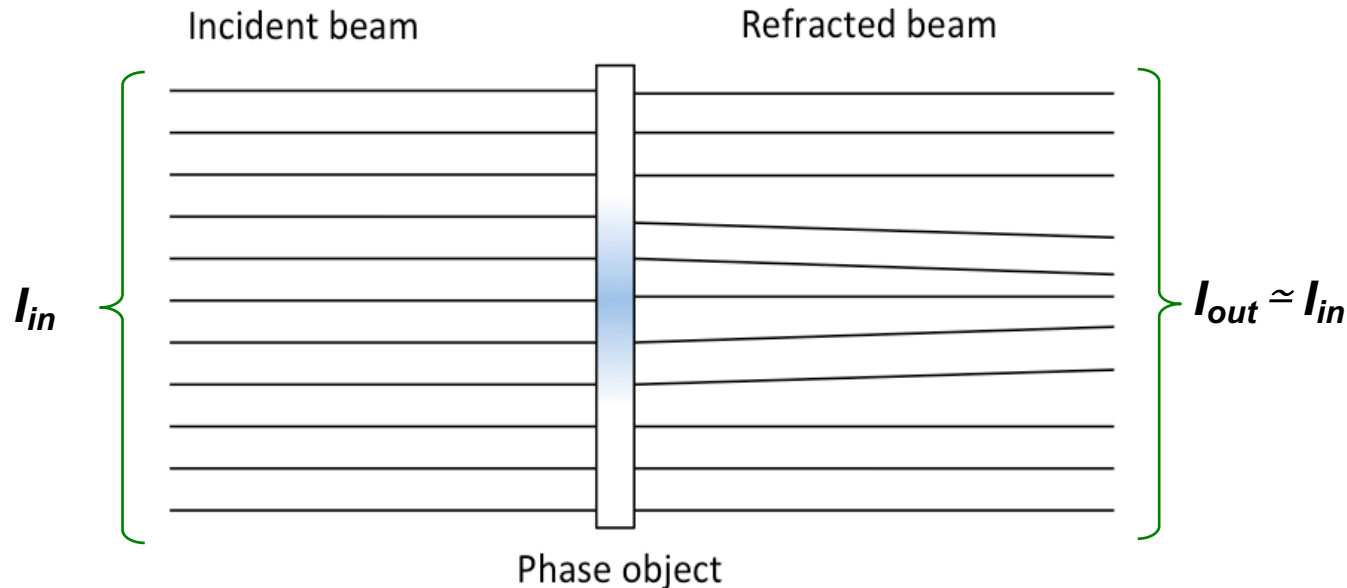

Intensity doesn't change, only directions of the rays do!

Temperature induced variations in gasses, liquids, thin biological objects, transparent films – all phase rather than amplitude objects



Problem with imaging of phase objects

When $B = 0$, all rays from a point x_{in} arrive at a point x_{out} , independent of angle.

$$\begin{bmatrix} x_{out} \\ \theta_{out} \end{bmatrix} = \begin{bmatrix} A & 0 \\ C & D \end{bmatrix} \begin{bmatrix} x_{in} \\ \theta_{in} \end{bmatrix} = \begin{bmatrix} A x_{in} \\ C x_{in} + D \theta_{in} \end{bmatrix}$$

$$x_{out} = A x_{in}$$

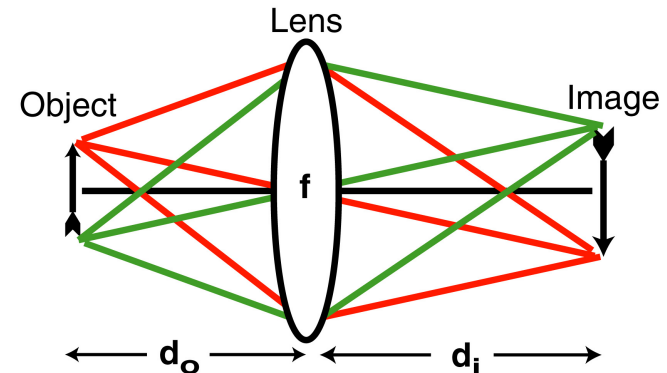

The *imaging condition* for ABCD matrix is $B = 0$, i.e. ray position in the image plane is *independent from* the angle (or phase) in the object plane.

Thus, phase objects are ***invisible*** when imaged directly!



Direct wavefront sensing: Hartmann-Shack

- Many ways exist to “image” or sense the wavefront, e.g. Shack-Hartmann

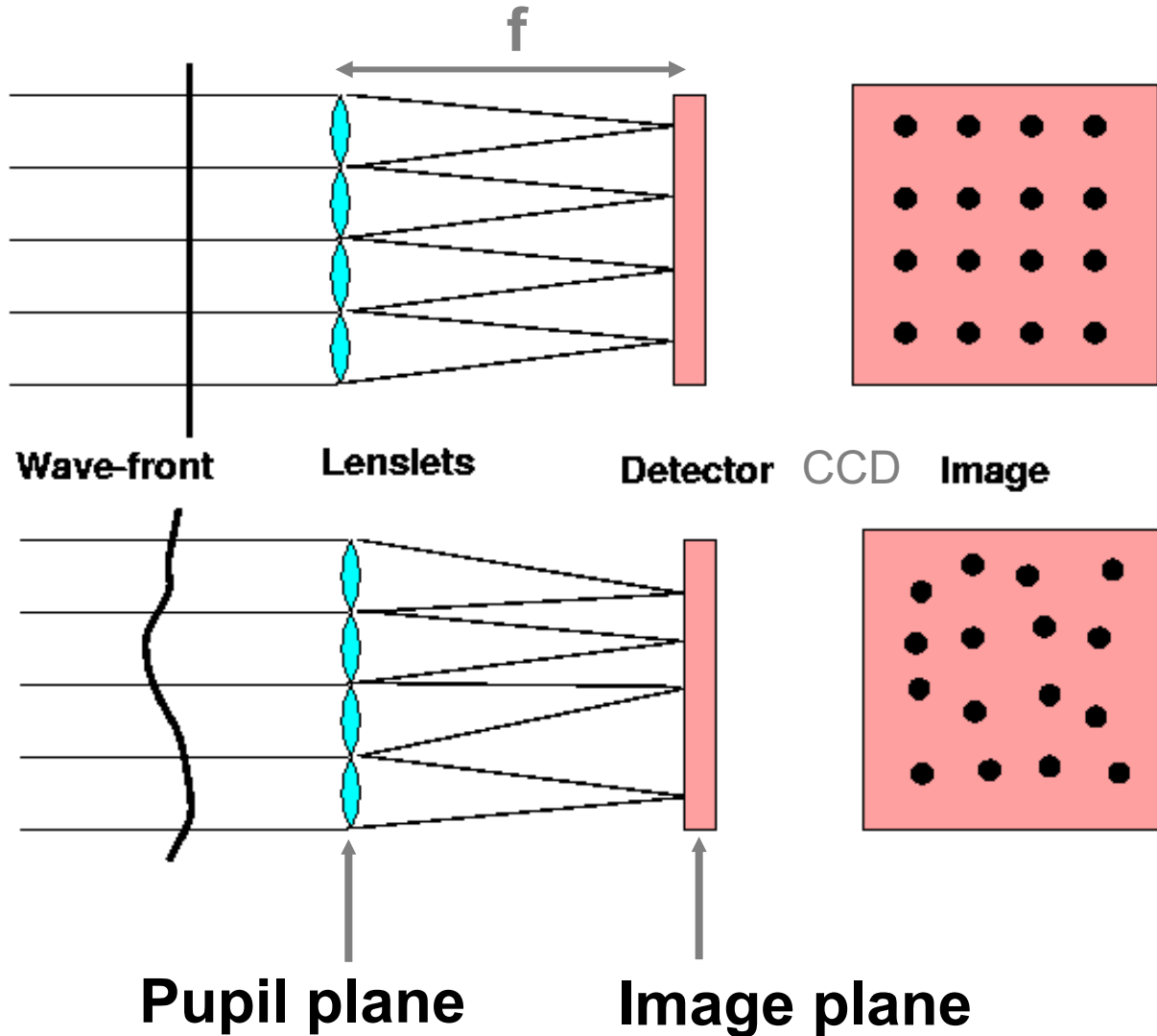

*Microlens arrays
in nature*

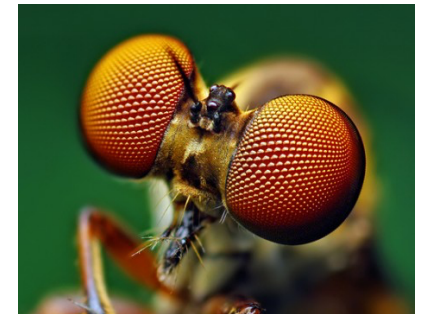



Shack-Hartmann

- If a plane wave incident: all spots from the micro-lens array form a perfect grid.
- When the wavefront is distorted, the spots shift measuring directly the wavefront angle.
- Can reconstruct the wavefront surface from the directly measured gradients

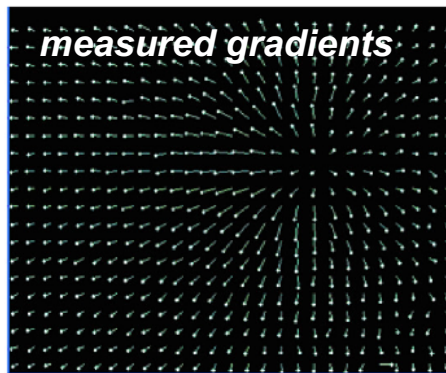
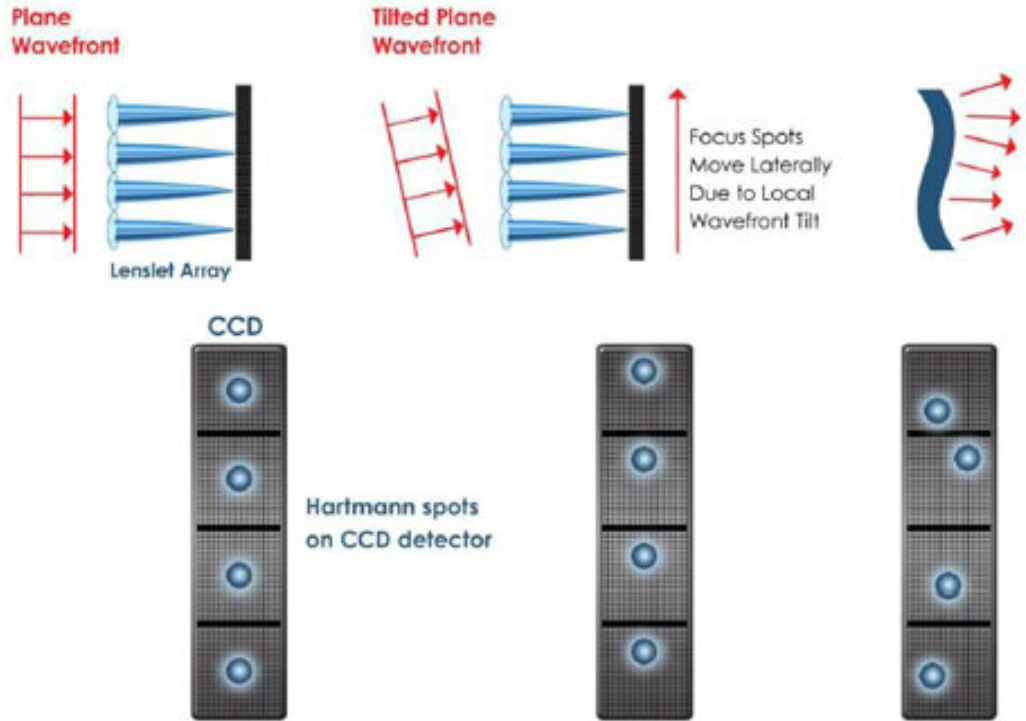

computer

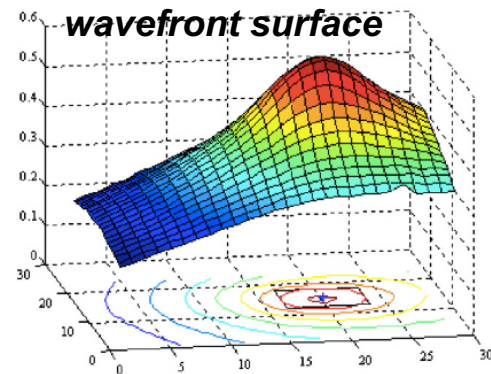



Angle change due to flat phase object is given by the derivative of the index of refraction

Refraction (angle change) will be due to the phase gradient (= **derivative**), with the phase itself related to the optical path: $n \times \text{thickness}$

Rays bend towards larger indexes of refraction (e.g. due to Fermat's principle).

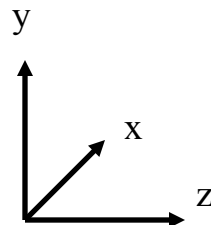

Increasing n

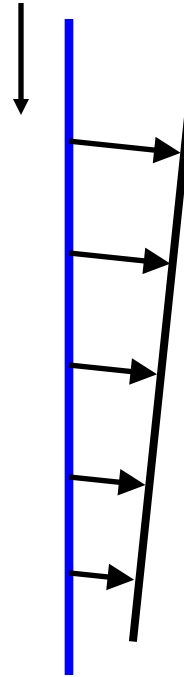

It's derivative, not n itself that determines the refraction angle.

after time = Δt

Negative vertical refractive-index gradient $dn/dy < 0$



Mathematical model

$dn/dy < 0$

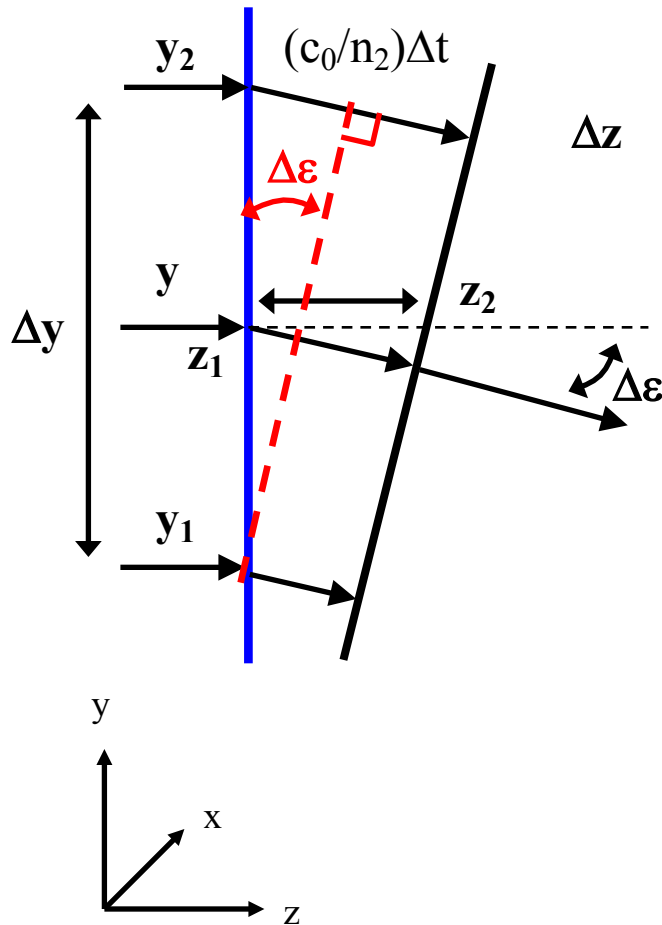

Distance wave front moves in time Δt :

$$\Delta z = c \Delta t = \frac{c_0}{n} \Delta t$$

Refraction angle:

$$\tan(\Delta \varepsilon) \approx \Delta \varepsilon = \frac{\left(\frac{c_0}{n_2}\right) \Delta t - \left(\frac{c_0}{n_1}\right) \Delta t}{\Delta y}$$

Also: $\Delta t = \Delta z \frac{n}{c_0}$

➔
$$\Delta \varepsilon = \frac{n(n_1 - n_2)}{n_1 n_2} \frac{\Delta z}{\Delta y}$$



Angle of refraction

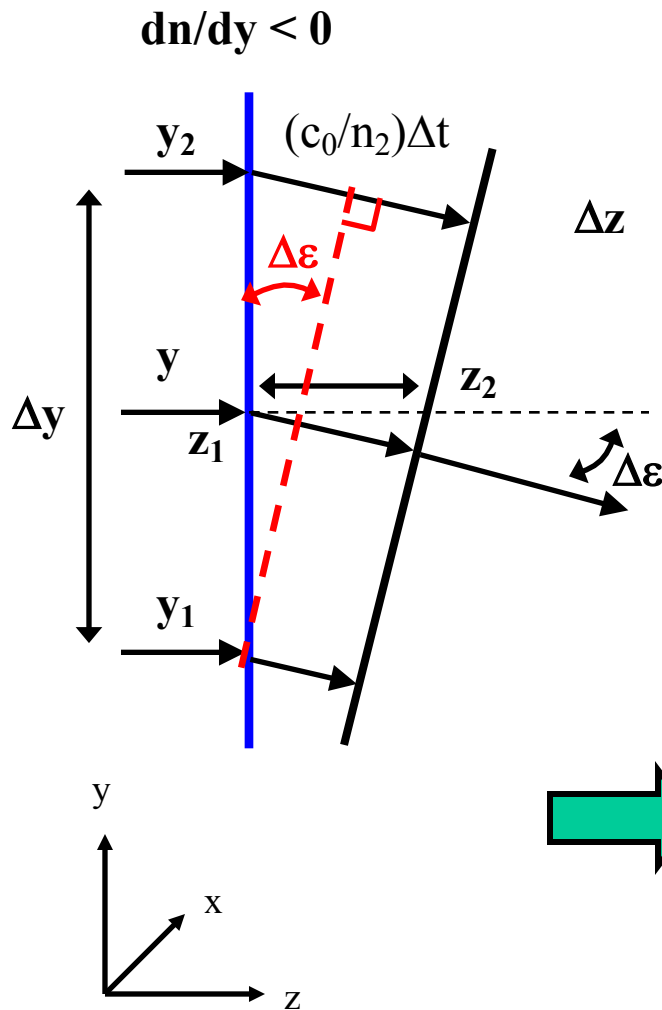

$$\Delta y \rightarrow 0, \Delta z \rightarrow 0$$

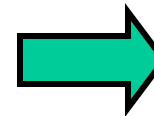

$$\frac{d\epsilon}{dz} = \frac{1}{n} \frac{dn}{dy}$$

Because ϵ is a very small angle, it is approximately equivalent to dy/dz , the slope of the refracted ray.

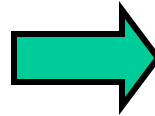

$$\frac{\partial^2 y}{\partial z^2} = \frac{1}{n} \frac{dn}{dy} \quad \text{and} \quad \frac{\partial^2 x}{\partial z^2} = \frac{1}{n} \frac{dn}{dx}$$

Curvature of refracted ray



Angle of refraction (contd.)

$dn/dy < 0$

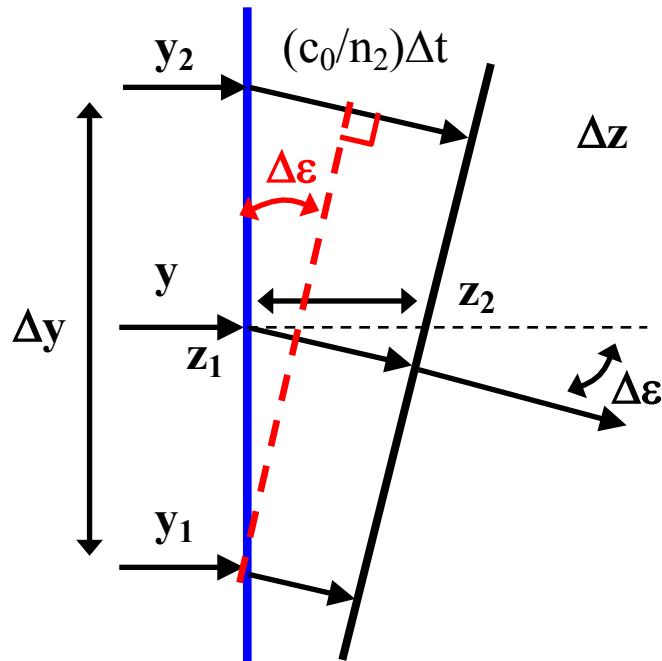

So the angular ray deflection in the x and y directions are:

$$\epsilon_y = \int \frac{1}{n} \frac{\partial n}{\partial y} dz \quad \text{and} \quad \epsilon_x = \int \frac{1}{n} \frac{\partial n}{\partial x} dz$$

Thus, two things that matter:

- *Derivative of the index of refraction*
- And/or *object thickness*



Shadowgraphy

Simplest way to visualize derivative of the index of refraction:

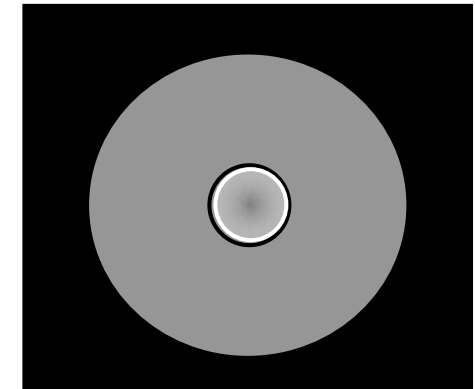
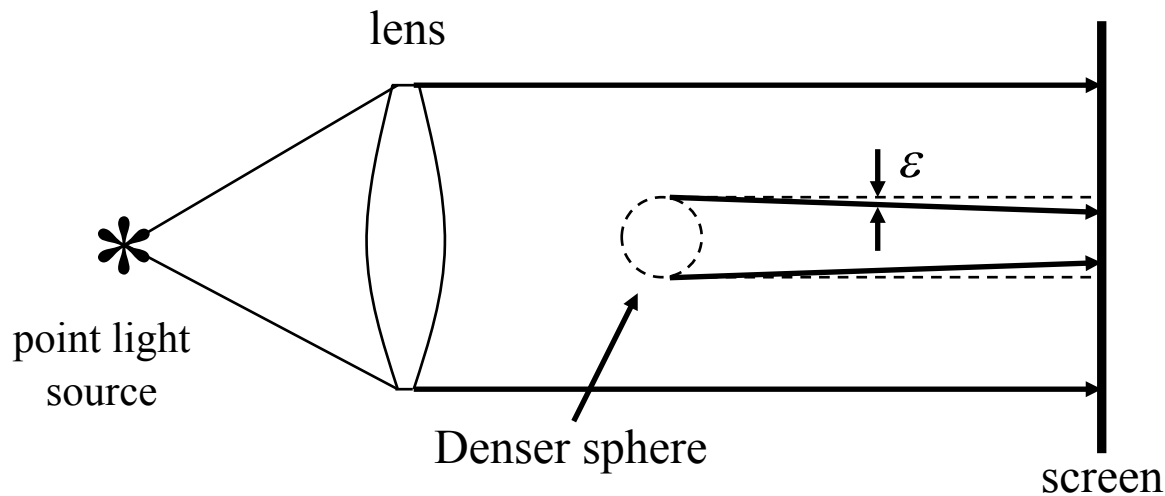
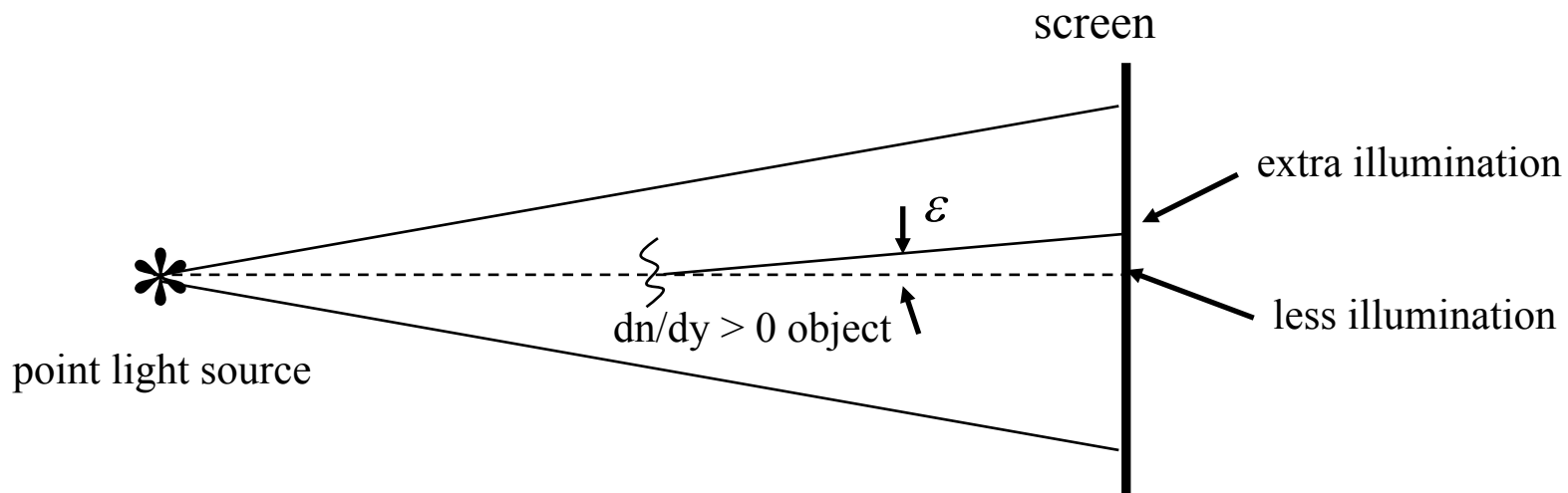

Screen



Shadowgraphy

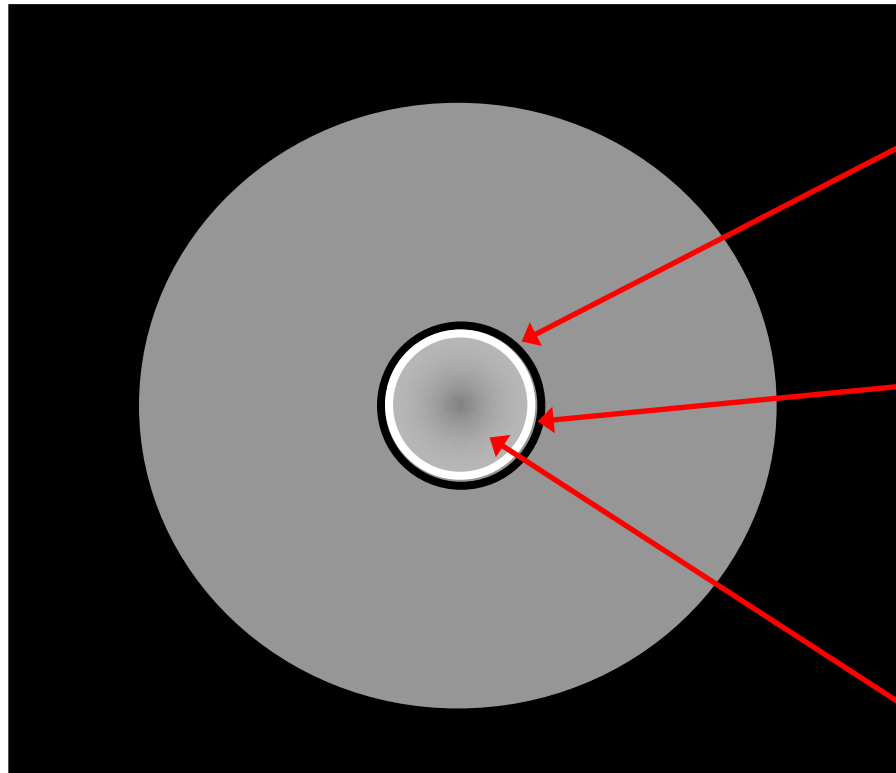

Screen

Dark circle due to light refracted from outline of sphere

Light circle due to refracted light from the outline illuminating this part of the screen

Gradient back to background illumination due to non-uniform refraction of rays as the light wave travels down the optical axis

Quality of the source & distance to the screen defines sharpness of features



Variations of gradients are critical!

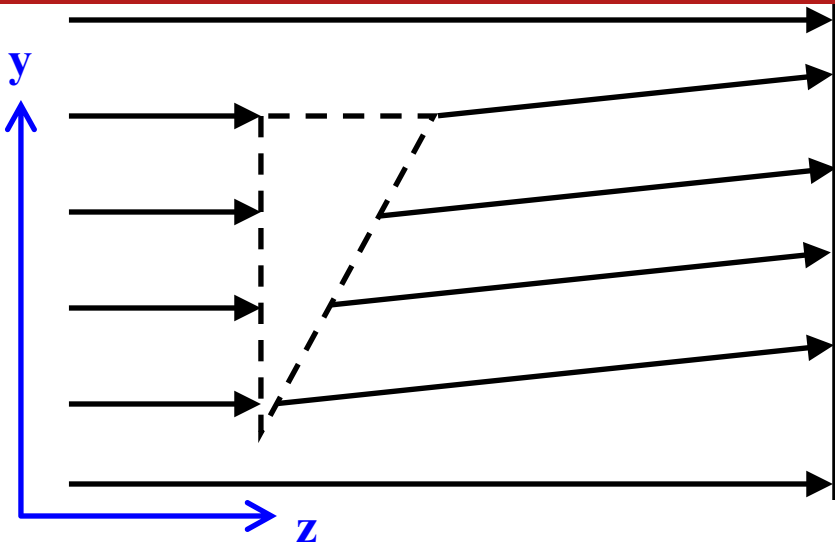

**Uniform shift
of illumination**

- see some shadow, but don't get outline of the phase object
- as move down optical path (z -direction),
$$\frac{\partial n}{\partial y} = \text{constant}$$
so all rays shift the same!

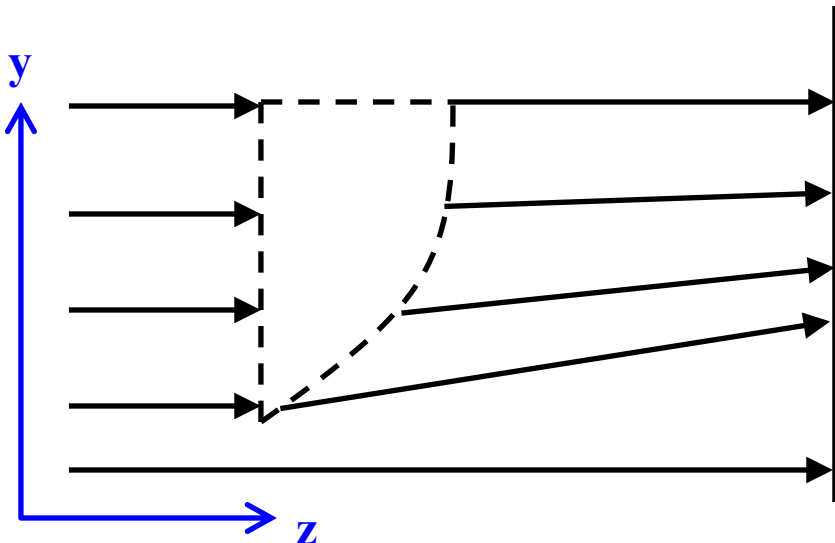

**Nonuniform
illumination**

- as move down optical path,
$$\frac{\partial^2 n}{\partial y^2} = \text{constant}$$
so rays shift non-uniformly.

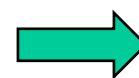

Variation of gradients critical for shadowgraphy!



Example shadowgraphs

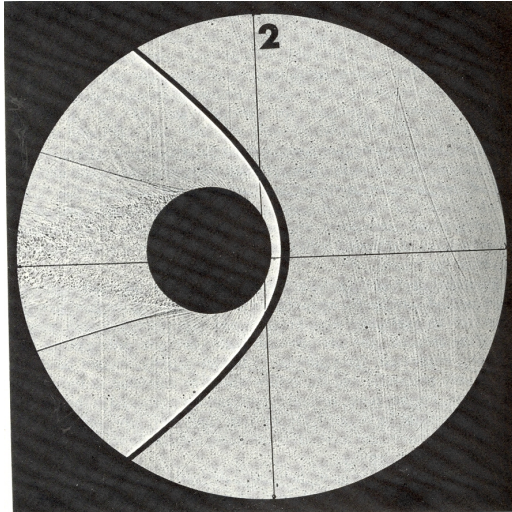

Sphere flying at $M=1.7$ (Merzkirch 1987)

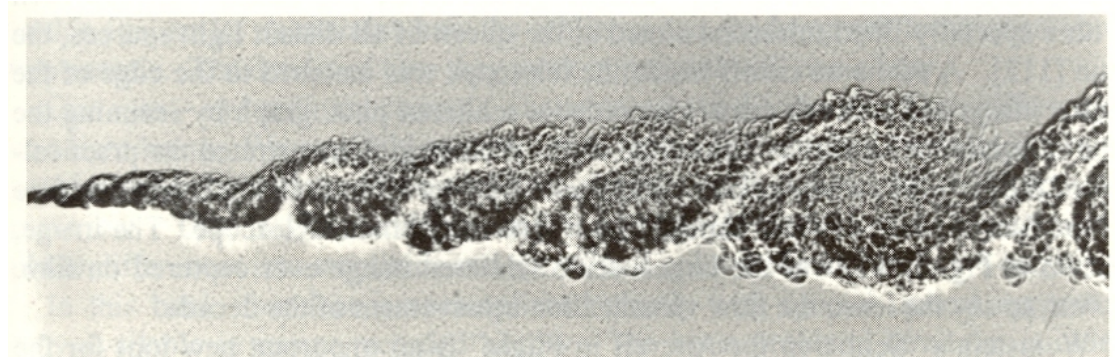

He/ N_2 mixing layer (Settles 2001)



Schlieren (ger. “*streak*”) Imaging

Schlieren Imaging

Focused optical image formed by a lens

Requires cutoff of the refracted light

Illumination level responds to $\partial n/\partial x$ and $\partial n/\partial y$

Schlieren image displays the deflection angle ε

More sensitive in general

More difficult to set up – uses lamps, mirrors, lenses

Shadowgraphy

Not an image but a shadow

No cutoff of refracted light

Responds to second spatial derivative, $\partial^2 n/\partial x^2$ and $\partial^2 n/\partial y^2$

Shadowgraph displays ray displacement

Less sensitive except for special cases (e.g. shock waves)

Extremely easy to setup, occurs naturally



Schlieren system – point light source

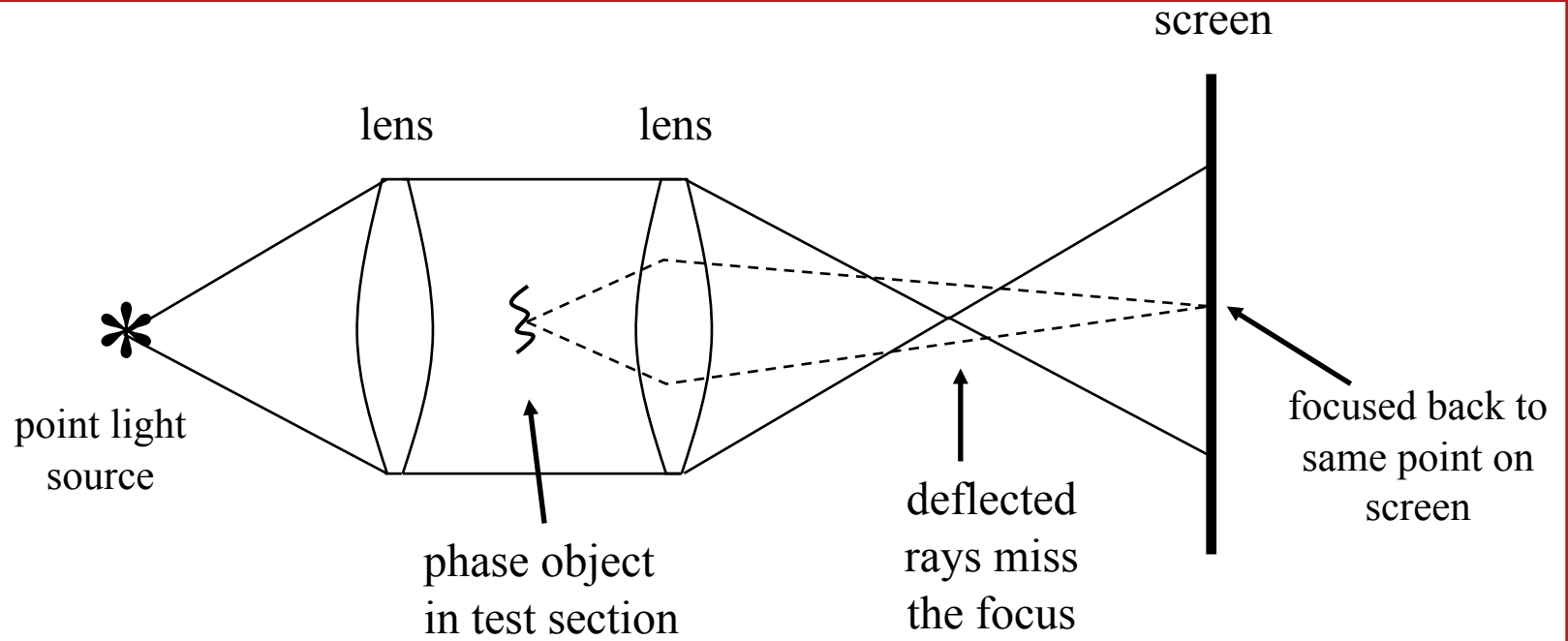

- merely a projector, imaging opaque objects in the test section



Schlieren system – knife block

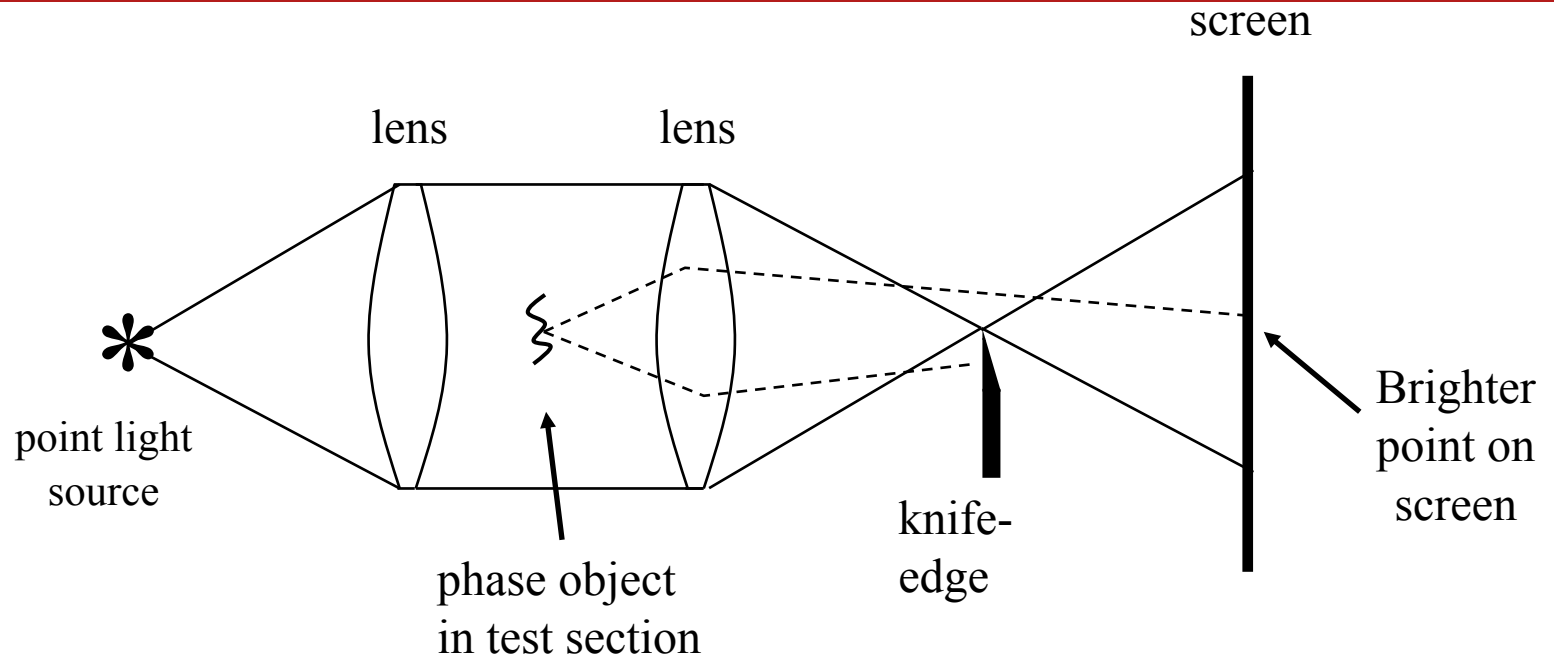

Detecting 1st derivative
 $\partial n / \partial y$

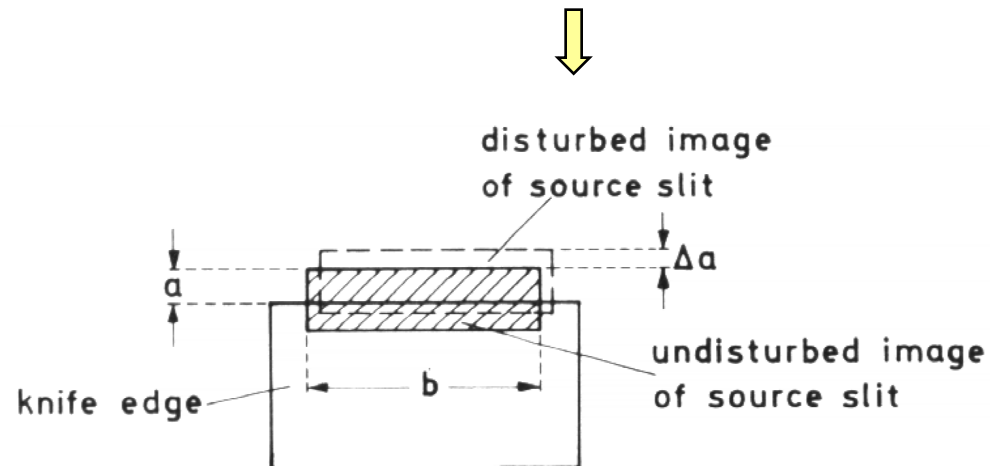



Some Schlieren images



Bullet and candle flame (Settles 2001)

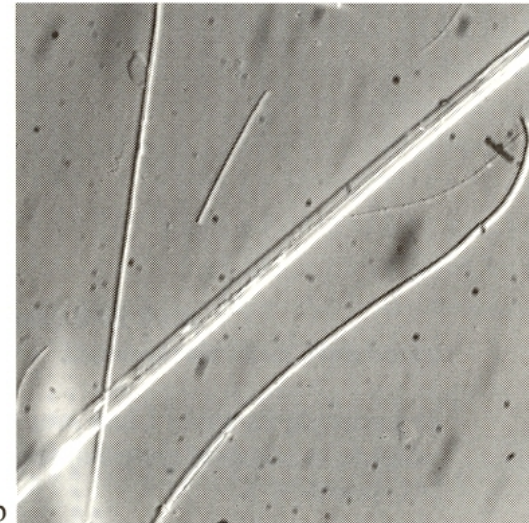

Glass fibers (Settles 2001)

a

b

Projectile fired at Mach 4.75 in reactive H_2 /air mixture – cyclic detonation behind the shock (Settles 2001)

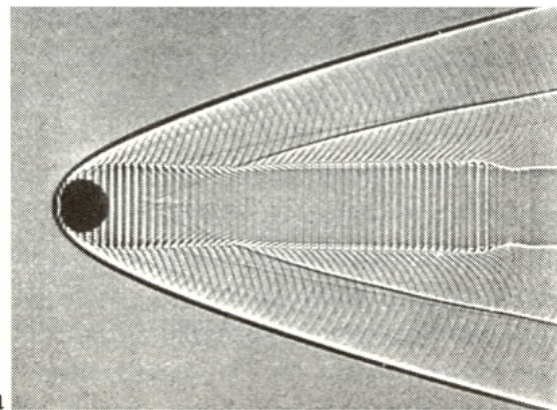

a

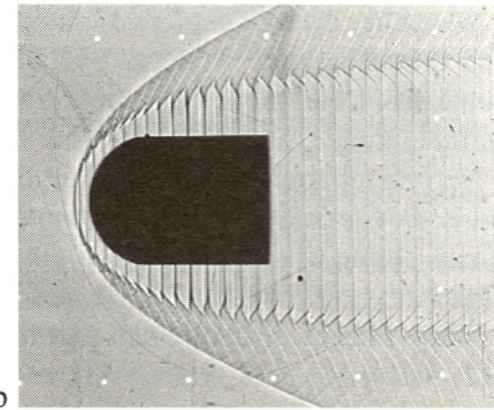

b



More Schlieren images



Removing frozen
pizza from case
(Settles 2001)

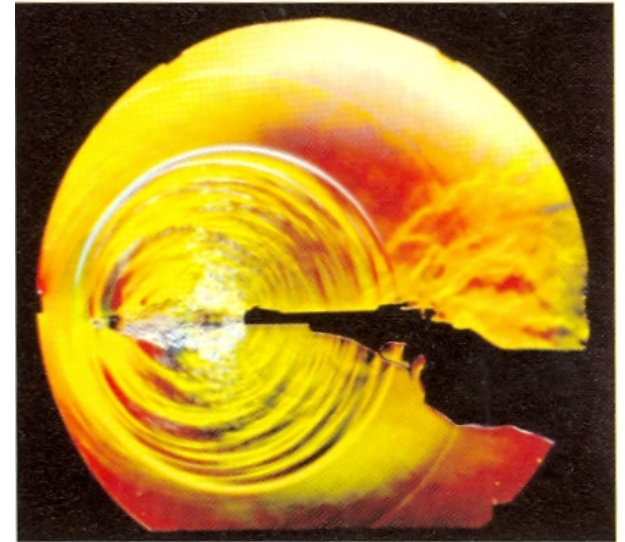

A gun firing 0.22
caliber bullet
(Settles 2001)

Heat from grill
(Settles 2001)





Phase sensitivity

In upcoming lectures: **interference** is the most sensitive way of detecting small phase changes.

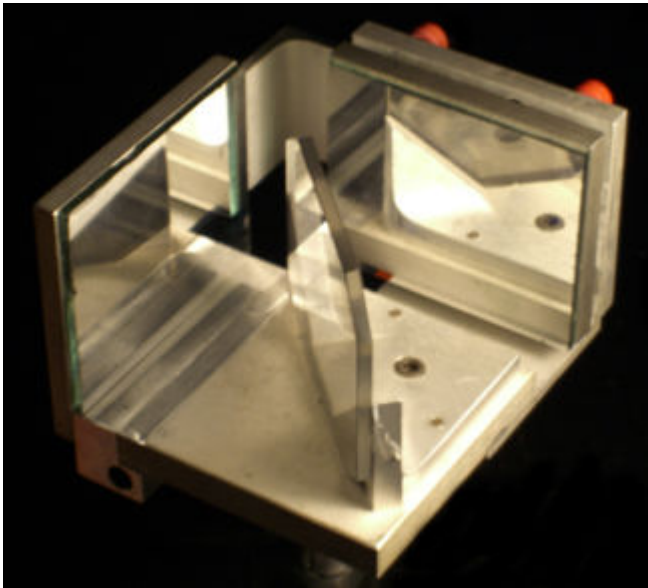

Michelson interferometer

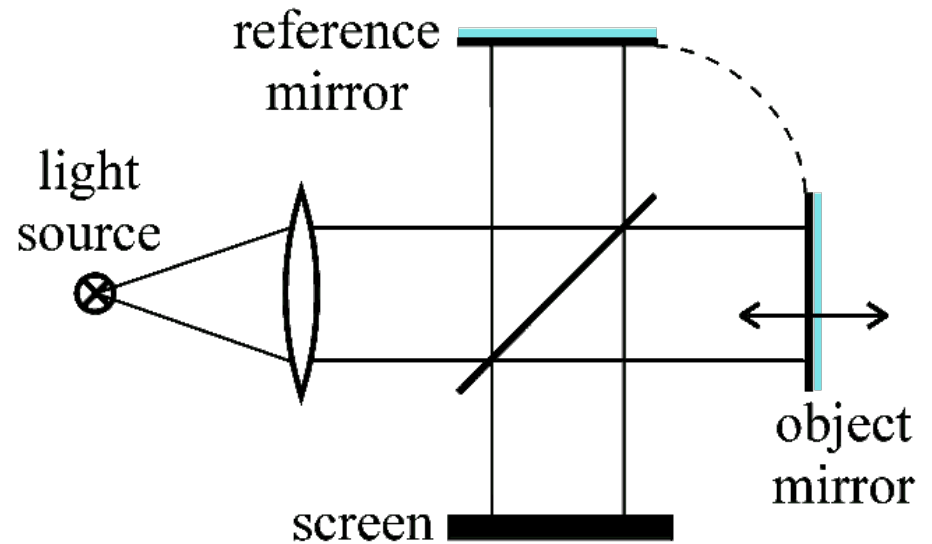



Amplitude vs. phase sensing in microscopy

Amplitude Objects:

Cells with stains, pigments, absorb, scatter light,
change its amplitude

Most biological objects do not absorb white light
But scatter & phase shift: phase objects

$$n \equiv \frac{c}{v_{\text{phase}}}$$

But may be hard to see with contrast by bright field

Use phase differences to visualize differences
in refractive index:

Phase contrast microscopy

Nobel Prize in 1953: Zernike



Working principle of phase contrast microscopy

Use the facts that scattered light: a) goes in all directions, b) is phase-shifted relative to the incoming light.

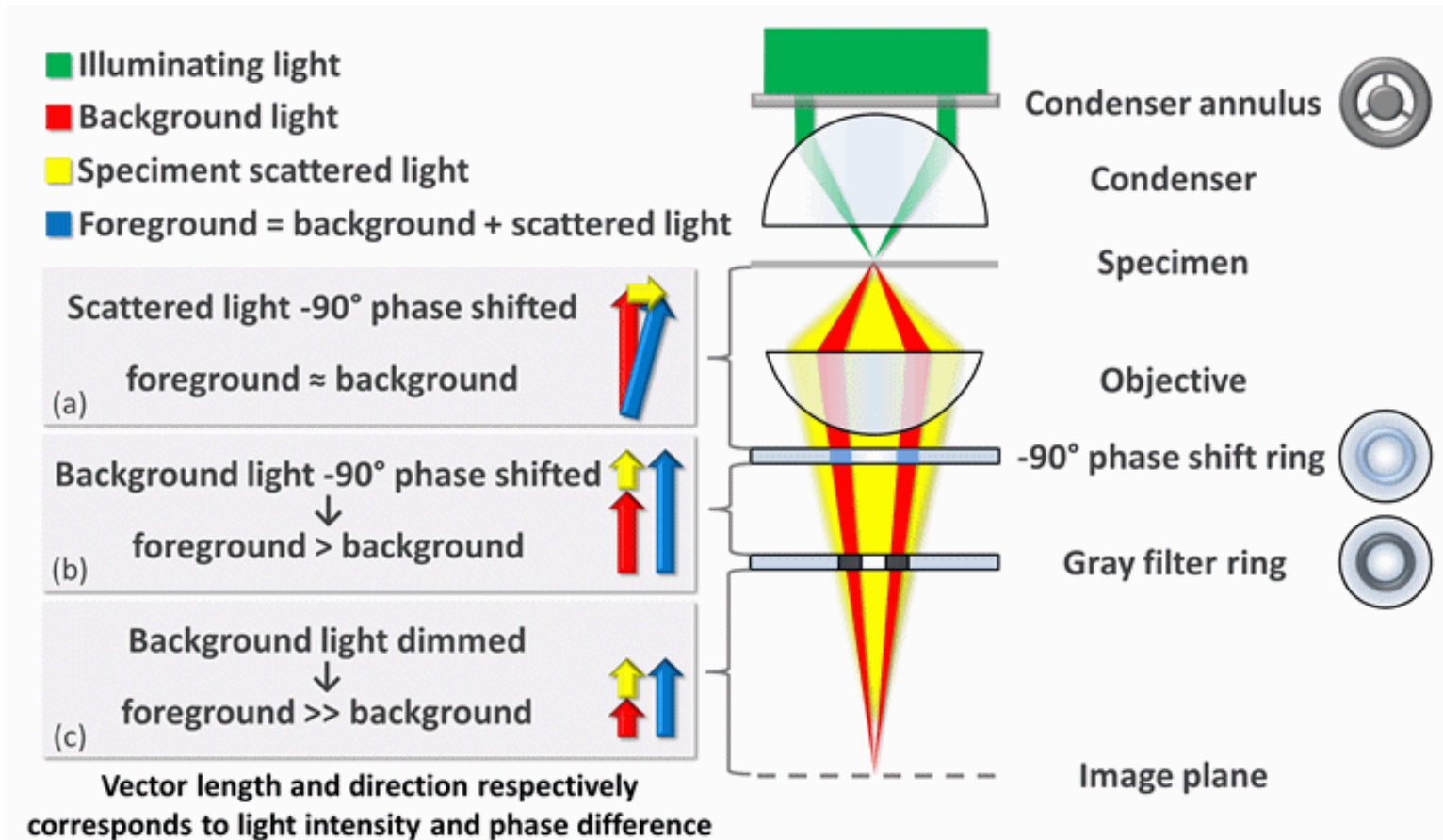



Amplitude vs. phase contrast images of living cells

<http://www.microscopyu.com/articles/phasecontrast/phasemicroscopy.html>

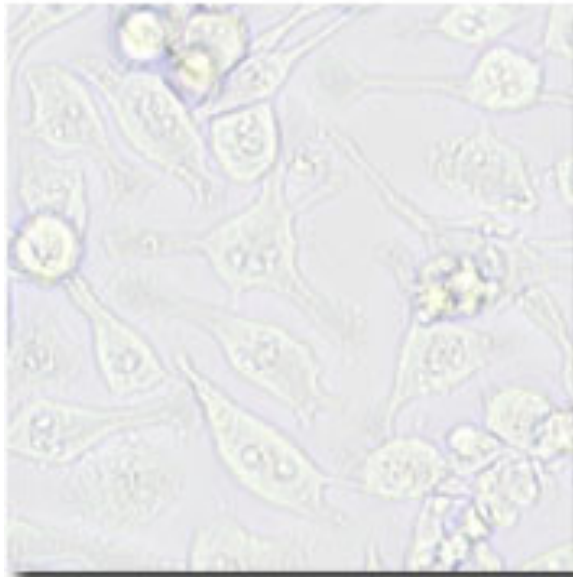

amplitude

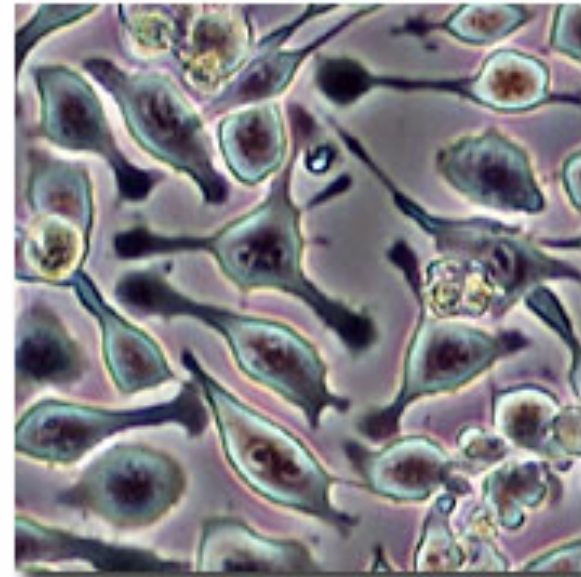

phase



Links/References

http://www.ucolick.org/~max/289/Lectures%20Final%20Version/Lecture%207%202013/Lecture7_2013_v1.ppt

http://galcit.caltech.edu/~sallym/schlieren_presentation.ppt

<http://www.ccam.uchc.edu/yu/class/Lectures/2.ppt>

Microlens array insect eye <http://www.newshonk.com/wp-content/uploads/2015/05/insecy-eye-e1269258069203.jpg>

Phase contrast microscope principle figure is taken from Wikipedia